

Aastra 7434ip

IP Phone for MX-ONE™

USER GUIDE



Aastra

Copyright

© Copyright Aastra Telecom Sweden AB 2012. All rights reserved.

No parts of this publication may be reproduced, stored in retrieval systems, or transmitted in any form or by any means, electronic, mechanical, photocopying, recording or otherwise, without prior written permission of the publisher except in accordance with the following terms.

If this publication is made available on Aastra media, Aastra gives its consent to downloading and printing copies of the content provided in this file only for private use and not for redistribution. No parts of this publication may be subject to alteration, modification or commercial use. Aastra will not be liable for any damages arising from use of an illegal modified or altered publication.

1

Important User Information

TRADEMARK

Aastra is a registered trademark of Aastra Technologies Limited. All other trademarks herein are the property of their respective owners.

DISCLAIMER

While every effort has been made to ensure accuracy, Aastra will not be liable for technical or editorial errors or omissions contained within this documentation. The information contained in this documentation is subject to change without notice.

DECLARATION OF CONFORMITY

Hereby, Aastra Telecom Sweden AB, Box 42214, SE-126 17 STOCKHOLM, declares that this product(s) is in conformity with the essential requirements and other relevant provisions of the European Directive 1999/5/EC (R&TTE Directive).



Details to be found at www.aastra.com/sdoc

FCC Statement

This equipment has been tested and found to comply with the limits for a Class B digital device, pursuant to Part 15 of the FCC rules. These limits are designed to provide reasonable protection against harmful interference in a residential installation. This equipment generates, uses and can radiate radio frequency energy and, if not installed and used in accordance with the instructions, may cause harmful interference to radio communications. However, there is no guarantee that interference will not occur in a particular installation. If this equipment does cause harmful interference to radio or television reception, which can be determined by turning the equipment off and on, the user is encouraged to try to correct the interference by one or more of the following measures:

- Reorient or relocate the receiving antenna.
- Increase the separation between the equipment and receiver.
- Connect the equipment into an outlet on a circuit different from that to which the receiver is connected.
- Consult the dealer or an experienced radio/TV technician for help.

HAC (Hearing Aid Compatible)

IMPORTANT SAFETY INSTRUCTIONS (ENGLISH)

When using your telephone equipment, basic safety precautions should always be followed to reduce the risk of fire, electric shock and injury to persons, including the following:

- Do not use this product near water, for example, near a bath tub, wash bowl, kitchen sink or laundry tub, in a wet basement or near a swimming pool.
- Avoid using a telephone (other than a cordless type) during an electrical storm. There may be a remote risk of electric shock from lightning.
- Do not use the telephone to report a gas leak in the vicinity of the leak.
- Use only the power cord indicated in this manual.

SAVE THESE INSTRUCTIONS

IMPORTANTES MESURES DE SÉCURITÉ (FRANÇAIS)

Certaines mesures de sécurité doivent être prises pendant l'utilisation de matériel téléphonique afin de réduire les risques d'incendie, de choc électrique et de blessures. En voici quelques unes:

- Ne pas utiliser l'appareil près de l'eau, par exemple, près d'une baignoire, d'un lavabo, d'un évier de cuisine, d'un bac à laver, dans un sous-sol humide ou près d'une piscine.
- Éviter d'utiliser le téléphone (sauf s'il s'agit d'un appareil sans fil) pendant un orage électrique. Ceci peut présenter un risque de choc électrique causé par la foudre.
- Ne pas utiliser l'appareil téléphonique pour signaler une fuite de gaz s'il est situé près de la fuite.
- Utiliser seulement le cordon d'alimentation indiqué dans ce manuel.

CONSERVER CES INSTRUCTIONS

INTRODUCTION

These directions for use describe the user procedures to handle the features available for the Aastra 7434ip phone.

This document is valid for MX-ONE Telephony System — Telephony Switch and MX-ONE Telephony System – Telephony Server. Whenever only one system is applicable, this is specifically stated in the document.

All the procedures, suffix digits, tone messages and times used in this document are according to the standard application system.

Not all exchanges are equipped with all features. By categorization, it is possible to vary the number of features assigned to each individual extension. This can affect the display information. The person or department responsible for telecommunications in your organization, will inform you of which features have been assigned to you.

The phone supports Dynamic Host Configuration Protocol (DHCP) for determination of IP addresses.

Note: Be careful not to keep credit cards near the phone, since they may be demagnetized due to the strong magnets in the phone.

This phone can be used without lifting the handset. When stated Lift the handset before dialling a procedure or a phone number you can also dial directly without lifting the handset.

Important Safety Instructions

Save these instructions. Read these safety instructions before use.

Note: When using your telephone or connected equipment, the following basic safety precautions should always be followed to reduce risk of fire, electrical shock and other personal injury.

Follow instructions in the equipment user guide or other documentation.

- Always install equipment in a location and environment for which it is designed.
- For mains powered telephones: Only operate with the mains power voltage indicated. If you are uncertain of the type of power supplied to the building, consult property management or your local power company.
- For mains powered telephones: Avoid placing the telephone power cable where it can be exposed to mechanical pressure as this may damage the cable. If the power supply cord or plug is damaged, disconnect the product and contact qualified service personnel.

- The handset's earcap region is slightly magnetic and may pick up small metallic objects, such as 26/6 gauge staples. Check the earcap region for metallic objects before use.
- Headsets used with this equipment must comply with EN/IEC 60950-1 and for Australia AS/NZS 60950.1-2003.
- Do not make any changes or modifications to equipment without seeking approval from the party responsible for compliance. Unauthorized changes or modifications could void the user authority to operate the equipment.
- Do not use the telephone to report a gas leak in the vicinity of the leak.
- Do not spill liquid of any kind on the product or use the equipment near water, for example, near a bathtub, washbowl, and kitchen sink, in a wet basement or near a swimming pool.
- Do not insert any object into equipment slots that is not part of the product or auxiliary product.
- Do not disassemble the product. Contact a qualified service agency when service or repair work is required.
- Do not use a telephone (other than cordless type) during an electrical storm.

Disposal of the Product

Your product should not be placed in municipal waste. Please check local regulations for disposal of electronic products.

2

Aastra 7434ip Description

The Aastra 7434ip phone (see figure below) has a three line display with 2 soft keys and 2 navigation keys. The phone also has a standard key pad, function keys, and 8 shortcut keys.

Most features are activated from the function keys and the menus shown in the display. For more information on function keys, see 2.3 Function Keys on page 13 and for the display, see 2.5 Display on page 15.

Note: Clean the phone with a cloth slightly moistened with a mild soap solution.

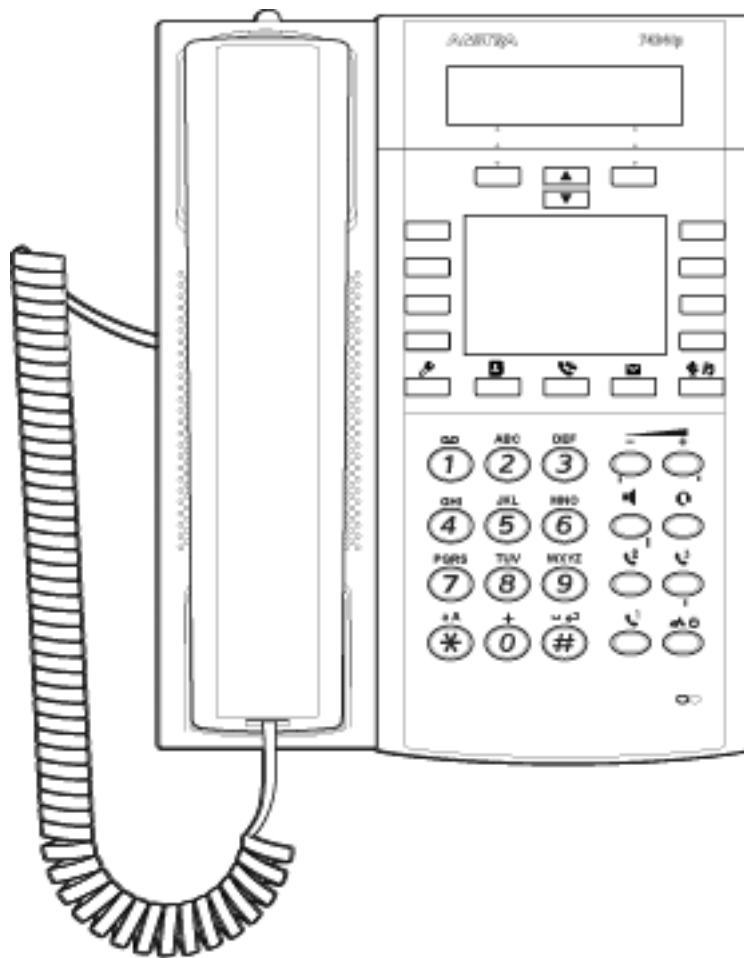

Figure 1: Aastra 7434ip Front View

2.1 Cabling

All connections at the back of the phone are marked for easier identification, see figure below.

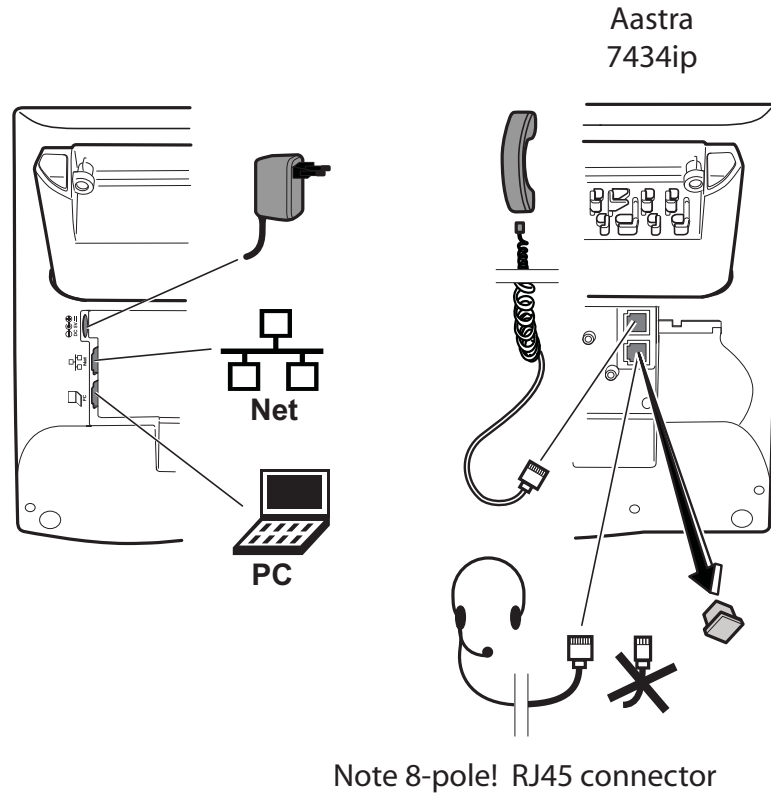
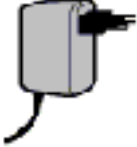

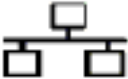









Figure 2: Aastra 7434ip Back View

Table 1 Phone Connections

Type of Connection	Description
	<p>Power inlet The phone is powered by an external AC/DC adapter (see details below) or, alternatively, over a Power over Ethernet (PoE) switch.</p> <ul style="list-style-type: none"> If you use the external power adapter, connect one end of the adapter to the phone connection marked , and the other end to a power outlet. If you use the PoE connection, you only have to connect the phone to the LAN.
	<p>LAN inlet Connect one end of the Ethernet cable to the phone connection marked Net, and the other end to a LAN connection. The phone conforms to the 802.1x standard for LAN authentication.</p>
	<p>If the phone is equipped with a gigabit Ethernet unit (DBY 412 02) and connected to a 1 gigabit LAN, it can be powered by a power adapter, or by a power ethernet switch.</p>
	<p>PC inlet Connect one end of the PC cable to the connection marked , and the other cable end to a RJ45 connection on your PC. When the phone is starting up (booting), a connected PC will lose network connection for a few seconds.</p>
	<p>Headset connector You can connect a headset to the connection marked . It is also possible to use a wireless headset. In case of using a wireless headset, connect the headset radio base to the  connector.</p>

	<p>Handset connector</p> <p>Connect the handset to the connection marked .</p>
	<p>Connect the Key Panel Unit or the Display Panel Unit to the connector marked "Panel".</p>

Note: The phone does not work during power failure, unless powered through a PoE.

The phone can be powered either from the network or from a 5 V AC/DC plug-in power adapter. Only use the plug-in adapter (power supply) listed below, or an adapter approved by your local retailer.

- RES 141 319/1 for the EU market except for the UK
- RES 141 319/2 for the US market
- RES 141 319/3 for the UK market

For other markets the power adapter can be locally sourced.

2.2 Foot Console

Your phone is equipped with a foot console. This console is available in two variants; it can be a stand only, or have a built-in option unit. For more information on option unit, see 2.12 Option Unit on page 27.

It is possible to adjust the angle of the phone by tilting the foot console, see figure below.

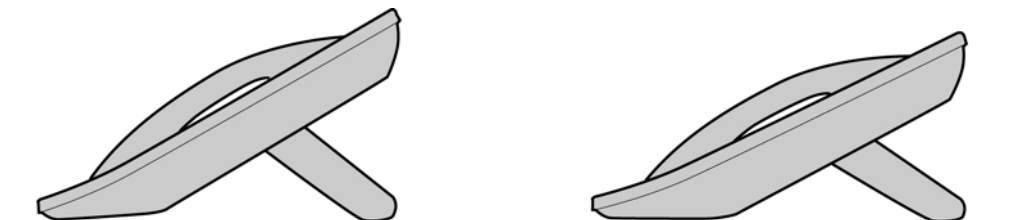
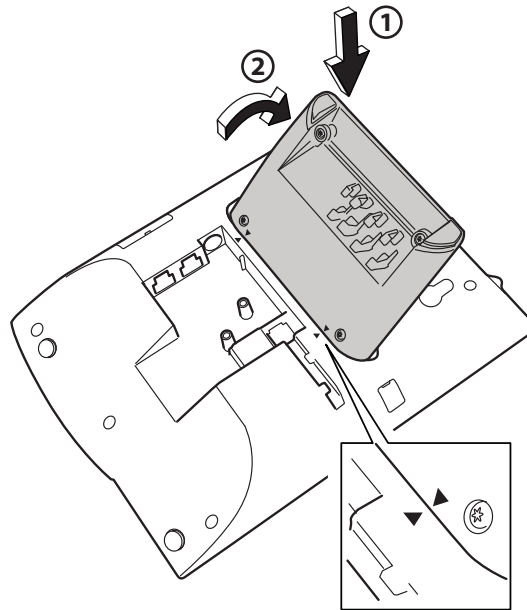

Figure 3: Tilttable Foot Console

To install the foot console, do the following:

1. Attach the foot at the arrows on the back of the phone.

2. Press until you hear a click sound.



Note: If you wish to remove the foot console, pull the console firmly towards you to release it before removing it from the phone.

3. Connect the cables, see 2.1 Cabling on page 9.
4. Attach the Electrostatic Discharge (ESD) cover on the back of the phone to protect the connectors from ESD. For this you need a screwdriver.

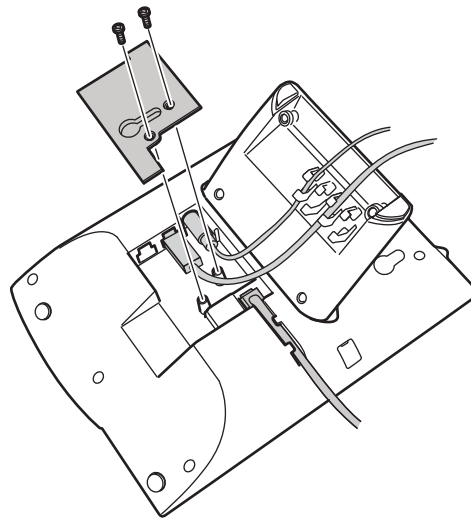

2.3 Function Keys

The phone is equipped with a standard alpha numeric keypad and a set of function keys. The function keys are described below.



Settings

Pressing this key opens the settings menu, see 13 Settings on page 96 for more information.



Contacts

Pressing this key opens the list of contacts in your phone. For more information on contacts, and what to do from this menu, see 8 Contacts on page 65.



Call List

Pressing this key opens the call list. The phone keeps a call list of 50 positions listing answered incoming calls, outgoing calls, and missed and rejected calls. Icons representing incoming, outgoing, and missed calls are displayed to the left of the number. For information on how to use the call list, see 5.4 Redial Calls on page 51.



Messages

Pressing this key opens the message menu.



Mute

Pressing this key during conversation, switches the microphone off.

If the key is pressed when the phone is in idle state, silent ringing is activated, and the indicator is on. Press any key to deactivate silent ringing.



Volume

Pressing the volume keys adjusts the volume level of the ring signal and incoming speech in the handset, headset, or loudspeaker.



Loudspeaker

Pressing this key enables handsfree connection.



Headset Pressing this key will enable headset connection. Press and hold down the headset key for 4 seconds to activate the headset preset mode. Leave the headset mode by pressing the *loudspeaker* key for 4 seconds (see above).



Line keys

The three line keys are available for both incoming and outgoing calls.



Clear, power on and off

Press this key to disconnect an ongoing call.



Pressing this key when working with from the menus, will take you one step back.

Press this key to shut down the phone, see 3.5 Shutting Down the Phone on page 37 or 3.4 Automatic Shut Down of the Phone on page 37.

2.4

Shortcut Keys

The Aastra 7434ip phone has eight programmable shortcut keys that can be assigned to:

- Functions (for example Callback and Follow-me)
- Monitored extensions (for more information, see 12.11 Monitoring Keys on page 92)
- Phone numbers or feature codes.

Note: All keys on the optional Key Panel Unit or Display Panel Unit are programmable shortcut keys.

Assigning phone numbers and feature codes to a shortcut key can be done by the user (or administrator) from the phone (see 13.2 Shortcuts on page 97) or from the phone's web interface (see 14.3 Using the Web Interface on page 110).

Assigning functions and monitored extensions to a shortcut key can only be done by the system administrator. Typically, the phone must be logged on to the telephony system to allow shortcut programming. (This is set by your system administrator.)

Note: Some of the shortcut keys have already been programmed by the system administrator when you receive the phone.

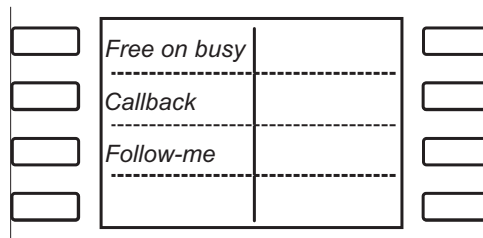

Figure 4: Shortcut keys with default settings

To use a function or a phone number programmed as a shortcut, simply press the key associated with the shortcut.

2.4.1 Designation Card Manager

Use the Designation Card Manager (DCM) tool to create your own designation cards with shortcut keys. DCM can be downloaded from www.aastra.com. For more information, please contact your Aastra Enterprise Certified Sales Partner.

2.5 Display

The phone display consists of three rows, each with 24 characters. The two uppermost rows display icons and text, conveying information about features, time and date, owner ID, and so on. The third row displays context dependent soft keys that you use to make selections in the display.

When a scroll bar is visible at the right in the display, there are more options than the ones currently shown. Use the navigation keys to scroll the list. The content depends on the traffic state and which actions are performed at the moment.

The display is tiltable, allowing you to change the angle of the display by pulling its upper part towards you, see figure below.



Figure 5: Tilttable display

It is possible to change the contrast of the display, see 13.4.1 Modifying Contrast on page 102.

It is also possible to change the brightness of the display, see 13.4.2 Modifying Brightness on page 103, and the brightness hold time, see 13.4.3 Modifying Brightness Hold Time on page 104.

You can also change the display menu language and the date and time presentation, see 13 Settings on page 96.

Note: All names and numbers presented in the displays in this user guide are examples.

2.5.1

Idle phone (idle mode)

When the phone is in idle mode, the display shows the time and date information on the first row, and your name or extension number on the second row.

14 May 2010	16:45
12345 John	
more...	Availability

If you have unanswered calls, these are indicated in the idle phone display.

1 Missed	16:45
12345 John	
more...	Availability

If follow-me is activated, this is also indicated in the idle phone display.

FollowMe To 54321	16:45
12345 John	
more...	Availability

2.5.2 Outgoing call





During an outgoing call, the display shows the traffic information and the dialed name (if available) or the number.







12345	16:45
Anna	0:02:18
more...	Hold

2.5.3 Display Icons

Depending on the phone mode, one or more icons in table 2 on page 17 may appear in the display.

Table 2 Display Icons

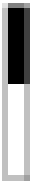
Display icon	Description
	Volume level bar Indicates the ring signal volume in idle or ringing mode, or in speech mode, the loudspeaker or earpiece volume.
	Security Indicates that the ongoing call is secure between the A and B party. The media (speech) and the signalling are encrypted.
	Access warning Flashes when the access to system services is reduced (some system services do not work).
	Headset preset Indicates that the phone is set for incoming and outgoing calls to be connected to the headset when you answer or make calls without lifting the handset.

Display icon	Description
	<p>New missed call(s) Indicates new missed and not checked incoming call(s). The number beside the symbol indicates how many times this caller has tried to call your extension.</p>
	<p>Missed call(s) Indicates new missed but checked incoming call(s). The number beside the symbol indicates how many times this caller has tried to call your extension.</p>
	<p>Incoming call Indicates an answered incoming call.</p>
	<p>Outgoing call Indicates an outgoing call.</p>
	<p>Bar indicator Indicates the shown part of the total list and where it is positioned in the total list.</p>
	<p>Setting indicators Filled symbol indicates the current setting in the shown list.</p>

2.6 Display Menu Structure

In the sections below, the phone menus are described in brief. For a detailed description of the various menu options, please see the appropriate section in this manual.

Note: Depending on the phone configuration, the menus in your phone may differ in content from the menus displayed in the following sections.

2.6.1 Idle Mode

When the phone is in idle mode, soft keys **more...** and **Availability** are shown. See figure below for a description of which features are available when you press either the **more...** or **Availability** key.

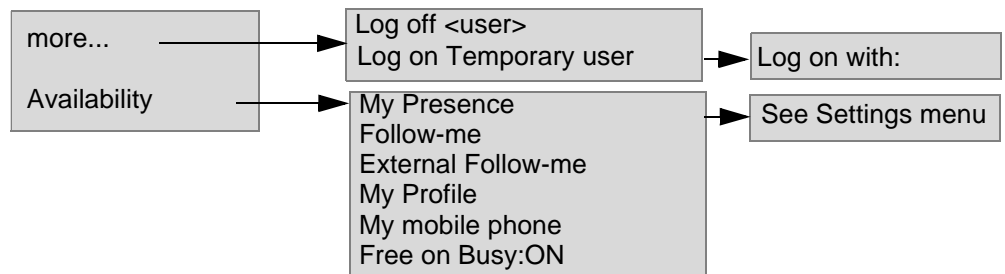



Figure 6: Idle menu structure

2.6.2 Settings

Pressing the  key activates the **Settings** menu. See section 7 Settings menu structure on page 20, for a description of the menu structure.

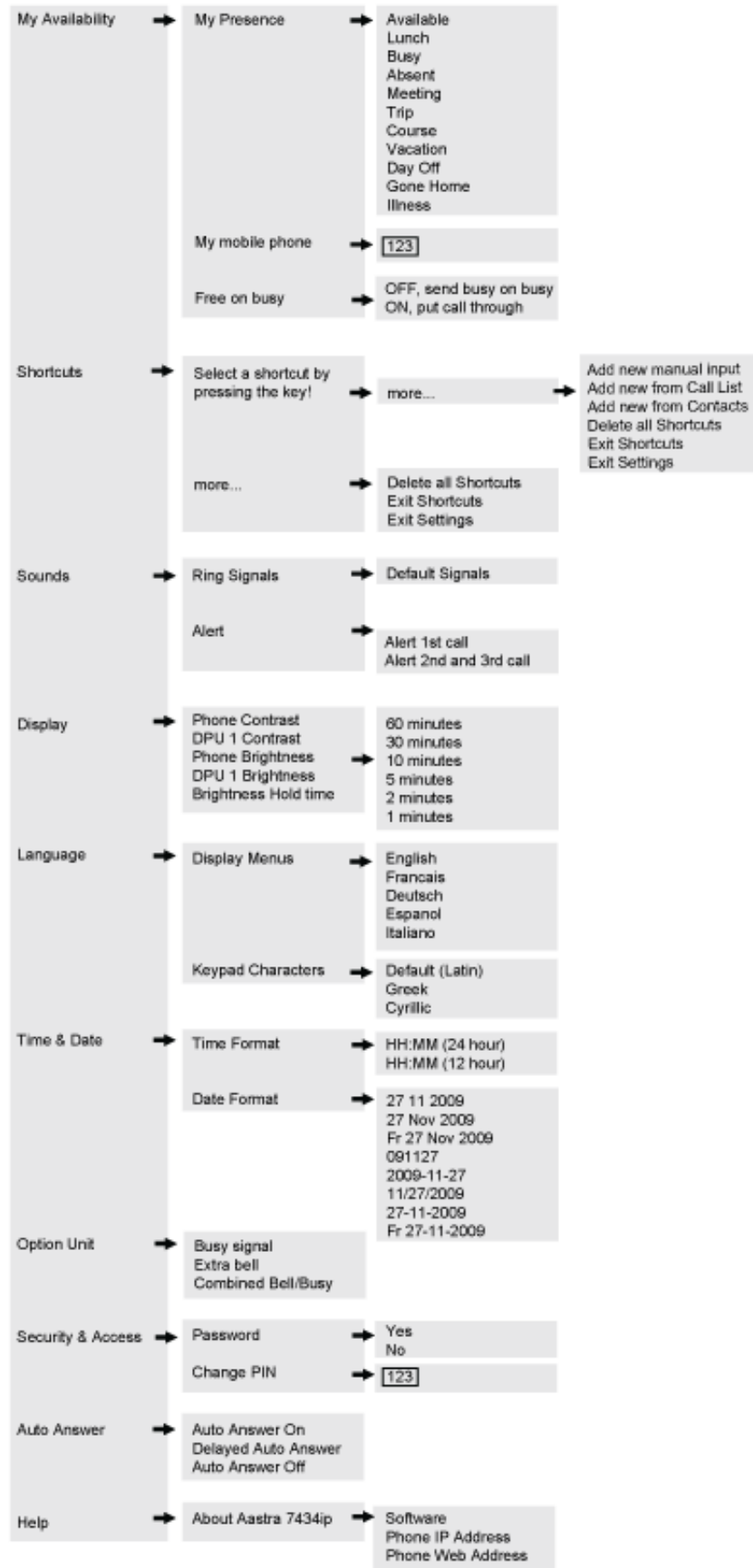



Figure 7: Settings menu structure

2.6.3 Contacts

Pressing the  key activates the **Contacts** menu. See figure below for a description of the menu structure.

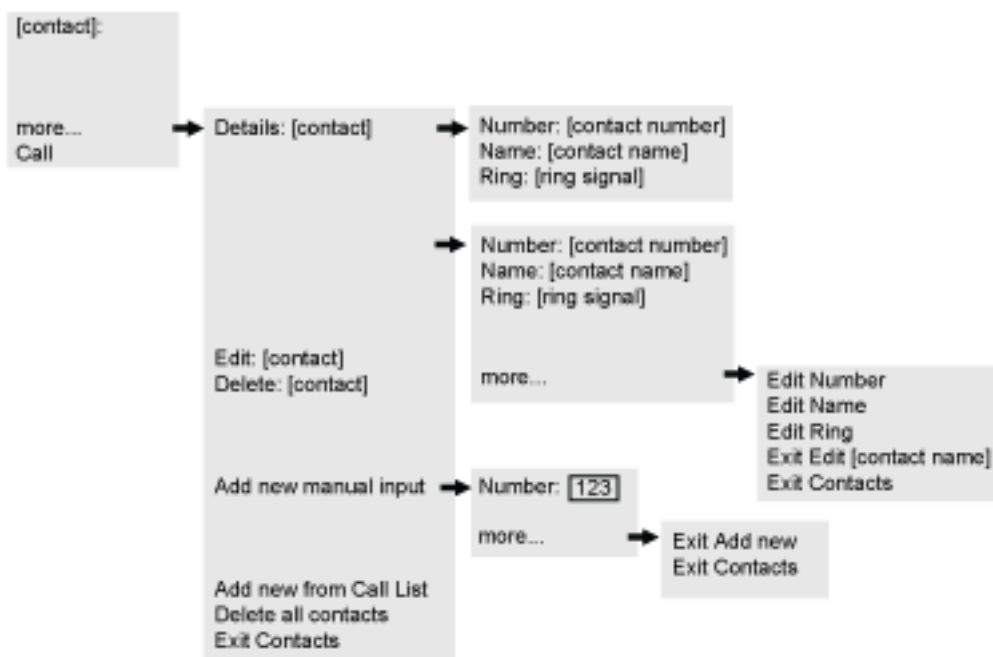



Figure 8: Contacts menu structure

2.6.4 Call List

If there is a missed call, the lamp at the  key is flashing and there is an information text in the display.

Press the  key to look in the **Call List**.

If you have missed calls, these will be shown and if you also want to check the outgoing and answered incoming calls, press **more...** and **Show all calls**. You can switch back to the list with missed calls by pressing **more...** and **Show missed calls**.

The figure below shows the different options in the call list.

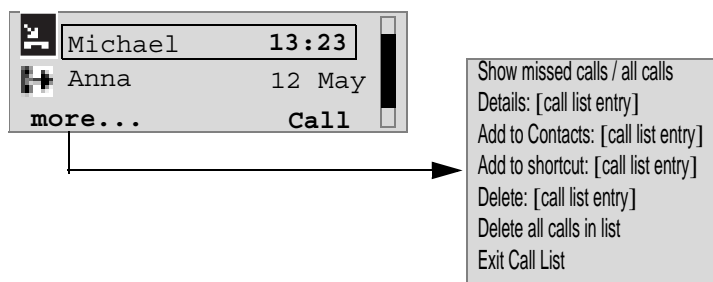

Figure 9: Call list menu structure

2.6.5 Messages

Pressing the  key activates the **Messages** menu. See figure below for a description of the menu structure.

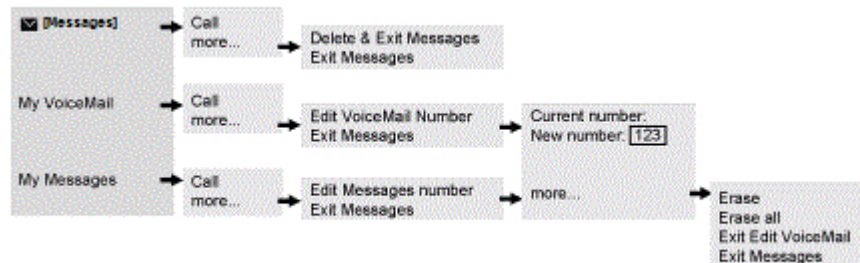

Figure 10: Messages menu structure

2.7 Indicators

Indicators on the phone keys indicate line status using different flash patterns, see below.

Off

The feature is not active.

Steady light

The feature is active.

Steady light can also indicate that a feature or setting is being programmed.

Slowly flashing

The line (or feature) is put on hold.

Can also indicate a shortcut currently being programmed.

Rapidly flashing

An incoming call.

Can also indicate an error.

Light with short breaks

Ongoing call.

2.8 Tones and Signals

It is possible to set different ring signals on the phone. For a description on how to change signals, see 13.3.1 Changing Ring Signals for Incoming Calls on page 100. To distinguish between different call types, that is, internal, external and callback calls, the signal you choose is used with different ring cadences, see 2.8.1 Call Type Characteristics on page 23. It is also possible to distinguish between callers by assigning contacts their own ring signal, see 8.3 Editing a Contact on page 67.

One other option is to use a melody instead of the ring signal, see 13.3.1.1 Downloading Melodies on page 101.

2.8.1 Call Type Characteristics

The ring signal for incoming calls alert in three different ways depending on the type of incoming call. The signals shown in this section are the most used signals worldwide. Many markets use signals that are adapted for the local standards. If you get a signal that is not described or you cannot identify, ask the system administrator.

Note: At a second incoming call, the phone rings only the first period and with a low level by default. The alerting type can be changed, see 13.3.2 Alert Type on page 101. This is valid for both the internal and external ring signal.

Internal ring signal



External ring signal



Recall signal (Callback reminder)



If a melody is used instead of the ring signal, there is no difference between internal and external calls. The callback signal cannot be a melody, the default *ring* signal number 5, is used instead.

2.8.1.1 Ringing Volume

Use the **Volume** keys to adjust the ring volume. The new volume setting is stored.

2.8.1.2 Mute Ring Signal

To suppress the ring signal for an incoming call, do the following:

1. Press the  key.

The ring signal is switched off for the current call, and the phone is automatically set to *Silent Ringing*.

2. Answer the call.

2.8.1.3 Silent Ringing

If you do not want to be disturbed by the ring signal but still want to be able to answer an incoming call, you can switch off the ring signal. Incoming calls are only indicated by a flashing line lamp and display information.

When the phone is in idle mode, or when ringing:

1. Press the  key to switch off the ring signal.

The indicator is on to indicate silent ringing.

Note: The ring signal will be switched on automatically the next time you lift the handset or press any key.

2.8.2 Tone Characteristics

Different ring tones sound with different cadences, see the list below.

Dial tone



Special dial tone



Ring tone or queue tone



Busy tone



Congestion tone



Vacant number tone

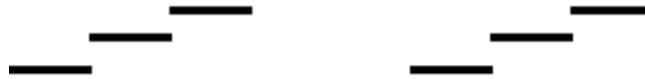

Call waiting tone or verification tone



Intrusion tone



Conference tone*



Connection in progress tone



On hold



* The conference tone can be disabled by the system administrator.

Note: The tones above are the most commonly used tones worldwide. Many markets use a differing tone for one or more situations.





2.9 Handset Mode

The handset mode means that you lift the handset in order to make or answer a call. The features and processes described in this manual are based on the handset mode, but it is possible also to make and answer calls in handsfree mode, that is, without lifting the handset.

2.10 Handsfree Mode



In handsfree mode, you do not lift the handset to start a procedure, and instead of replacing the handset when you end a call, you press the **Clear** softkey or  .

By default, the phone is set to connect calls to the loudspeaker when you answer incoming calls, or when you make calls by pressing a line key. This default setting is known as *the loudspeaker preset mode*. When you dial a number without lifting the handset, the call is also connected to the loudspeaker by default.

Answer a call	Press the line button that indicates an incoming call (the button's indicator is flashing) or press Answer .
Make a call	Dial the number you want to call. When someone answers, the speakerphone is activated. Then you can pick up the handset, or continue to use the speakerphone.
Clear a call	Press the Clear softkey or   .
Switch from handsfree to handset	Lift the handset. .
Switch from handset to handsfree	Press  and replace the handset.
Switch from handsfree to headset	Press  .
Switch from headset to handsfree	Press  .

2.11 Headset Mode

Using a headset allows you to make and receive calls without using the handset.



Plug the headset cable to the connector marked , and the headset is ready to use. If you are using a wireless headset, plug the radio base cable to the connector marked .

- Answer a call** Press  .

- Make a call** Press  and dial the desired number. In headset preset mode, you are not required to press the headset key.

- Switch from headset to handset** Lift the handset.

- Switch from handset to headset** Press  and replace the handset.

- Clear a call** Press the **Clear** softkey or  .

- Change volume** Press  to change the volume. The new volume setting is stored.

By default, the phone is set to connect calls to the loudspeaker. If you are using a headset, you can switch to the headset preset mode to have calls connected to the headset instead.

- Activate Headset Preset** Press  and hold for at least 4 seconds. A short acknowledgement signal is heard.

- Deactivating Headset Preset Mode** Press  and hold for at least 4 seconds. A short acknowledgement signal is heard.

Note: When you lift the handset, the call is always connected to the handset, regardless of the type of preset setting. Activation and deactivation of **Headset Preset** can only be done when the phone is in idle mode.

Note: When headset preset mode is used and when automatic answer is used, it is possible to announce a new call by a special tone in the headset.

2.12 Option Unit

It is possible to install an option unit in the phone. The option unit, which is built into the foot console, provides the phone with a gigabit Ethernet interface and an extra bell and busy signal.

Gigabit Ethernet

The option unit offers a gigabit Ethernet interface module, the purpose of which is to pass on gigabit traffic to the PC connected to the IP terminal. The phone itself does not require the gigabit speed.

Extra bell and busy signal

The option unit offers an interface for auxiliary equipment, such as an external bell or a busy signal indicator. There are three alternatives using this function:

- **Busy Signal.** The busy signal is activated in off-hook mode. Can be used to control a Do-not-disturb lamp at the door.
- **Extra Bell.** The extra bell is activated parallel to the ring signal.
- **Combined Bell/Busy.** A combined busy signal and extra bell. Steady active in off-hook mode, and flashing when the phone rings. Can be used for lamp indication in an office landscape, for example.

2.12.1

Installing an Option Unit

To install the option unit, do the following:

1. Log off the phone and disconnect the power from the phone to avoid electrostatic discharges, ESD.
2. Connect the ribbon cable to the phone, making sure the cable does not get stuck.
3. Attach the option unit at the arrows on the back of the phone. Press until you hear a click sound.

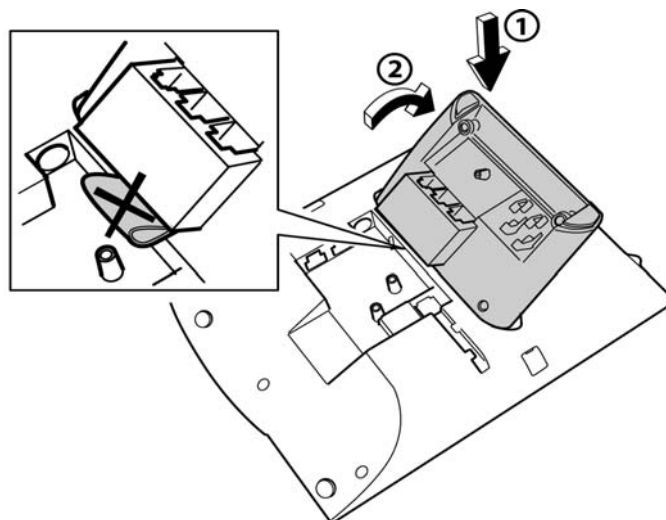

Note: Avoid touching the contacts when you connect the ribbon cable.

4. Connect the cables to the option unit and attach the rubber piece as showed in the figure below.

Apart from the PC and LAN cables, you need connect the auxiliary cable for an extra bell or busy lamp.

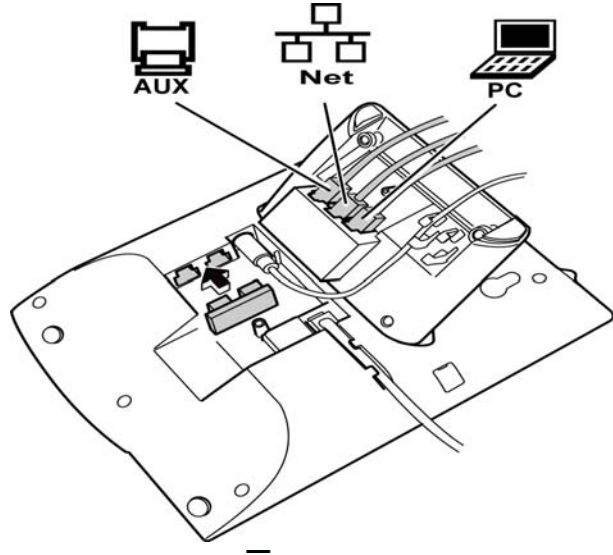

Note: Unless the LAN cable is connected to the port marked **Net** on the option unit, the phone will not work.

5. Attach the ESD covers on the back of the phone to protect the connectors from ESD. For this you need a screwdriver.

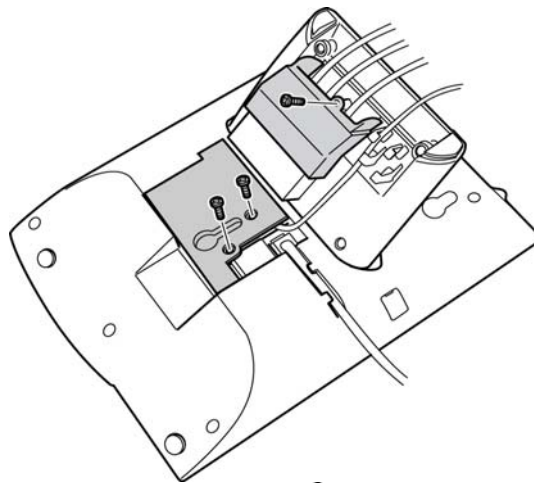

2.12.2

Removing an Option Unit

To remove the option unit, do the following:

1. Disconnect all cables attached to the option unit.
2. Press the unit in the opposite direction to when you installed it.

3. Disconnect the ribbon cable.

2.13 Key Panel Unit and Display Panel Unit

The phone can be equipped with up to three key panel units (KPU) or up to two display panel units (DPU). Each key panel offers 24 additional keys, allowing you to store the most frequently used phone numbers and features. For a description on how to program the keys as shortcuts, see 13.2 Shortcuts on page 97.

DPUs are self-signing, meaning that the name, number, or function that is programmed to a certain key, will be shown in the display next to the key.

For KPUs you need to print and place a card under the plastic designation cover. Use the Design Card Manager (DCM) tool to create and print your own key panel designation cards. The latest version of the DCM tool can be downloaded from www.aastra.com.

For more information, please contact your Aastra Enterprise Certified Sales Partner.

Note: It is not possible to have both KPUs and DPUs installed on the same phone.

2.13.1 Installing a Key Panel Unit or Display Panel Unit

1. Disconnect the power from the phone.
2. Attach the KPU or DPU to the phone.
3. Remove the rubber pieces on the phone.
4. Press down the KPU or DPU until you hear a click sound.

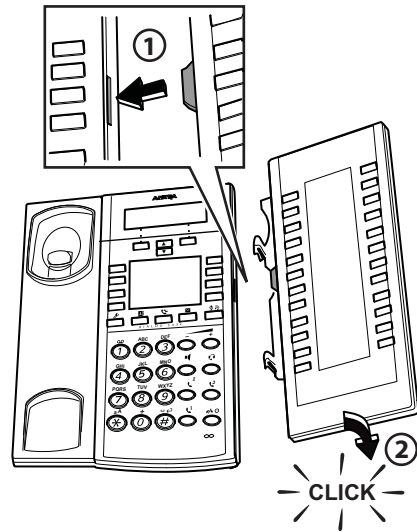

5. Lock the unit.

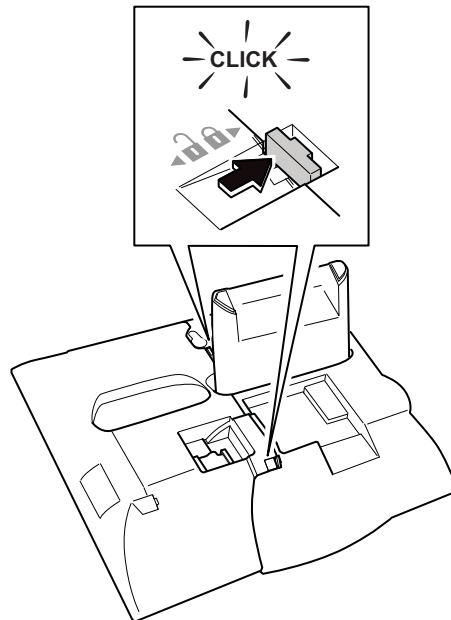

6. Remove the rubber piece from the back of the panel unit.
7. Connect the ribbon cable to the phone. Make sure it fits correctly before pressing it down.

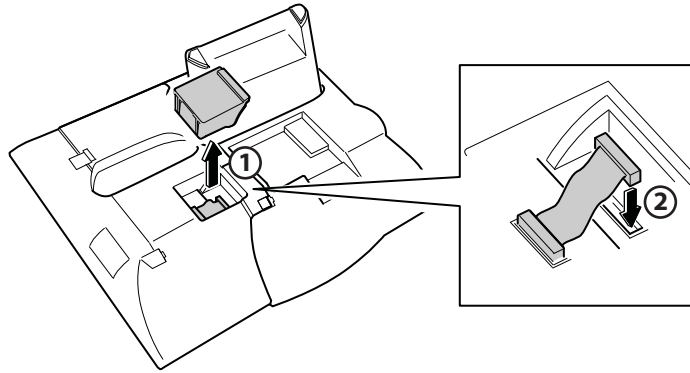

8. Replace the rubber piece.
9. Connect the foot console on the KPU or DPU (the console is enclosed in the box). This is done in the same way as connecting the phone's foot console to the phone.

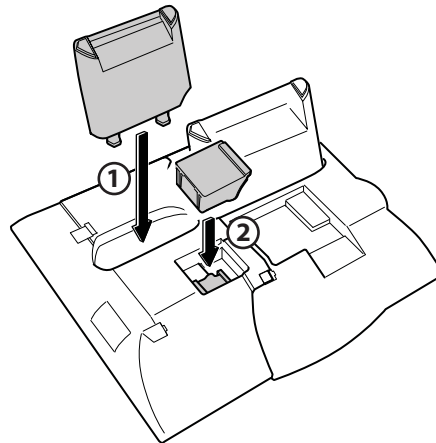

2.13.2

Removing a Key Panel Unit or Display Panel Unit

To remove a KPU or DPU, do the following:

1. Disconnect the power to the phone.
2. Disconnect the ribbon cable from the phone.
3. Unlock the KPU or DPU.
4. Press the unit in the opposite direction to when you installed it.

2.14

Wall Mounting

The phone can be wall mounted. For detailed information on how to do this, please see the installation card which comes with the phone.

3 Starting the Phone

This chapter describes how to start the phone, and how to log on and off. It also describes free seating, and how to check which software version is used.

All system settings for your phone must be set by the system administrator before you can use the phone.

Note: Depending on the settings in your network and telephony system, the startup procedure in your phone may differ from the one described in this manual. Check the display on your phone and read the applicable sections.

3.1 Starting and Logging On

To start the phone, connect the required cables, see figure 2 on page 9. When the phone is connected to the network, the startup procedure starts automatically.

3.1.1 Logging On To the Network

If **LAN access control** is displayed when you start the phone, you need to log on to the network before logging on to the telephony system.

To log on to the network, do the following:

1. Enter the user ID and press **Log on**.
2. Enter the password and press **Log on**.

Note: If you do not know your user ID or your password, contact the system administrator.

3. The phone receives the network settings. If it fails, please try again. If receiving network settings fails one more time, please contact the system administrator.

Note: If the user ID or password is not accepted, the following message is displayed: "Failed Authentication! Check User ID/Password!" Then press **Retry** and make a new logon attempt. Should the logon fail again, please contact the system administrator.

4. The phone receives the phone settings. If it fails, the phone will use the latest settings.

5. If a new software version is available, you will be notified via a display message.

3.1.2 Logging On To the System

When the phone is logged on to the network, there are three possible scenarios:

- The phone is ready to use. This means that the phone logs on automatically to the telephony system.
- You have to log on the phone to the telephony system with an extension number.
- You have to log on the phone to the telephony system with both an extension number and password (or PIN code).

Note: The PIN code can be changed by the user (see 13.8.1 Changing PIN Code on page 106), whereas the password can only be set by the system administrator.

If you are required to log on the phone to the telephony system, you are prompted to enter your extension number, or your password (or PIN code), or both.

To log on to the telephony system, do the following:

1. Enter your extension number and press **Log on**
2. Enter the password (or PIN code), if required, and press **Log on** again.

Note: If the extension number or password is not accepted, the following message is displayed: "Failed User Log on! No calls!" Then make a new logon attempt. Should the logon fail again, please contact the system administrator.

The phone does not work during power failure. After a power failure the phone automatically restarts. When the phone is starting up (rebooting), any PC that is connected to the phone will lose its network connection for about 10 seconds.

3.2 User Type Modes

There are three user type modes:

Free User: You need to log on to the telephony system to be able to use the phone, and you are allowed to log off the phone. This is the most common mode.

Permanent User: The phone is always logged on with a default number. You cannot log on or log off. This mode can be used for phones in, for example, receptions.

Temporary User: The phone is always logged on with a default number, but you can log on with your own extension number and get access to your user profile. This mode can be used in a free seating environment.

Note: Viewing and changing user type modes require administrator rights.

3.2.1 Free User

When log off is allowed, the phone must be logged on (registered) to the telephony system to be used. When the phone is logged off, the display will look like in the figure below. If the emergency call function is enabled, it is possible to make emergency calls. For more information on emergency calls, see 5.3 Emergency Calls (SOS Calls) on page 49.

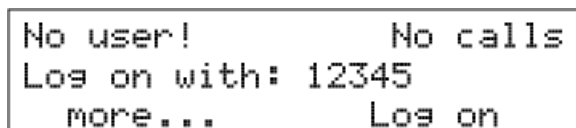

```

No user!           No calls
Log on with: 12345
more...           Log on
  
```

Figure 11: Logon screen when log off is allowed

The last extension number used (by the previous user) remains until changed.

To log on with your own extension number, do the following:

1. Enter your extension number. If it already appears in the display, skip to step 2.
 The displayed number is erased automatically when you start entering new digits. The display shows your entered digits.
2. Press **Log On**.
3. Depending on the configuration, you are logged on automatically, or prompted for login details.
 - If a password (or PIN code) *is not* required, the phone logs on automatically.

- If a password (or PIN code) *is* required, enter your password (or PIN code) and press **Log On** again.
4. When your name and number appears in the display, the phone is ready to use.

Note: The password is obtained from, and can only be changed by, the system administrator. The PIN code (if used) can be changed by the user.

When a user is logged on and the phone is in idle state, the option **Log Off: [logged on user]** appears when you press the soft key **more....** To log off a user, see 3.3 Logging Off the Phone on page 36.

3.2.2 Permanent User

The idle screen mode is displayed, and the phone is ready to use.

Note: It is not possible to log off a phone that has been set to this mode.

3.2.3 Temporary User

The phone is logged on with a default number, but you can log on with your individual number and get your user profile.

To log on with your personal extension number, do the following:

1. Press **more....**, select **Log On Temporary User**, and press **Select**.
2. Enter the extension number for the temporary user, and press **Log On**.
3. If password (or PIN code) is required, enter the password (or PIN code) and press **Log On** again.

Note: All temporary users will be logged off from the phones at some point during night.

3.3 Logging Off the Phone

If logging off the phone is allowed, the option **Log off: [logged on user]** appears when you press **more....**

To log off from the phone, do the following:

1. Press **more...** when the phone is in idle state.
2. Select **Log off: [logged on user]** and press **Select**.

The following message is displayed: "Log off? [logged on user]"

3. Press **Yes** to confirm.



Press **No** to cancel.

- If the logged off user was a temporary user, the preliminary user is logged back on automatically.
- If no user is logged on, only emergency calls are possible.

Note: If the emergency call function is disabled, the message “No calls!” is displayed. For more information on emergency calls, see 5.3 Emergency Calls (SOS Calls) on page 49.

3.4 Automatic Shut Down of the Phone

The system administrator can enable to shut down the phone at a certain time each 24 hours (for power saving reasons). To power up the phone again the user has to do the following:

- Press  .



It takes 1-2 minutes before the phone has started and you get the log on menu.

- If your extension number **does not** have an associated PIN code, the telephone registers to the PBX automatically.
- If your extension number **has** an associated PIN code, you need to enter your PIN code.

The reason why you have to enter your PIN code is that otherwise anybody could power up the telephone and make calls without your knowledge.

3.5 Shutting Down the Phone

To shut down the phone, do the following:

1. Press and hold  .

2. Select **Shut down the Phone** and press **Select**.



A confirmation message is displayed.

3. Press **Yes** to confirm. You are logged off, your shortcuts disappear, and the phone switches off.

- If you press **No**, you are returned to the previous state.

Note: If you have connected a PC to the phone, shutting down the phone will also shut down the PC network connection.

To power up and start the phone again:

- Press  .

It takes 1-2 minutes before the phone has started and you get the log on menu.



- If your extension number **does not** have an associated PIN code, the telephone registers to the PBX automatically.
- If your extension number **has** an associated PIN code, you need to enter your PIN code.

The reason why you have to enter your PIN code is that otherwise anybody could power up the telephone and make calls without your knowledge.

3.6 Restarting the Phone

If your phone does not work properly, you can restart it and restore the default headset and handset volume settings.

To restore the default settings in the phone, do the following.

1. Press and hold  .
2. Select **Restart the Phone**, and press **Select**.
A confirmation message is displayed.
3. Press **Yes** to confirm and restart the phone.

3.7 Updating the Phone Software

When new software is available, you are notified of this via a message in the phone display.

You have 60 seconds to decide if you want to update the software to the latest version.

- Select **No** to skip the update and keep the current software version.
- Select **Yes** to start downloading the software update from the software server. The update process takes approximately 60 seconds to complete, and the progress is displayed on screen.
 - When the update is successful, the phone reboots, and it is then ready to use, or ready for logon, see 3.2 User Type Modes on page 35.

- If the update fails, the phone will use the old software version, and you can start using, or log on when you press **OK**.
- If no key is pressed within 60 second, **Yes** is selected automatically, and the update will be installed.

Note: It is important that you do not disconnect the phone power supply while the new software is being downloaded and saved. If a power failure occurs, the software must be downloaded again.

3.8 Free Seating

Free seating is a feature that enables you to log on to your IP extension from any IP phone that allows temporary or free users by using your own extension number. This means that the IP phones automatically work as free seating phones within the network.

Note: Using the Free Seating feature by entering * 11 * *authorization code* * *extension number* # is not applicable.

3.9

Software Version

To view which software version is installed currently, do the following:

1. Press  .
2. Select **Help** and press **Select**.
3. Select **About Aastra 7434ip** and press **Select**.
The software version is displayed.
4. Press **Back** to return to previous menu.

4 Incoming Calls

This chapter describes how to answer and reject incoming calls, how to pick up calls on other extensions, and how to check missed calls.

4.1 Receiving Calls

An incoming call is indicated by a ring signal, and a flashing indicator associated with the line on which the call is presented. The phone display shows the number of the caller (or the name, if the calling number is one of your contacts).



Note: If the feature parallel ringing is activated, the call will ring on more than one phone, see 4.6 Parallel Ringing on page 43.

4.1.1 Answering a Call

You can answer incoming calls in handset mode or handsfree mode:

- *Handset:* Lift the handset. The call is received on ¹.
- *Handsfree:* Press the flashing line button without lifting the handset. (You can then switch to the handset by lifting the handset.)

4.1.2 Rejecting a Call

If you are busy and prefer not to answer a specific incoming call, you can reject it by pressing either   or **Reject**. The caller will then hear a busy tone, and the call is disconnected.

4.2 Picking Up Calls

You can answer calls to your extension from another phone, as well as answer calls to another extension from your phone. This feature is known as *picking up* calls.

To pick up a call, do the following:

1. Lift the handset and call the ringing extension.
2. Call the ringing extension, or press the extension shortcut, if any.
3. When you get a busy tone, press 8.

Note: France and New Zealand, press 4; Sweden, press 6.

Note: Some phones can be protected against call pick-up.

4.3 Missed Calls

If you have new missed calls in the call list, the call list key  indicator flashes.

To check your missed calls, do the following:

1. Press the  key to enter the call list.

The call list indicator is switched off.

2. Step through the call list by pressing the navigation keys .

3. Press the  key to exit the call list.

4.4 Automatic Answer

When the automatic answer feature is active, incoming calls are answered automatically in handsfree mode. This means that you get speech connection without having to perform any action. The feature is set by the system administrator.

There are two optional settings for the automatic answer feature:

- **With delay:** One ring signal is heard before the call is answered.
- **Without delay:** The call is answered immediately, no ring signal is heard.

Changing the settings for automatic answer requires administrator rights, but you can view the current settings.

To view the automatic answer settings, do the following:

1. Press .
2. Select **Auto answer** and press **Select**.

The current setting is displayed.

4.5 Answering a Second Incoming Call

You have three access lines (☎¹, ☎², ☎³) for incoming and outgoing calls. All lines have the same extension number. This feature is called *triple access line*.

To answer a second incoming call, do the following:

1. You have an ongoing call on the ☎¹ key, and the ☎² key flashes to indicate a new incoming call.
2. Press ☎² key to answer.

The first call is put on hold.

Note: To answer a second incoming call, you have to activate *Free on busy*, see below. A call waiting call can be answered although *free on busy* is not activated.

4.5.1 Activating Free on Busy

To activate Free on busy, do the following:

1. Press **Presence**.
2. Select **Free on busy: OFF**, and press **Select**.
3. Select **ON put call through**, and press **Set**.

A confirmation question is displayed.

4. Press **Yes** to confirm.

Note: If you have ongoing calls on line 1 and on line 2 and if there is a new call received on line 3, you cannot transfer any of the calls to a fourth part.

4.6 Parallel Ringing

Parallel ringing makes it possible for an incoming call to ring several phones simultaneously and for the call to be answered on any of these phones. The main advantage of this feature is that you do not risk losing any calls.

The parallel ringing feature requires all phones involved to be defined in a parallel ringing list, which is set up by the system administrator. Only calls to a predefined main extension will be distributed to the phones on the parallel ringing list. Incoming calls to other extensions will ring only on their respective extensions.

To answer a parallel ringing call, lift the handset on any of the ringing extensions.

4.6.1 Disabling Parallel Ringing

You can disable parallel ringing temporarily by activating Follow-me.

4.6.1.1 Disabling On Your Phone

To disable parallel ringing on one phone in the parallel ringing list, activate Follow-me to *the main extension*. For more information on Follow-me, see 7 Call Forwarding on page 58.

4.6.1.2 Disabling On All Phones

To disable parallel ringing on all phones in the list, activate Follow-me to *all extensions except the main extension*. For more information, see 7.1.1 Ordering Follow-me From Own Phone on page 58.

4.6.2 Restoring Parallel Ringing

To restore parallel ringing, deactivate Follow-me.

Restoring On Your Phone

To restore parallel ringing on one phone in the list, deactivate Follow-me from that phone, see 7.1.2 Canceling Follow-me From Your Own Phone on page 58.

Restoring On All Phones

To restore parallel ringing on all phones in the list, deactivate Follow-me from these phones, see 7.1.4 Canceling Follow-me from Another Phone on page 59.

5 Outgoing Calls

This chapter describes how to make outgoing calls, and lists the options available to you when you receive a busy tone or no answer.

5.1 Making Calls

You can call both internal and external numbers from your phone. To dial an external number, you must first enter the *external access code*.

Note: The external access code is one or more digits used in your office to get a line for external calls, for example 0 or 00.

To make a call, do the following:

- 1) Lift the handset and wait for a dial tone.
- 2) Dial the number.
 - For *internal* calls, dial the extension.
 - For *external* calls, enter the external access code and dial the external number.

It is possible to use short numbers for numbers that you call often, 5.5 Speed Dialing on page 51.

5.2 When You Receive a Busy Tone or No Answer

If you call an internal number and you receive a busy tone or get no answer, or if all external lines are busy, you can either try again later, or order automatic callback, call waiting, or intrusion.

5.2.1 Callback

When you order callback for a busy extension, you will be called back as soon as the extension or line becomes free. If you order callback when there is no answer, you will be called back when the extension has been used the next time.

Note: When you return to the office, you can tell the system that you are present by lifting the handset and immediately replacing it.

You can order automatic callback in the following cases:

- If the internal number you have called is busy or does not answer. You can have several callbacks activated at the same time.
- If all external lines are busy. You can have only one callback activated on a busy external line.

Note: While waiting for a callback, you can make and receive calls.

5.2.1.1

Ordering Callback

To order callback, do the following:

- 1) Press **Callback**.

It takes a few seconds before the procedure is executed. A confirmation message is displayed.

- 2) Replace the handset to finish the procedure.

You are called back (callback reminder) when the ongoing call is finished or the next time a new call is finished.

5.2.1.2

Ordering Callback When All External Lines Are Busy

If all external lines are busy (after dialing the digit or digits to get an external line), do the following:

1. Press **Callback**.

Wait for dial tone.

2. Dial the external number (or part of the number, or no number) and press **#**.

- You can have a callback on the external line, that is, you will be notified when the external line is free without specifying the external number to call.
- You can enter a number that will be dialed automatically when you answer the callback call.
- You can enter part of the number, and dial the remaining digits when you answer the callback call.

3. Replace the handset.

When the external line becomes free, you will be called back (callback reminder).

5.2.1.3

Answering Callback

As soon as an internal number, or an external line, becomes free, you will be called back.

To answer a callback call, do the following:

1. Lift the handset. You will hear the ring tone.

You have to answer within 8 seconds, otherwise the callback is cancelled.

Note: If you have ordered callback for an external line, you may be prompted to enter any remaining digits.

2. The system calls the number you have requested for callback.

5.2.1.4

Canceling All Callbacks

To cancel all callbacks, do the following:

- 1) Lift the handset and wait for a dial tone.
- 2) Press **more....**
- 3) Select **Cancel all Callbacks**, and press **Select**.

A confirmation message is displayed.

- 4) Press **Yes** to confirm, or **No** to cancel.
- 5) Replace the handset.

Note: This procedure cancels callbacks to internal numbers and busy external lines.

5.2.1.5

Canceling a Single Callback

To cancel a single callback, do the following:

- 1) Lift the handset and wait for a dial tone.
- 2) Dial # 37 * *internal number* #.
- 3) Replace the handset.

Note: To cancel a single callback on an external line, enter the digit or digits required for a line, rather than the internal number.

5.2.2

Call Waiting

If you urgently wish to contact a busy extension, you can send a notification using a *Call Waiting* signal. Call Waiting is indicated either by a tone (if the busy extension is an analog extension), or as a second call (if the busy extension is a digital system phone or an IP phone).

Note: If the called extension does not accept Call Waiting signals, you will continue to hear a busy tone. If the busy extension ignores

the Call Waiting function key, you can order automatic Callback, see 5.2.1 Callback on page 45.

5.2.2.1 Activating Call Waiting

To send a call waiting signal to the busy number, do the following:





1. Press **more....**
2. Select **CallWaiting**, and press **Select**.
3. Keep handset off hook. If the called party answers your call waiting request, the call will be established. If the called party does not want to answer your call, you will continue to hear the ring tone until you go on hook.

5.2.2.2 Answering a Call Waiting Call

When you get a call waiting indication (call waiting tone or ring signal and  is flashing), there are the following possibilities:

1. Park the ongoing call.
2. End the ongoing call.
3. Reject the call waiting request.

If you want to park the ongoing call, do the following to answer the call waiting call:

1. When the ongoing call is on  and the  flashes to indicate the call waiting call.
2. Press the  key. The call on  is automatically parked.
3. To retrieve the other call press the line key again.



If you want to end the ongoing call and then answer the call waiting call:

1. End the ongoing call.
2. Wait for ring signal.
3. Lift the handset to answer the waiting call.

If you want to reject the call waiting request:

1. Press **Reject**.
2. Continue with the ongoing call.

5.2.2.3 Canceling Call Waiting

To cancel Call Waiting, replace the handset, or press  .

5.2.3 Intrusion

You can intrude on an ongoing call on a busy extension. If intrusion is not allowed for the called extension, you will continue to hear a busy tone. Before the intrusion is executed, an intrusion tone is sent to the parties in the ongoing call. As long as the three parties are connected, you will hear an intrusion tone.

Note: Intrusion might be blocked for use on your extension (this is programmed by the system administrator). If Intrusion is not allowed, you will continue to hear a busy tone.

The warning tone can be disabled by categorization, both before and during the intrusion.

To intrude on an ongoing call at a busy extension, do the following:

1. Press **more...**
2. Select **Intrude**, and press **Select**.

5.2.4 Bypass

If you need to get through to a certain extension currently being forwarded by follow-me, you can bypass the extension.

If this feature is allowed from your extension, you can bypass an activated Diversion, an activated Follow-me or an activated Absence Information on a specific extension.

To request a bypass ordered by an extension, do the following:

1. Lift the handset and wait for a dial tone.
2. Dial *60*, enter the extension number and press #.
3. Wait for answer.

Note: U.S. and Canada: Dial *1* extension number #.

5.3 Emergency Calls (SOS Calls)

The emergency call feature allows you to make emergency calls even when the phone is not logged on to the exchange. If the feature is disabled, emergency calls are not allowed when the phone is logged off the exchange.

Note: The emergency call feature is enabled by the network administrator.

This section describes how to make emergency calls in different phone modes.

5.3.1 The Phone Is Logged On

- Dial the emergency number (SOS number).
Wait for answer.

5.3.2 The Phone Is Logged Off, With Emergency Call Feature Enabled

When the emergency call feature is enabled, you can make emergency calls even when the phone is logged off.

When the emergency call feature is enabled the display looks like this:

```

No user!    112 Calls only!
Log on with: 12345
more...           Log on
  
```

- Dial the emergency number (SOS number).
Wait for answer.

When the emergency call has been terminated, the emergency centre can call back to your phone even though it is logged off.

5.3.3 The Phone Is Logged Off, With Emergency Call Feature Disabled

When the emergency call feature is disabled, the SOS text does not appear in the display. This means that you cannot make emergency calls unless you log on the phone.

When the emergency call feature is disabled the display looks like this:

```

No user!           No calls
Log on with: 12345
more...           Log on
  
```

1. Log on with your extension number.
2. Dial the emergency number (SOS number).
Wait for answer.

5.4 Redial Calls

When you initiate an external call, the system automatically stores all the dialed digits, regardless of whether the call was successful or not. It is possible to redial the last dialed external number, or to choose a number from the call list.

5.4.1 Redial Last External Number

To redial the last dialed external number, do the following:



- 1) Lift the handset and wait for a dial tone.
- 2) Press *** (while in idle state or with dial tone).

The last dialed external number is automatically redialed.

Note: Finland and Sweden: Press **0.

5.4.2 Redial a Call from the Call List

To make a call using the call list, do the following:

- 1) Press the  key to open the call list.
- 2) Scroll the call list with the navigation keys .
- 3) Press **more...** and select **Show missed calls** or **Show all calls**.
- 4) Select the desired number (or contact) and press **Call**.
- 5) Lift the handset.

5.5 Speed Dialing

Frequently used phone numbers are stored as speed dialing numbers in the exchange.

By using common speed dialing numbers, you can make calls simply by pressing a few keys. The common speed dialing numbers consist of 1–5 digits and are stored in the telephony system (by the system administrator).

5.5.1 Speed Dialing Numbers

To speed dial a number, do the following:

- 1) Lift the handset and wait for a dial tone.
- 2) Dial the speed dialing number.

5.5.2 Speed Dialing Contacts

To speed dial a contact, do the following:

1. Press and hold the key (2-9) that holds the first character in the name of the contact you want to call.

The available names for that key are shown in the display. If, for example, you press and hold down the numeric key **2** for 2 seconds, the phone book entries starting with the letter **A** are displayed.

2. Find the contact you want to call.
3. Press **Call** and lift the handset.

5.6 Dial by Contacts

To dial a contact, do the following:

- 1) Press  to open your contacts.
- 2) Find the contact you want to call, or press and hold the key (2-9) that holds the first character in the name of the contact you want to call.

The available names for that key are shown in the display. If, for example, you press and hold the numeric key 2 for 2 seconds, the phone book entries starting with letter A are displayed.

- 3) Select the contact you want to call, lift the handset, and press **Call**.

5.7 Dial by Shortcuts

Both features and phone numbers can be programmed from a shortcut key. See 13.2 Shortcuts on page 97 for information on how to program a shortcut key.

To dial by a shortcut key, do the following:

1. Press the shortcut key.
2. Lift the handset.

5.8 Number Presentation Restriction

If you do not want your name and number to be displayed to the person you are calling, you can order number presentation restriction.

When you have ordered number presentation restriction, instead of your name and number, the text “Anonymous” will appear in the display of the phone you are calling. The number presentation restriction is valid only for the current call, which means that the procedure has to be repeated the next time you want to use it.

Note: This feature can be blocked for use on your extension. Contact the system administrator for more information.

5.8.1 Ordering Number Presentation Restriction

To order number presentation restriction from your phone, do the following:

- 1) Lift the handset.
- 2) Dial * 42 #.
Wait for a dial tone.
- 3) Dial the desired number.

5.9 Individual External Line

To call an individual external line, do the following:

1. Lift the handset.
2. Dial * 0 *, *individual external line number* #.
3. Dial the digit or digits to get an external line and the external number.

6 During Calls

This chapter describes a number of features that you can activate during an ongoing call. Placing a call on hold, making a transfer, and starting a conference are a few examples.

6.1 On Hold

You can put an ongoing call on hold temporarily by pressing **Hold**, or by pressing the line key used for the ongoing call.

6.1.1 Retrieving a Call On Hold

To retrieve a call that has been put on hold, do the following:

- Press the line key where you have a call on hold.

OR

- Press **more...**, select **Retrieve** [*call on hold*], and then press **Select**.

6.2 Inquiry

Inquiry means placing an ongoing call on hold, and then call a new party.

6.2.1 Making an Inquiry

To make an inquiry to a third party during an ongoing call, do the following:

- 1) Press **Hold** (or any line key).
- 2) Enter the number to the third party (on a new line).

When the third party answers, you can switch between the calls, transfer the call, create a conference or end the active call.

6.2.2 Switching Between Calls

During inquiry you can switch between the ongoing call and the call on hold.



To switch between calls, do the following:

- 1) Press the line key that holds a call.

The call that was put on hold on that key is connected, and the other call is put on hold instead.

- 2) Replace the handset or press   to terminate the connected call.

OR

1. Press **more...**
2. Select **Retrieve** [*call on hold*] and press **Select**.
3. Replace the handset or press   to terminate the connected call.

6.3 Transfer

You can transfer a call to an internal number, an external number, your mobile phone, or to the operator. You can transfer the call before or after the third party answers.

Note: If you have put more than one call on hold, the last call that was put on hold will be transferred. If the dialed extension is busy, or if transfer is not allowed, your phone will ring again.

6.3.1 Transfer to Another Number

To transfer a call to another number, do the following:

- 1) Press **Hold** or the line key used for the ongoing call.
- 2) Dial the desired internal or external number.
- 3) Press **more...**, select **Transfer to** [*call on hold*] and press **Select** before or after answer.

The call is transferred.

6.3.2 Transfer to Your Mobile Phone

To transfer an ongoing call to your mobile phone, do the following:

1. Press **more....**
2. Select **Transfer to My mobile**, and press **Select**.

Transfer will be done before answer.

Note: You need to program your mobile phone number to be able to transfer a call to this number. See 13.1.5 My Mobile Phone on page 97) for instructions.

6.3.3 Transfer to Operator

To transfer an ongoing call to the operator, do the following:

1. Press **more....**
2. Select **Transfer to Operator**, and press **Select**.

Transfer will be done before answer.

6.4 Conference

You can include up to 7 participants in a conference. Only the conference leader (that is, the person initiating the conference) can admit participants.

If you have an ongoing conversation and want to establish a phone conference, you will become the conference leader. If the conference leader leaves the conference, the first added participant will become the new conference leader, and the conference continues with the other included parties. When there are only two parties left, the conversation is changed back to a normal two party connection.

To establish a conference, do the following:

1. Press **Hold**, or a line key.
2. Call the third party.
Wait for answer.
3. Press **more....**, scroll to **Conference all**, and press **Select**.
4. Repeat the procedure to add more conference members.

A conference tone is heard throughout the conference.

Note: The conference tone might be disabled for your system.

To leave the conference, replace the handset or press  .

6.5 Suffix Dialing (DTMF)

When communicating with and controlling a voice mail system, or when retrieving information about your bank account through your phone, you need to use Dual Tone Multi-Frequency (DTMF) signals, also known as suffix dialing.

The suffix dialing function is always active for all calls in speech.

All digits entered are converted automatically by the exchange into DTMF signals, which then are transmitted along the connected lines.

7 Call Forwarding

Call forwarding is useful when, for example, you are working temporarily from another room and want your calls to follow you to that room, or if you want your incoming calls to be forwarded to one of your contacts.

7.1 Internal Follow-me

Internal follow-me allows you to redirect incoming calls to another extension within the network. You can use both predefined and new phone numbers.

When follow-me is activated, this is indicated in the display, and the Follow-me key is lit. Your phone can still be used for outgoing calls and you will hear a special dial tone when you lift the handset.

7.1.1 Ordering Follow-me From Own Phone

To order internal Follow-me, do the following:

1. Press **Availability**, select **Follow-me**.
2. Enter the extension number of the answering position. Press **Done**

You can also select the number to the answering position from your Contacts. Press **more...** and **Set from Contacts**. This option appears only if you have contacts.

FollowMeTo and the answering position is shown in the display. The follow-me key lamp is turned on.

When lifting the handset a special dial tone is heard.

Note: Follow-me cannot be activated by pressing the Follow-me key.

7.1.2 Canceling Follow-me From Your Own Phone

To cancel Follow-me from your phone, do the following:

1. Press the Follow-me key.

OR

1. Press **more....**
2. Select **Disable all diversions**, and press **Select**.

Note: Using this procedure will also disable any selected absence reasons.

OR

1. Press **Availability**, select **Follow-me**.
2. Press **more...** and select **Deactivate Follow-me**

7.1.3 Ordering Follow-me From Another Phone

You can order follow-me of your own extension number from another telephone.

The first step is to allow that follow-me is permitted to be done from another telephone. Do the following from your own telephone:

1. Press **Availability**, select **Follow-me**.
2. Enter your own extension number.

FollowMeTo and the answering position is shown in the display. The follow-me key lamp is turned on.

To order follow me from another telephone:

1. Lift the handset and wait for a dial tone.
2. Dial **21* own extension number * the extension number of the new answering position #.*

Wait for a special dial tone.

3. Replace the handset.

7.1.4 Canceling Follow-me from Another Phone

To cancel Follow-me from another phone, do the following:

1. Lift the handset and wait for a dial tone.
2. Dial *#21* own extension number*, and press #.

Wait for dial tone.

3. Replace the handset.

7.1.5 Ordering Follow-me Remotely

With this feature you can order follow-me of any extension number from any telephone.

The prerequisite is that all the involved telephones have the right service profile.

To order remote programming of follow-me, do the following:

1. Lift the handset and wait for dial tone.
2. Dial **21*extension number to divert * extension number of the new answering position#*.
3. Wait for special dial tone.
4. Replace the handset.

7.1.6 Canceling Follow-me Remotely

To cancel remote programming of follow-me from another telephone than the telephone with the diverted number:

1. Lift the handset and wait for dial tone.
2. Dial *#21*diverted extension number#*.
3. Replace the handset.

The indication of the active follow-me on the telephone with the diverted number disappears, if there is no additional diversion remaining.

7.2 External Follow-Me

If external follow-me is allowed, you can have all calls to your extension diverted to an external number of your choice.

When follow-me is activated, this is indicated in the display. Your phone can still be used for outgoing calls and you will hear a special dial tone when you lift the handset.

7.2.1 Ordering External Follow-me from Your Phone

To order external Follow-me, do the following:

- 1) Press **Availability**, select **External Follow-me**.
- 2) Enter the digit or digits to get an external line and the external number.

External Follow-me is shown on the display. The Follow-me key lamp is switched on.

Note: Follow-me cannot be activated by pressing the Follow-me key.

7.2.2 Canceling External Follow-me from Your Phone

To cancel external Follow-me, do the following:

1. Press the Follow-me key.

OR

1. Press **more....**
2. Select **Disable all diversions**, and press **Select**.

Note: Using this procedure will also disable any selected absence reasons.

OR

1. Press **Availability**, select **Follow-me**.
2. Press **more...** and select **Deactivate External Follow-me**

7.2.3 Ordering External Follow-Me Remotely

With this feature you can order external follow-me of any extension number from any telephone.

The prerequisite is that all the involved telephones have the right service profile.

To order programming of external follow-me for another extension, do the following:

1. Lift the handset and wait for a dial tone.
2. Dial **22* extension number to divert # route access code and the external number #*
3. Replace the handset.

The Follow-me key is lit and the and the display shows the external follow-me text, on the telephone that has been diverted.

7.2.4 Canceling External Follow-me Remotely

To cancel the remote programming of external follow-me for another extension, do the following:

1. Lift the handset and wait for a dial tone.
2. Dial *#22* diverted extension number #*.
3. Replace the handset.

7.3 Personal Number and Profiles

With the personal numbers and profiles feature a number of answering positions can be defined in a profile. When somebody calls your normal office phone number the call will be announced on the telephones defined in your active profile.

A search profile can be designed to fit the situation (in the office, traveling, at home, and so on). Both internal or external phone numbers can be used in a profile. Maximum five profiles can be defined.

Your search profile is programmed or modified by your system administrator. You can also manage your profiles yourself by using the CMG Office Web application, if available. Contact your system administrator for more information

When the feature is activated, incoming calls are transferred to your selected phones or backup services in the order that you choose. If an answering position in the profile is busy, the call can be transferred to another predefined position in the profile (VoiceMail or a colleague).

7.3.1 Activating Or Changing Profiles From Your Phone

To select a profile from your phone, do the following:

1. Press **Availability**, select **My Profile**.
2. Enter the search profile digit (1-5).
3. The profile number (or name) is shown in the display.

7.3.2 Canceling a Profile From Your Phone

To cancel a profile from your phone, do the following:

1. Press **Availability**, select **My Profile**.
2. Press **more...** and select **Deactivate profile**
3. The profile number (or name) disappears from the display.

7.3.3 Activating Or Changing Profiles From an External Phone

The external phone must be of push button type provided with a pound key (#) and a star key (*), or a mobile phone adapted for dial tone pulses (DTMF).

1. Call the DISA feature at your office.
Wait for dial tone.

2. Dial **75* authorization code #*.
3. Dial *own extension number #*.
Wait for dial tone.
4. Dial **10* own extension number #*, enter the search profile digit (1-5) and press #.
5. Replace the handset.

Note: If VoiceMail is included in the activated profile, make sure to always update your greeting with Absence Information.

7.3.4 Canceling a Profile From an External Phone

The external phone must be of push button type provided with a pound key (#) and a star key (*), or a mobile phone adapted for dial tone pulses (DTMF). To cancel, do the following:

1. Call the DISA feature at your office.
Wait for dial tone.
2. Dial **75* authorization code # own extension number #*.
Wait for dial tone.
3. Dial *#10* own extension number #*.
4. Replace the handset.

7.3.5 Designing and Ordering Your Search Profiles

When you are creating your search profiles, you should consider the following:

- Avoid ring times longer than 45 seconds for your profiles.
Callers typically hang up after 3-6 ring signals.
- Consider the time you need to react and answer on each answering position in your profile. You might need up to 15 seconds to react and answer a call on a desk or cordless phone, and 20-25 seconds for a mobile phone.
- There must be an answering position at the end of every profile (VoiceMail or operator/secretary). If not, calls may be unanswered.
- Consider how you want incoming calls to be handled while you are busy on a phone. Available options are:
 - Activate Free on Busy (if available)
 - Follow-me to VoiceMail

- Follow-me to the operator
- If an answering machine, a fax or other answering device is used as an early answering position, it might interfere with the searching. Disconnect the answering device, or design the ring times so they do not affect the searching.
- Make sure you use as few answering positions as possible for each profile. Profile examples:
 - In office
 - At home
 - Traveling
 - Absent/not reachable

Example of how to fill in your settings form for search profiles:

Table 3 Profile 1 - In office

Search order	Type of phone or answering position Examples: Desk, Cordless, Mobile, External, Voice Mail, Operator, and so on	Phone number	Ring time (seconds)
1	Desk	12345	10
2	Cordless	52341	15
3	Voice Mail	55555	

Table 4 Profile 2 - At home

Search order	Type of phone or answering position Examples: Desk, Cordless, Mobile, External, Voice Mail, Operator, and so on	Phone number	Ring time (seconds)
1	External	00082222222	20
2	Mobile	07066666666	25
3	Voice Mail	08222555555	

8 Contacts

This chapter describes how to manage contacts.

When pressing the Contacts key , you can select your local Contacts or the Corporate directory.

In this section you can also get information on how to copy your Microsoft® Outlook® contacts to your personal contacts,

The phone can hold up to 1,000 contacts.

8.1 Calling a Contact

There are two ways to open the contact list to make a call to a contact:

- Open the contact list and scroll to the desired contact.
- Enter the contact list at the desired letter.

To scroll the contact list for the desired contact, do the following:

- 1) Press .

The contact list appears.

- 2) Scroll the list with the navigation keys, or find the desired contact by tapping the numeric key with the initial letter of the contact name.
- 3) Select the desired contact and press **Call** to initiate a call.

To enter the contact list at a certain letter, do the following:

- 1) Press and hold one of the numeric keys **2 - 9**.

The contact list opens at the first name of the pressed letter. For example, if you press and hold the numeric key **5** for a few seconds, all contacts starting with **J** are displayed.

Scroll the list with the navigation keys.

- 2) Select the desired contact, and press **Call** to initiate the call.

8.2 Adding a Contact

There are three ways to add a contact:

- Manually add a new contact.
- Add a number from the call list.
- Add contact from the web interface, see 14.3.1 Contacts Folder on page 112.

8.2.1 Adding a New Contact

To add a new contact, do the following:

1. Press .
2. Press **more...**
3. Select **Add new manual input**, and press **Select**.
4. Enter a number, and press **OK**.

If you make a typing mistake, press the volume down key or **more...** and select **Erase** or **Erase all**.

5. The new contact is added, with the number saved also as name.

Note: If you would like to edit the name, number or ring signal for this contact, press **more...**, and select what to edit. See 8.3 Editing a Contact on page 67 for more information.

6. Press **Done** to save the new contact.

8.2.2 Adding a Contact From the Call List

To add a contact from the call list, do the following:

1. Press .
2. Press **more...**
3. Select **Add new from Call List**, and press **Select**.
4. Select the number to add as a contact, and press **Add**.
5. **Note:** If you would like to edit the name, number or ring signal for this contact, press **more...**, and select what to edit. See 8.3 Editing a Contact on page 67 for more information.
6. Press **Done** to save the number as one of your contacts.

Note: External number must be preceded with the external access code. The digits can also be stored by adding the country code number after a plus sign, for example +46 8 719 0000.

8.3 Editing a Contact

This section describes how to edit a contact from the phone. It is also possible to edit a contact via the web interface, see 14.3.1 Contacts Folder on page 112.

To edit a contact name or number, do the following:

1. Press .
2. Select a contact and press **more....**
3. Select **Edit [selected contact]**, and press **Select**.

You can change the contact name, number, or ring melody.

4. Press **more....**, select what to edit, and press **Select**.

To edit the contact name, continue to 8.3.1 Editing the Name on page 67.

To edit the contact number, continue to 8.3.2 Editing the Number on page 68.

To edit the contact ring signal, continue to 8.3.3 Editing the Ring Signal on page 68.

When entering a name by multi-tapping, the most common letters are written above each key on the phone. To get the letter A press 2 once, for B press 2 twice, to get C press 2 three times and so on.

Press * to switch between upper and lower case.

By default, the first character you enter is written in upper case, and the rest of the word is written in lower case. Every new word starts with an upper case character (that is, after an entered space).

You can select a different character set from **Settings**, see 13 Settings on page 96.

8.3.1 Editing the Name

To edit a contact name, do the following:

1. Select **Edit Name**, and press **Select**.
2. Press **more....**

3. Select **Erase** to erase one letter at the time.
OR
Erase all to erase the whole entry.
4. Make the changes, and press **OK**.
If you wish to edit the number or ring signal, press **more....**
5. Press **Done** to save and return to the contact list.

8.3.2 Editing the Number

To edit a contact number, do the following:

1. Select **Edit Number**, and press **Select**.
2. Press **more....**
3. Select **Erase** to erase one number at the time.
OR
Erase all to erase the whole entry.
4. Enter the correct phone number, and press **OK**.
5. Press **Done** to apply the change, and to return to the contact list.

8.3.3 Editing the Ring Signal

To edit a ring signal, do the following:

1. Select **Edit Ring**, and press **Select**.
2. Scroll to see the list of available ring signals.
To listen to a signal before selecting it, press **more...** and then **Play**.
3. Select the desired ring signal and press **Set**.
4. A confirmation message is displayed.
5. Press **Yes** to confirm or **No** to cancel.
6. Press **Done** to return to the contact list.

8.4 Deleting a Contact

It is possible to delete a selected contact, or all contacts at once.

8.4.1 Deleting One Contact

To delete a contact, do the following:

1. Press .
2. Select a contact and press **more....**
3. Select **Delete [contact]** and press **Select**.
A confirmation message is displayed.
4. Press **Yes** to confirm or **No** to cancel.

8.4.2 Deleting All Contacts

To delete all contacts in the contact list at the same time, do the following:

1. Press .
2. Press **more....**
3. Select **Delete all contacts** and press **Select**.
4. Press **Yes** to confirm or **No** to cancel.

8.5 Corporate Directory

The corporate directory, which holds all contacts in your organization, resides on a corporate directory server.

When you search a contact in the corporate directory, a request is sent to the corporate directory server, which returns a list of names that matches the search. You can then choose to view the contact details, to call the contact, or to add it to your personal contacts.

8.5.1 Searching a Contact In the Corporate Directory

To call a contact in the corporate directory, do the following:

1. Press  and select **Corporate Directory**.
2. Enter the name or number you wish to search and press **Search**.

To search a name, enter the *last name* first, then the *first name*, adding a space between the last and first names.

Example: To search for all persons with a last name starting with B and a first name starting with S, enter “*B S*”.

To search only a first name, add a space before the name.

Example: To search for all contacts with the first name of Susan, enter a space followed by the name, that is, “*Susan*”. All contacts called *Susan* are displayed, as are all contacts called *Susanne*.

3. When the search result is displayed, you can select a contact to **Call**, or press **more...** to **Add to Contacts**, or view the **Details** of the selected contact.

Note: If the search results in one contact only, that contact’s details are displayed.

For more information about adding a contact, see below.

4. To make a new search, press **more...**, select **New Search** and press **Select**.

Note: The syntax to enter the name when searching, can differ dependant on the type of directory server. The syntax above is valid for the Aastra CMG directory.

8.5.2

Adding a Contact From the Corporate Directory

To add a contact from the corporate directory, do the following:

1. Press  and select **Corporate Directory**.
2. Enter the name or number you wish to search and press **Search**.

The search result is displayed.

3. Select the contact you wish to add to your Contacts and press **more...** and **Add to Contacts**.

The name and number appear in their respective fields.

4. To modify the name, number or the ring signal, press **more...** and **Edit number**, **Edit Name** or **Edit Ring**.

For instructions on how to change the ring signal, see 8.3.3 Editing the Ring Signal on page 68.

5. Press **Done** when you are done editing the contact fields. The new contact is saved.
6. Press **OK** to confirm

8.6 Microsoft® Outlook® Contacts

You can copy your Microsoft® Outlook® Contacts to the contact list in your phone. These numbers will be available in your phone in the same way as they are stored in Microsoft® Outlook® Contacts. My Dialog Contacts can store up to 1,000 contact entries.

Before you can copy Microsoft® Outlook® Contacts, you need to install the My Dialog 4000 Contacts application on your PC. Contact the system administrator to obtain a link to the installation page.

Note: Store all phone numbers in Microsoft Outlook with area and country code, including the international + sign.

8.6.1 Installing My Dialog 4000 Contacts

To install the My Dialog 4000 Contacts on your PC, do the following:

1. Make sure you have the necessary information at hand when you start the installation.
2. Click the link **Install My Dialog 4000 Contacts now**.
3. Follow the instructions on screen to complete the installation.

When the installation is complete, the My Dialog 4000 Contacts icon appears on the desktop.

8.6.2 Adding Microsoft® Outlook® Contacts

To add My Dialog 4000 Contacts to your contact list, do the following:

1. Start the **My Dialog 4000 Contacts** application by clicking the icon.
2. Enter your phone number, phone password, and the IP address to the phone.

Note: You find the phone IP address by clicking , and selecting **Help, About Aastra 7434ip, Phone IP Address**.

3. Click **OK**.

All available Microsoft Outlook contacts are listed on the left side and the contacts that are already in your phone are listed on the right side.

4. Select the desired contacts on the left hand side and click **Add >>**.

Selected Microsoft Outlook contacts are moved to the contacts list in your phone.

5. Click **Save**.

The contacts are now available under  in your phone.

9 Presence Information

Presence Information is used to inform callers if you are present or not, and when you will return if you are not in the office at the moment. Available absence reasons are, for example, *Lunch*, *Busy*, *Vacation*, *Meeting* and *Trip*. Callers are informed by the operator of your whereabouts or with a text message on the display if the calling party is internal.

For some of the absence reasons, you are prompted to specify the return time.

If you are authorized, you can also enter presence information for another extension from your extension.

Note: Your phone can be used for outgoing calls even if an absence reason is selected. You will hear a special dial tone when you lift the handset.

9.1 Selecting an Absence Reason

To select an absence reason, do the following:

1. Press **Availability**, and select **My Presence**
2. A list of absence reasons is displayed. Scroll the list with the navigation keys
3. Choose an absence reason and press **Select**.
4. If required, enter date or time of return, and press **Set**.

The Follow-me lamp is lit and the display shows the selected reason.

9.2 Canceling Absence

To remove an absence reason, do the following:

1. Press the **Follow-me** key.

OR

1. Press **more....**
2. Select **Disable all diversions**, and press **Select**.

OR

1. Press **Availability**.
2. Select **My Presence**.
3. Select **Available**.

10 Messages

When you receive a message, the messages key  on your phone is flashing, and “Messages” is shown in the display. If a message is received during a call, a beep notifies the user. The lamp keeps flashing until you press the messages button.

10.1 Voice Mail

Your phone can be connected to a Voice Mail application. Contact the system administrator for more information and see separate instructions for the application.

The Voice Mail application allows you to leave a voice message to the caller when you are unable to answer calls, for example when you are out of office, or in a meeting. The caller can then leave a message in your mailbox. When you return to your office you can enter your mailbox and listen to the received messages.

If you use the Personal Number feature, it is recommended that you program Voice Mail as the last answering position for all search profiles. See 7.3 Personal Number and Profiles on page 62 for more information on Personal Number.

When you enter your mailbox, you will receive voice instructions on how to handle listening, recording, storing and deleting messages, and changing your security code.

Note: To be able to use the mailbox system, your extension must be correctly configured. Contact the system administrator for more information.

10.1.1 Listening to VoiceMail Messages

To check and listen to received voice mails, do the following:

1. Press and hold 1.

If the following message is displayed, the voice mail number should be configured to 1: “Not programmed! Program VoiceMail?” See 10.1.2 Programming VoiceMail Number on page 76.

2. Follow the recorded instructions.

OR

1. Press .

2. Select **My VoiceMail**, and press **Call**.

If the following message is displayed, the voice mail number should be configured to **Call**: “Not programmed! Program VoiceMail?” See 10.1.2 Programming VoiceMail Number on page 76.

3. Follow the recorded instructions.

Note: The phone can be configured so that you can directly call the voicemail system by pressing  without having to also select My VoiceMail (step 2).

10.1.2

Programming VoiceMail Number

If you receive the following message when you are trying to call your VoiceMail, you should program the VoiceMail: “Not programmed! Program VoiceMail?”

To program a VoiceMail number, do the following:

1. Press **Yes**.
2. Enter the VoiceMail number.

If you do not know the number to the VoiceMail, please contact the system administrator.

3. Press **Done**.

10.1.3

Programming My Messages Number

If your phone can be connected to an additional message server, you can program the number of this server to **My Messages**.

To program a number for My Messages, do the following:

1. Press .
2. Select **My Messages**, and press **Call**.
3. If the following message is displayed, the voice mail number should be configured to **Call**: “Not programmed! Program Messages?”
4. Press **Yes**.
5. Enter the number to the message server

If you do not know the number to the message server, contact the system administrator.

6. Press **Done**.

10.2 Manual Message Waiting (MMW)

The Manual Message Waiting (MMW) feature enables you to send and receive message waiting signals when the line is busy.

- MMW allows you to send a message waiting signal to an extension that does not answer when you call (if this feature is allowed, this is set by the system administrator).
- MMW allows you to receive a message waiting signal from someone who has tried to contact you.

10.2.1 Calling the Party That Requested MMW

If there is a message waiting for you, “Messages” appears in the display, and the indicator corresponding to  is flashing. To check who left the MMW, and to call this person, do the following:

1. Press .
New from [*number or contact that left MMW*] is selected.
2. Press **Call**.
The person who left the MMW is called.

or

1. Lift the handset and wait for the dial tone.
2. Dial *32#, or dial the number of the message retrieval center.
3. Replace the handset.

After the call, “Messages” still appears in the display, and the indicator is still flashing. You have to remove the MMW indication manually.

To remove an MMW indication manually, do the following:

1. Press .
New from [*number or contact that left MMW*] is selected.
2. Press **more....**
3. Select **Delete & Exit Messages**, and press **Select**.

10.2.2 Ordering an MMW Indication

To order MMW to another extension, do the following:

- 1) Lift the handset and wait for a dial tone.
- 2) Dial * 31 * *extension number* #.

- 3) Replace the handset.

10.2.3

Canceling an MMW Indication

To cancel a MMW indication that you have sent to another extension, do the following:

- 1) Lift the handset and wait for a dial tone.
- 2) Dial # 31 * *extension number* #.
- 3) Replace the handset.

11 Group Features

Most of the time, you will be working in a team, for example within an department. The telephony system and your phone offer services designed especially for working as a team. You have the possibility to supervise your colleague's extensions, ensuring call coverage. You can also call a colleague or intercept calls for each other. Your extension can also be a member of a hunt group, within your own department or another department. Calling parties can call this hunt group when they want to contact someone within your department.

These are group features available:

- Group Call Pickup
- Group Hunting
- Group Do Not Disturb
- Call Park Pool

11.1 Group Call Pickup

People working in a team can have their phones programmed by their system administrator to form *call pickup groups*.

A call pickup group consists of a number of extensions (members) that have been assigned a common sequence number (group) number. A member of a group can "pick up" calls to any other member in the same group simply by dialing a procedure on their telephone

11.1.1 Own Group

If you are a member of a call pickup group, you can answer calls to any other member (extension) in the group.

To answer a call to a call pickup group, do the following:

- 1) Lift the handset and wait for a dial tone.
- 2) Press *8# to answer the call.

11.1.2 Alternative Answer Group

One call pickup group can serve as an alternative group for another call pickup group. You are only able to answer calls to the alternative group

if there are no calls to your own group. The procedure is the same as for answering calls to your own group.

11.2 Group Hunting

An internal hunt group number is a common directory number for a group of extensions. Calls to the group will be indicated at a free extension in the group.

11.2.1 Answering a Group Call

A group call is answered in the normal way.

11.2.2 Leaving a Group Temporarily

By ordering Follow-me to your own extension number, you can leave an internal group hunting group temporarily.

To leave a group hunting group temporarily, do the following:

- 1) Press **Availability**, select **Follow-me**.
- 2) Enter your own extension number as follow-me number.

FollowMeTo is shown in the display. The follow-me lamp is lit.

11.2.3 Reentering the Group

To reenter an internal group hunting group, you have to cancel the follow-me to your own extension number.

To reenter a group hunting group, do the following:

1. Press the Follow-me key.

OR

1. Press **more....**
2. Select **Disable all diversions**, and press **Select**.

11.3 Group Do Not Disturb

A number of extensions can be defined as a *do not disturb* group. A categorized extension can activate *do not disturb* for the whole group. The

calls will be forwarded to an answering position defined for the whole group or the calling party receives a number unobtainable tone.

An extension with *group do not disturb* activated can still make outgoing calls as usual.

11.3.1 To Order Group Do Not Disturb

A categorized extension can activate *group do not disturb* by dialling the following procedure:

- Lift the handset (dial tone)
- Dial *25*group number# (special dial tone)
- Replace the handset

11.3.2 To Cancel Group Do Not Disturb

A categorized extension can deactivate *group do not disturb* by dialling the following procedure:

- Lift the handset (dial tone)
- Dial #25*group number# (special dial tone)
- Replace the handset

11.3.3 Bypass of Group Do Not Disturb

A categorized extension or a PBX operator can bypass *group do not disturb* by dialling the following procedure:

- Lift the handset (dial tone)
- Dial *60*extension number#

The call is indicated on the telephone with the dialed extension number.

11.4 Call Park Pool

You can park a call and transfer the call to a specific directory number (also called Call Park Pool) and any extension can pick up the call. If the call is not picked up within a few minutes, the call will recall your extension.

Transfer the call to the call park pool:

- You have an active call

- Press line 2 to put the call on hold and dial the number to the call park pool.
- Note the number (here called B-number) that shows up on the display.
- Press the **Transfer** softkey. Inform the person that shall take the call that he/she shall pickup the call on the B-number.

Pick up a call that is parked in the call park pool:

- Dial the B-number that you received from your colleague.
- When you hear the busy tone, press the **CallPickUp** softkey to pick up the call.

12 Other Useful Features

This chapter describes features such as *Account code*, *Authorization code*, *Personal number*, and *Alarm Extension*.

12.1 Account Code

The *account code* feature is used to charge a call to an account number or to prevent unauthorized calls from your phone.

Account codes allows you to keep track of where different outgoing calls are charged. The account code feature enables you to do the following:

- have calls charged to a specified account, representing a particular project, department or client, rather than to the calling extension number.
- prevent unauthorized calls to external numbers by requiring the extensions to dial an account code before dialing an external number

An account code can be entered either before or during an outgoing call. The code can be between 1 and 15 digits long.

12.1.1 Dialing an Account Code Before a Call

To dial the account code before dialing the destination number, do the following:

- 1) Lift the handset.
- 2) Dial *61* *account code* #.
Wait for a dial tone.
- 3) Dial the external number.

12.1.2 Dialing an Account Code During a Call

It is possible to connect an ongoing external call to an account code.

To dial the account code during an ongoing call, do the following:

1. Press **Hold**.
2. Dial *61* *account code* #.

Wait for a dial tone.

3. Press **more...**, select **Retrieve** [*call on hold*], and press **Select**.

12.2 Authorization Code

Authorization codes are used to control or limit the access to an extension. When an extension is controlled by an authorization code, certain service profiles are not allowed to use certain features, such as making calls to other countries. If you dial the authorization code, you open up the extension to use more features.

There are two kinds of authorization codes:

- Common authorization code: A common authorization code can be dialed from any extension.
- Individual authorization code. An individual authorization code is always associated with a specific extension.

An authorization code must be entered before the call. The code is between 1 and 7 digits long.

12.2.1 Common Authorization Code

Depending on the *service profile* associated with your extension, you may have to enter a common authorization code in order to make certain types of calls, and to lock and unlock the extension.

Note: The common authorization code can only be changed by the system administrator.

The common authorization code provides the following functions:

- Locking and unlocking of an extension. A locked extension uses a low service profile.
- Authorization code dialing. The calling party may use other categories or service profiles than those specified for the extension.

12.2.1.1 Dialing From an Extension

To make a call from an extension with a common authorization code, do the following:

1. Dial **72* authorization code #*.

Wait for a verification tone. If the code is not verified, the default common service profile will be used.

2. Dial the external number.

Note: If the service profile for the dialed authorization code is too low for the call, the call is rejected.

12.2.1.2 Locking Extension

To lock an extension with a common authorization code, do the following:

1. Dial **73* authorization code #*.
Wait for a verification tone.
2. When you hear a verification tone and the lock icon appears in the display, the extension is locked.

If you wish to make a call from a locked phone, different service profiles will be used depending on whether you enter an authorization code or not.

- When the telephone is locked, you have to dial **72** in order to acquire a higher level of service profile. If you do not enter an authorization code, the default service profile will be used.
- If you enter a valid authorization code, the service profile associated with the authorization code will be used.

12.2.1.3 Unlocking an Extension

To unlock an extension with a common authorization code, do the following:

- Dial *#73* authorization code #*.
When you hear a verification tone and the lock icon disappears from the display, the extension is unlocked.

Note: If the telephone is unlocked, you do not have to dial any authorization code.

12.2.2 Individual Authorization Code

If your extension has an *individual authorization code* associated with it, you can lock your own extension to a service profile when, for example, you are out of the office. Temporarily, you can call from another telephone and get the same service profile as for your own extension.

The individual authorization code provides three different functions:

- Locking and unlocking of an extension. A locked extension uses a low service profile.

- Authorization code dialing. The calling party may use other service profiles than those specified for the extension.
- Changing of authorization code from the phone. This enables the user of the authorization code to change the code when suitable.

12.2.2.1 **Dialing From Own Extension**

To make an authorization code call from your own extension with an individual authorization code, do the following:

- 1) Dial **75* authorization code #*.
Wait for a verification tone.
- 2) Dial the desired number.

If the service profile for the dialed external number is too low for the call, the call is rejected.

12.2.2.2 **Dialing From Other Extension**

To make a call from an extension with an individual authorization code (using another phone), do the following:

- 1) Dial **75* authorization code * own extension number #*.
Wait for a verification tone.
- 2) Dial the external number.

If the service profile for the dialed external number is too low for the call, the call is rejected.

12.2.2.3 **Locking an Extension**

To lock an extension with an individual authorization code, do the following:

- 1) Dial **76* authorization code #*.
- 2) When you hear a verification tone and the lock icon appears in the display, the extension is locked.

If you wish to make a call from a locked phone, different service profiles will be used depending on whether you enter an authorization code or not.

- If you do not enter an authorization code, the default service profile will be used.
- If you enter a valid authorization code, the service profile associated with the authorization code will be used

12.2.2.4 **Unlocking an Extension**

To unlock an extension with an individual authorization code, do the following:

- 1) Dial #76* *authorization code* #.
- 2) When you hear a verification tone and the lock icon disappears from the display, the extension is unlocked

12.2.2.5 **Changing the Authorization Code**

The individual authorization code can be changed from your own phone.

To change the individual authorization code for an extension, do the following:

- 1) Dial *74* *previous authorization code* * *new authorization code* #.
- 2) When you hear a verification tone, the individual authorization code has been changed.

Note: The authorization code will be changed only if the previous authorization code is valid.

12.3 **Alarm Extension**

An alarm extension is assigned characteristics similar to an alarm centre. All calls to such an extension are automatically granted intrusion access if the extension is busy. Up to seven callers can be connected to the alarm extension at the same time.

An alarm extension cannot be assigned to an IP phone, but it is possible to call an alarm extension from an IP phone.

12.4 **Direct In-dialing**

Direct In-dialing is a feature that enables direct routing of incoming external calls to predefined extensions or groups. Usually, the exchange has a direct in-dialing feature, enabling external subscribers to call you directly without having to go through the operator.

Note: A call that is not serviced by a predefined extension can be rerouted to an operator or an alternate answering position.

12.5 Emergency State

In case of emergency, the operator is authorized to put the exchange into an emergency state. In such a situation, the exchange properties and rules as configured for emergency state prevail.

In emergency state, only extensions with the appropriate category will be permitted to initiate calls. If you have not been assigned this category and try to make a call, you will not receive a dial tone.

12.6 General Deactivation

General deactivation enables you to cancel a number of features in one single command. The following features are canceled with the general deactivation feature:

- Callback. All callbacks are cancelled.
- Follow-me and External follow-me
- Manual Message Waiting
- Flexible night service

To request a general deactivation, do the following:

- 1) Lift the handset and wait for a dial tone.
- 2) Dial #001#.
- 3) Replace the handset.

12.7 Malicious Call Tracing

If you are being disturbed by bothersome or malicious external incoming calls, it is possible to request number tracing from the network provider. Tracing can be invoked during or after an ongoing conversation. The external line can be held for a limited period of time.

When a malicious call is received, a signal can be sent to the switched telephone network (PSTN) before a call is disconnected. If the calling subscriber clears the call, the external line can be held for a limited period of time to invoke the malicious call tracing (MCT).

It is possible to assign a shortcut key to MCT. Contact the system administrator.

12.7.1 Ordering Malicious Call Tracing

To order MCT during a call, press the MCT shortcut key:

- If the request is accepted, the shortcut key indicator is lit, a text message is displayed, and an acceptance tone is heard.
- If the request is rejected, the shortcut key indicator flashes rapidly, a text message is displayed, and a reject tone is heard

Note: If no shortcut has been programmed, press **Hold** and dial *39#.

12.8 Direct Inward System Access (DISA)

If you are assigned to use the Direct Inward System Access (DISA) feature and you are working externally, you can call your office and get access to an external line in order to make business calls. The business call will be charged to your office extension number or an account number. You will only be charged for the call to the office.

The external phone must be of push button type provided with a pound key (#) and a star key (*), or a mobile phone adapted for dial tone pulses (DTMF). After a completed call you must hang up before a new call can be made.

The procedure varies depending on whether you use an account code or not, and whether you use a common or individual authorization code.

12.8.1 Calling With a Common Authorization Code

1. Call the DISA feature at your office.
Wait for dial tone.

2. Dial **72* authorization code #*.
Wait for a dial tone.
3. Dial the external number.

12.8.2 Calling With an Individual Authorization Code

1. Call the DISA feature at your office.
Wait for a dial tone.
2. Dial **75* authorization code **.
Wait for a dial tone.
3. Dial the external number.
Wait for a dial tone.
4. Dial your *own extension number* and press #.
5. Dial the external number.

12.9 Night Service

When the telephony system is in *night service mode*, all incoming calls to the operator are transferred to a selected extension or group of extensions. Night service mode is used outside business hours.

12.9.1 Common Night Service

Common night service means that all incoming calls are routed to one designated extension. Calls are answered in the normal way.

12.9.2 Individual Night Service

Individual night service means that one or more external lines in the exchange are routed to the designated extension. Calls are answered in the normal way.

12.9.3 Flexible Night Service

Flexible night service means that the operator can reroute calls to a certain extension during restricted hours.

Flexible night service permits you to select an external line and connect it directly to Line 1 or 2 on your phone.

This is convenient when you expect important calls after office hours and wish to get them without delay. Details about external line numbers can be obtained from the operator.

Note: Flexible night service is only available for manual lines.

12.9.3.1

Activating flexible night service

To activate flexible night service, do the following:

- 1) Lift the handset and wait for a dial tone.
- 2) Dial *84* *route number* * *external line number* #.
- 3) Replace the handset.

12.9.3.2

Deactivating flexible night service

To deactivate flexible night service, do the following:

- 1) Lift the handset and wait for a dial tone.
- 2) Dial #84#.
- 3) Replace the handset.

Note: The flexible night service is deactivated automatically one hour after the exchange has been switched back into day service (if the service has been active for at least one hour). This way you do not have to be concerned about forgetting to deactivate the flexible night service for your extension.

12.10

Individual Do Not Disturb (DND)

You can activate this feature when you want to avoid incoming calls to your telephone. The calling party receives a number unobtainable tone or a busy tone or will be forwarded to the diversion position if it is defined by the system administrator.

12.10.1

To Order Do Not Disturb

- 1) Lift the handset (dial tone).
- 2) Dial *27#
- 3) Replace the handset.

- 4) A text in the display reminds you that DND is activated.
The telephone can still be used for outgoing calls as usual.

12.10.2

To Cancel Do Not Disturb

- 1) Lift the handset (special dial tone).
- 2) Dial #27#. Dial tone
- 3) Replace the handset.

12.11

Monitoring Keys

A monitoring key (or MNS key) is a key that allows you to monitor and answer calls to other extensions, as well as make calls to the monitored extension.

Note: MNS keys are programmed as a shortcut keys by the system administrator.

The monitoring feature is especially useful in Boss-Secretary applications.

You answer a call to an monitored extension by pressing the shortcut key which the extension has been programmed to.

The shortcut displays one of the following status indications:

- **The indicator lamp is off:** The monitored extension is free.
- **The indicator lamp is flashing fast:** The monitored extension has an incoming call waiting to be answered.
- **The indicator lamp is on:** The monitored extension is busy.
- **The indicator lamp is flashing slowly:** The monitored extension is put on hold.

Note: When you log on to another IP phone, all monitoring keys are moved automatically to the new phone.

The only data that the user can change for a MNS-key, is type of alerting, see 13.3.2.2 Changing Alert For Monitored Extensions on page 102.

12.12

Boss - Secretary

The purpose of the feature Boss-secretary is to allow the boss and secretary to control the diversion of incoming calls for the boss tele-

phone. This is the difference compared to the case with Monitoring key (MNS key) where the secretary can only answer the calls to the boss.

While the function is active, the calls to the boss telephone will be announced on the telephone of the secretary, and the corresponding Personal Number (PEN) key lamp will indicate that the service is on for both the boss and secretary telephones. The service can be activated and deactivated by both the boss and the secretaries by pressing the PEN key associated with the boss.

When the function is inactive, the PEN key lamp is off at both the boss and secretary telephones. The service can be directly deactivated by only pressing the previously active PEN key or indirectly deactivated by activating an other Personal Number list.

The PEN key is used to activate and deactivate Personal Number list 1.

12.12.1 Activate the Boss-Secretary feature

12.12.1.1 From the secretary's phone

Activate the Boss-Secretary feature from the secretary's phone

- Press the PEN key associated to the boss.

The PEN key lamp is lit on the secretary's phone.

The PEN key lamp is lit and **Profile 1** is shown in the display on the phone of the boss.

When there is a call to the boss, it is announced on the secretary's phone and the display shows:

<Name of the boss> Redirect	
67609 Alice	
Reject	Answer

In the example above Alice with extension number 67609 is calling the boss.

To answer the call in the secretary's phone:

- Lift the handset
- or
- Press the speaker key (to answer in handsfree mode)

12.12.1.2 From the phone of the boss

Activate the Boss-Secretary feature from the telephone of the boss.

- Press the PEN key.

The PEN key lamp is lit and **Profile 1** is shown in the display on the phone of the boss.

The PEN key lamp is lit on the secretary's phone.

When there is a call to the boss, it is announced on the secretary's phone as shown above.

12.12.2 Deactivate the Boss - Secretary feature.

12.12.2.1 From the secretary's phone

Deactivate the Boss-Secretary feature from the secretary's phone

- Press the PEN key associated to the boss.

The PEN key lamp is turned off on the secretary's phone.

The PEN key lamp is turned off and **Profile 2** is shown in the display on the phone of the boss.

When there is a call to the boss, it is announced on the phone of the boss.

12.12.2.2 From the phone of the boss

Deactivate the Boss-Secretary feature from the telephone of the boss.

- Press the PEN key.

The PEN key lamp is turned off and **Profile 2** is shown in the display on the phone of the boss.

The PEN key lamp is turned off on the secretary's phone.

When there is a call to the boss, it is announced on the boss' phone.

12.13 Recording

It is possible to record your calls to a central recording equipment, if the system administrator has initiated this feature.

There are two options:

- The type of calls to be recorded are defined in the recording equipment by the system administrator. You do not have to do anything to start the recording. As soon as a call is recorded the lamp at the **Recording** key is lit.
- The recording starts when you press the **Recording** key. When the recording starts, the the lamp at the **Recording** key is lit.

The **Recording** key must be initiated by the system administrator.

Which of these options that is used in your system is dependent on the system configuration.

13 Settings

This section describes how to change settings for the phone.

13.1 My Availability Settings

It is possible to specify availability status for:

- My Presence
- Follow-me
- External follow-me
- My profile
- My mobile phone
- Free on busy

13.1.1 My Presence

To modify the presence status, do the following:

1. Press , select **My Availability**.
2. Select **My Presence**.
3. Select the desired absence reason, and enter the return time and date if required and press **Select**.

13.1.2 Follow-me

To edit your follow-me number, do the following:

1. Press , select **My Availability**.
2. Select **Follow-me**.
3. Enter the extension number of the answering position and press **Done**.

13.1.3 External Follow-me

To edit your external follow-me number, do the following:

1. Press , select **My Availability**.

2. Select **External Follow-me**.
3. Enter the external access code and the phone number and press **Done**.

13.1.4 My Profile

To edit your profile number, do the following:

1. Press , select **My Availability**.
2. Select **My Profile**.
3. Enter the number of the profile (personal number list) and press **OK**.

13.1.5 My Mobile Phone

To edit your mobile phone number, do the following:

1. Press , select **My Availability**.
2. Select **My mobile phone**, and press **Select**.
3. Enter the external access code followed by your mobile phone number and press **Done**.

13.1.6 Free On Busy

To activate free on busy, do the following:

1. Press , select **My Availability**.
2. Select **Free on busy**, and press **Select**.
3. Scroll and select **ON put call through**, and press **Select**.

13.2 Shortcuts

This section describes how to program shortcuts.

13.2.1 Adding New Manual Input

To add a shortcut, do the following:

1. Press  .
2. Select **Shortcuts**, and press **Select**.

The following message is displayed: "Select a Shortcut by pressing the key!"

3. Press the key to program as a shortcut.
4. Press **more....**
5. Select **Add new manual input**, and press **Select**.

You get prompted for shortcut data.

6. Enter data, such as an extension number or an external number, and press **OK**.
7. Press **Done** to save the shortcut.

Press **more...** to edit the data or label before saving.

13.2.2

Adding New Shortcut From Call List

To add a shortcut from the call list, do the following:

1. Press .
2. Select **Shortcuts**, and press **Select**.

The following message is displayed: "Select a Shortcut by pressing the key!"

3. Press the key to program as a shortcut.
4. Press **more....**
5. Select **Add new from Call List**, and press **Select**.
6. Select a number from the call list, and press **Add**.
7. Press **Done** to save the shortcut.

Press **more...** to edit the data or label before saving.

13.2.3

Adding New Shortcut From Contacts

To add a shortcut from your contacts list, do the following:

1. Press .
2. Select **Shortcuts**, and press **Select**.

The following message is displayed: "Select a Shortcut by pressing the key!"

3. Press the key to program as a shortcut.
4. Press **more....**

5. Select **Add new from Contacts**, and press **Select**.
6. Select a entry from the contacts list, and press **Add**.
7. Press **Done** to save the shortcut.
Press **more...** to edit the data or label before saving.

13.2.4 Editing a Shortcut

To edit a shortcut, do the following:

1. Press  .
2. Select **Shortcuts**, and press **Select**.
The following message is displayed: "Select a Shortcut by pressing the key!"
3. Press the shortcut to edit.
4. Press **more....**
5. Select **Edit Data** or **Edit Label** in the scroll list, and press **Select**.
6. Make the changes, and press **OK**, and then **Done** to confirm the change.

Note: Press **more...** and select **Erase** or **Erase all** to correct a faulty entry. It is also possible to press the volume down button to erase entered characters.

13.2.5 Deleting a Shortcut

To delete a shortcut, do the following:

1. Press .
2. Select **Shortcuts**, and press **Select**.
The following message is displayed: "Select a Shortcut by pressing the key!"
3. Press the shortcut to delete and press **more....**
4. Scroll to **Delete [selected shortcut]**, and press **Select**.
A confirmation message is displayed.
Note: Select **Delete all shortcuts** if you want to delete all your phone shortcuts.
5. Press **Yes** to confirm.
The following message is displayed: "Shortcut deleted!"
6. Press **OK** to return to Shortcuts menu.

13.3 Sounds

This section describes how to change ring signals and alert signals for incoming calls from the settings menu **Sounds**.

Note: You can change the ring signal for individual contacts, see 8.3.3 Editing the Ring Signal on page 68.

13.3.1 Changing Ring Signals for Incoming Calls

A ring signal can be either a traditional ring signal or a melody that you download from a server.

To change the ring signal for an incoming call, do the following:

1. Press .
2. Select **Sounds** and press **Select**.
3. Select **Ring Signals** and press **Select**.
Default Ring Signals is selected.
4. Press **Select**.
5. Scroll with the navigation keys to the ring signal or melody you wish to use and press **Select**.

Note: To listen to a ring signal or melody before selecting it, press **more...** and then **Play**.

6. Press **Yes** to confirm.

13.3.1.1

Downloading Melodies

Instead of standard ring signals, you can download up to 10 melodies to your phone.

To download a melody from a specified server, do the following:

1. Press .
2. Select **Sounds** and press **Select**.
3. Select **Ring Signals** and press **Select**.
Default Ring Signals is selected.
4. Press **Select**.
5. Navigate to **Melody 1 (empty)** and press **Add**.
A list of all available melodies is displayed.
6. Select a melody and press **Select**.

Note: If you wish to listen to a signal or melody before selecting it, press **more...** and then **Play**. When you are done listening to a signal, press **Stop**.

13.3.2

Alert Type

With the Aastra 7434ip phone, it is possible to change the way the phone rings for incoming calls (1st call and 2nd or 3rd call), and for monitored extensions.

The following alerting types are available:

Visual only

The signal is muted, but the indicator on the line key where the call is received is flashing.

Periodic

The ring signal alerts periodically.

Delayed Periodic

There is a delay before the first ring signal. The length of the delay can be changed by the system administrator.

One muted

The phone rings once, then the signal is muted.

Delayed one muted

There is a delay before the ring signal. After one ring, the signal is muted. The length of the delay can be changed by the system administrator.

13.3.2.1**Changing Alert For Incoming Calls**

To change the alert signal for incoming calls, do the following:

1. Press .
2. Select **Sounds** and press **Select**.
3. Select **Alert** and press **Select**.
4. Select **Alert 1st call** or **Alert 2nd or 3rd call**, and press **Select**.
5. Select an alert, and then press **Set**.

13.3.2.2**Changing Alert For Monitored Extensions**

To change the alert signal for monitored extensions, do the following:

1. Press and hold the monitored extension shortcut.
The extension number, the label, the ring signal and alert type are displayed.
2. Press **more....**
3. Select **Edit Alert**, and press **Select**.
4. Select an alert, and then press **Set**.
A confirmation message is displayed.
5. Press **Yes**

It is also possible to change the alert signal by pressing , selecting **Shortcuts**, and then pressing the shortcut for the monitored extension.

13.4**Display**

This section describes how to change the display contrast, brightness and brightness hold time, that is, how long the display will be illuminated.

13.4.1**Modifying Contrast**

To modify the phone contrast, do the following:

1. Press  .
2. Select **Display** and press **Select**.
3. Scroll to **Phone Contrast** and press **Select**.
4. Press the navigation keys, or the volume keys, to increase or decrease the contrast to a desired level.
5. Press **Set** and then **Yes** to confirm.
Your setting is saved.

13.4.2

Modifying Brightness

To modify the phone brightness, do the following:

1. Press  .
2. Select **Display** and press **Select**.
3. Scroll to **Phone Brightness** and press **Select**.
4. Press the navigation keys, or the volume keys, to increase or decrease the brightness to a desired level.
5. Press **Set** and then **Yes** to confirm.
Your setting is saved.

13.4.3 Modifying Brightness Hold Time

To modify the brightness hold time, do the following:

1. Press .
2. Select **Display** and press **Select**.
3. Scroll to **Brightness Hold time** and press **Select**.

You can modify the hold time to 1, 2, 5, 10, 30 or 60 minutes.

4. Press the navigation keys, or the volume keys, to set the desired brightness hold time.
5. Press **Set** and then **Yes** to confirm.

Your setting is saved.

13.5 Language

This section describes how to change language and character set on your phone.

Note: There are several languages and character sets available for the phone. They are enabled by the system administrator.

13.5.1 Display Menus

To change the display menu language, do the following:

1. Press .
2. Scroll to **Language**, and press **Select**.
3. Select **Display Menus** and press **Select**.

The default language is displayed, along with a list of available languages for the menus.

4. Use the navigation keys to scroll the list and select the desired language, and press **Set**.
5. Press **Yes** to confirm, or **No** to cancel.

Note: The phone must be registered to the PBX, otherwise it is not possible to change the language. Also, the selected language must be available in the PBX.

13.5.2 Keypad Characters

To change the keypad character set, do the following:

1. Press .
2. Scroll to **Language**, and press **Select**.
3. Select **Keypad Characters**, and press **Select**.

The default character set is displayed, along with a list of available character sets for the keypad.

4. Use the navigation keys to scroll the list and select the desired character set, and press **Set**.

A confirmation message is displayed.

5. Press **Yes** to confirm, or **No** to cancel.

13.6 Time and Date

This section describes how to change the time and date format in the display.

13.6.1 Modifying Time Format

To modify the time format, do the following:

1. Press .
2. Select **Time & Date**, and press **Select**.
3. Select **Time Format**, and press **Select**.
4. Use the navigation keys to select the format, and press **Set**.
5. Press **Yes** to confirm.

13.6.2 Modifying Date Format

To modify the date format, do the following:

1. Press .
2. Select **Time & Date**, and press **Select**.
3. Select **Date Format**, and press **Select**.
4. Use the navigation keys to select the format, and press **Set**.
5. Press **Yes** to confirm.

13.7 Option Unit

In section 2.12 Option Unit on page 27, you will find the detailed information on the option unit and how you install it.

To modify the option unit settings, do the following:

1. Press .
2. Select **Option Unit**, and press **Select**.
Note: **Option Unit** is available only when an option unit is installed.
3. Select **Busy signal**, **Extra bell**, or **Combined Bell/Busy**, and press **Select**.

13.8 Security and Access

It is possible to view and change the PIN code, if this option has been configured by system administrator.

13.8.1 Changing PIN Code

You can change the PIN code used for logging on to the telephony system. The PIN is the same as the individual authorization code, see 12.2 Authorization Code on page 84.

Note: Depending on the phone configuration, the menu option **Changing PIN** may not be available.

To change the PIN code, do the following:

1. Press .
2. Select **Security and Access**, and press **Select**.
3. Select **Change PIN** and press **Select**.
4. Enter the current PIN code, and press **OK**.
You will be prompted for a new PIN (1-7 digits).
5. Enter your new code, and press **OK**.
Note: Only digits can be used as PIN.
6. Enter the new code again for confirmation, and press **OK**.

13.9

Help

You can easily get information on which software version is installed on your phone, the phone IP address, and the phone web address.

To find this information, do the following:

1. Press  .
2. Scroll to **Help**, and press **Select**.
About Aastra 7434ip is displayed.
3. Press **Select**.
Software version is displayed.
4. Select **Phone IP Address** and press **Select** to see the IP address.
5. Select **Phone Web Address** and press **Select** to see the web address.

Note: Whether or not the **Phone Web Address** option is available in the **Help** menu, depends on how the phone is configured. Contact the system administrator for more information.

14 Web Interface

You can access your IP phone from a web interface. From the web, you can change the following settings:

- **Contacts**
 - **Add to contacts**
 - **Delete all contacts**
- **Call list**
 - **Delete call list**
- **Settings**
 - **Phone Shortcuts**



Note: If one (or more) KPU or DPU is attached to the phone, it is also possible to manage these shortcuts. Up to three panels can be visible; **Panel 1 Shortcuts**, **Panel 2 Shortcuts**, **Panel 3 Shortcuts**.

- **Sounds**
- **Security and Access**

To access the phone web interface, you need to know the phone web address or IP address. See 14.1 Phone IP Address on page 108 and 14.2 Phone Web Address on page 109 for descriptions on how to find this information.

14.1 Phone IP Address



To find out the IP address of the phone, do the following:

1. Press .
2. Select **Help** and press **Select**.
About Aastra 7434ip is displayed.
3. Press **Select**.
4. Select **Phone IP Address**, and press **Select**.
The IP address is displayed.
5. Press  to return to idle mode.

14.2 Phone Web Address

Whether or not the **Phone Web Address** option is available in the **Help** menu, depends on how the phone is configured. Contact the system administrator for more information.

To find out the web address of the phone, do the following:

1. Press  .
2. Select **Help** and press **Select**.
About Aastra 7434ip is displayed.
3. Press **Select**.
4. Select **Phone Web Address**, and press **Select**.
The web address is displayed.
5. Press  to return to idle mode.

14.3 Using the Web Interface

To use the phone through the web interface, do the following:

1. Enter the phone web address or IP address in the address field of your web browser.

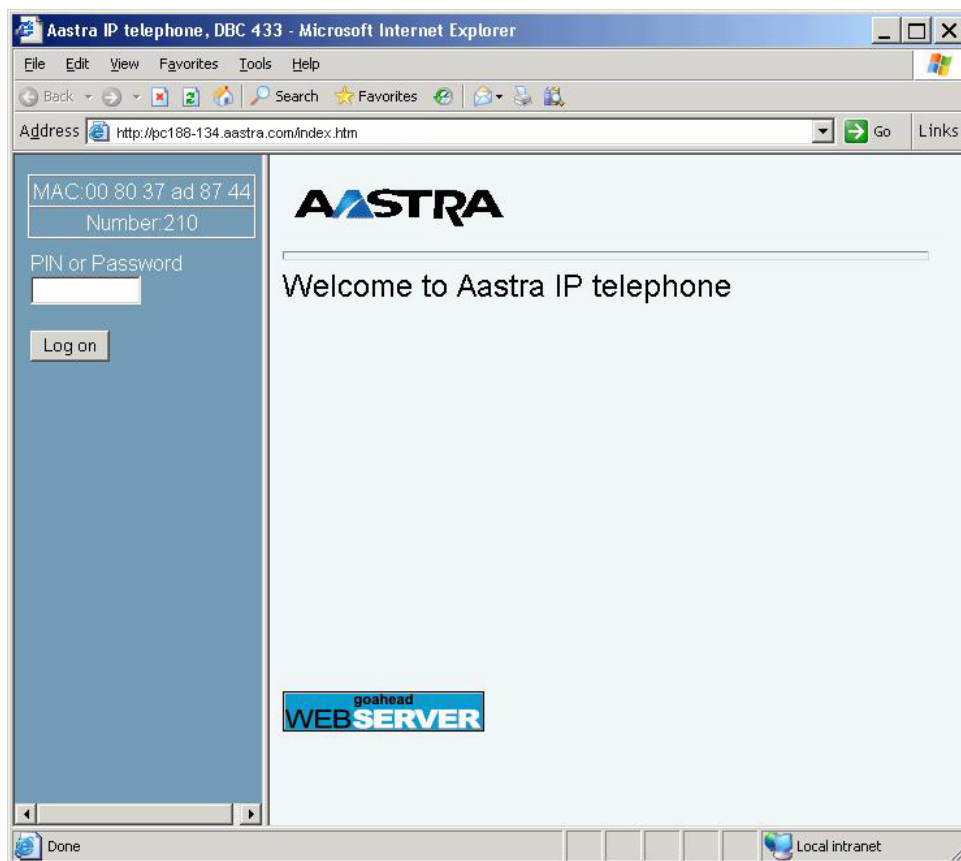

2. Enter your password (or PIN code) and click **Log on**.

Note: Use the same password (or PIN code) as you use to log on your phone. If you have no logon password (or PIN code), you cannot log on to the web interface, unless the system administrator has enabled the default password *Welcome*. If you have forgotten your password (or PIN code), contact the system administrator.

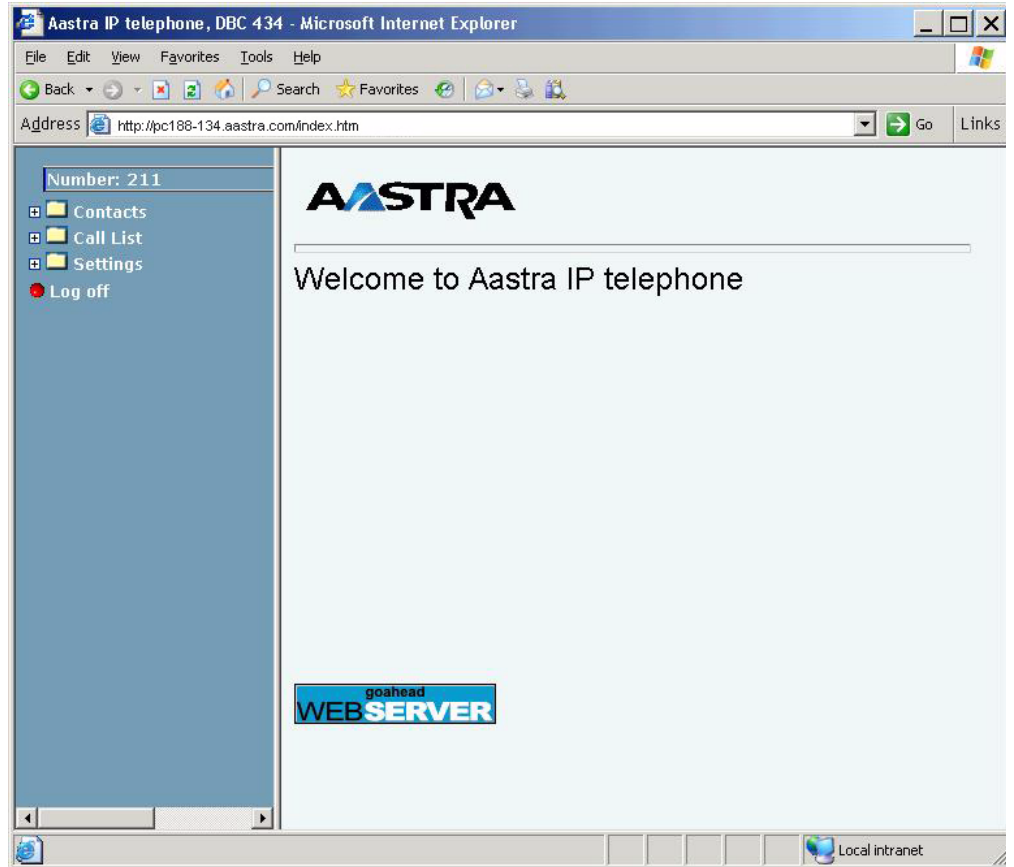

- Expand the folder(s) to start edit data.



To exit the web interface of the phone, press **Log off**.

14.3.1

Contacts Folder

Click **Contacts** to see a list of the contacts stored in your phone. If you expand the **Contacts** folder, you can add and delete contacts.

14.3.1.1

Adding a Contact

To add a new contact, do the following:

- Expand **Contacts**.
- Click **Add to contacts**.
- Enter name and number.
- Select a ring signal.
- Click **Add to contacts**.

The new name and number are saved.

14.3.1.2 Editing or Deleting a Contact

To edit or delete a name and number, do the following:

1. Click **Contacts**.
2. Click the name to edit or delete.
3. Do any of the following:
 - Make the changes and click **Save** to save.
 - Click **Delete** to delete the current name and number.
 - Click **Back** to exit the edit and delete menu without any changes.

14.3.1.3 Deleting All Contacts

To delete all your contacts, do the following:

1. Expand **Contacts**.
2. Click **Delete contacts**.
A confirmation message is displayed.
3. Click **OK** to delete all names and numbers.

14.3.2 Call List Folder

Click **Call List** to see calls to and from your phone. From the web interface, it is possible to make a call to a number in the list and delete items from the list. It is also possible to add call list numbers to your contacts.

14.3.2.1 Editing or Deleting a Name And Number

To edit or delete a number, do the following:

1. Click **Call List**.
2. Click a name (or -) from the **Name field** in the table.
3. Do any of the following:
 - Edit the name, number or ring signal, and click **Add to contacts**. Otherwise, just click **Add to contacts**.
 - Click **Delete** to delete the current call from the list.
 - Click **Call** to call the number.
 - Click **Back** to exit the edit and delete menu without any changes.

14.3.2.2 Deleting All Names And Numbers

To delete all names and numbers from the call list, do the following:

1. Expand **Call List**.
2. Click **Delete call list**.
A confirmation message is displayed.
3. Click **OK** to delete the call list.

14.3.3 Settings - Shortcuts

1. Expand **Settings**.
The submenus are shown.
2. Click the submenu to be changed:
 - **Phone Shortcuts**
 - **Panel 1 Shortcuts**
 - **Panel 2 Shortcuts**
 - **Panel 3 Shortcuts**

A table with the current programming for each key is shown. The table shown corresponds to how the keys are placed on the phone or on the panel unit.

Note: Text that is not underlined, means it is a fixed key and can only be changed by the system administrator.

14.3.3.1 Programming a Shortcut

To create a shortcut, do the following:

1. Select the key to be programmed.
2. Enter the number or code.
3. Click **Save**.

The key table is shown with the new number or code.

14.3.3.2 Editing a Shortcut

To edit a shortcut, do the following:

1. Click the underlined number or code for the key to be changed.
2. Select the characters to be changed.

3. Enter new characters.
4. Click **Save**.

The key table is shown with the edited number or code.

14.3.3.3 Deleting a Shortcut

To delete a shortcut, do the following:

1. Click the underlined number or code for the key to be deleted.
2. Click **Delete**.

The key table is shows a “_” for that key.

14.3.4 Settings - Sounds

To change the hearing level settings, do the following:

1. Expand **Settings**.
The submenus are shown.
2. Click **Sounds**.
The current settings for **Default Ring Signal**, **Alert 1st Call**, and **Alert 2nd and 3rd Call** are displayed.
3. Make the desired changes by selecting values from the drop-down lists, and click **Save**.

14.3.5 Settings - Security and Access

To change the PIN code, do the following:



1. Expand **Settings**.
2. Click **Security and Access**.
3. Select **Change PIN**.

Enter phone number and old PIN code. Enter the new PIN code (the second time for confirmation).

4. Press **Apply**.

15 Troubleshooting

This section contains information on how to solve common operational problems, and warnings you may receive. Go through the following list if you encounter any problems. If this checklist does not cover the problem, contact the system administrator. If others have similar problems, there may be a system error.

Fault / Display	Probable cause	Action or comment
The phone is locked	Disturbance on the network.	Press    and # simultaneously for one or two seconds. This will restart the phone.
The access warning triangle appears in the display.	Disturbance on the network or in the telephony system.	Although some features may not work, the phone can be used for receiving and making calls. If the trouble persists, contact the system administrator.
No connection to network! (Message appears in the display)	There is no connection to the LAN.	Verify that the phone is connected to the network by checking the LAN cable between the LAN port and the phone.

16





List of Features and Procedures

Table 5 Features and Procedures summarizes the procedures available for the Aastra 7434ip phone.

Table 5 Features and Procedures

Features	Procedure
ACCOUNT CODE	*61* account code #
AUTHORIZATION CODE	
Common code:	
increase CoS	*72* authorization code #
lock extension	*73* authorization code #
unlock extension	#73* authorization code #
Individual (regional) code, RAC:	
dial with individual authorization code	*75* authorization code #
lock extension	*76* authorization code #
unlock extension	#76* authorization code #
change code	*74* old code * new code #
AUTOMATIC CALLBACK	
- to order:	
- busy extension or no reply	Press key 6
- busy external line	Press key 6
- to cancel:	
- busy extension or no reply	#37* extension number #
- busy external line	#37* external number #
- all ordered callbacks	#37#
BYPASS	*60* B-number #

CALL PICK UP	
- individual	Press key 8
- group	*8#
CALL WAITING	
- not applicable	
COMMON SPEED DIALING NUMBERS	see List of speed dialing numbers
CONFERENCE	Press soft key or shortcut key
EXTERNAL FOLLOW-ME	
- to order	*22# route access code and external number #
- to cancel	#22#
- to order from another extension	*22* extension number to divert # route access code and external number# North America: *23* extension number to divert # route access code and external number#
- to cancel from another extension	#22* diverted extension number # North America: #23* diverted extension number #
FOLLOW-ME	
- to order from own extension	*21* number of follow-me position #
- to cancel from own extension	#21#
- to cancel from answering position	#21* diverted extension number #
- to order new follow-me position	*21* diverted extension number * number of follow-me position #

-	to order from another extension	*21*extension number to divert * number of follow-me position#
-	to cancel from another extension	#21*diverted extension number#
	GENERAL DEACTIVATION	#001#
	INQUIRY	
-	to initiate	Line
-	to revert to original party	Press the line key where the original party is parked
	INTRUSION	Press key 4
	LAST EXTERNAL NUMBER REDIAL	***
	MANUAL MESSAGE WAITING	
-	to order	*31* extension number #
-	to cancel	#31#
-	to reply	*32#
	NIGHT SERVICE	
	Universal	8
	Flexible	
-	to order	*84* route number * external line number #
-	to cancel	#84#
	NUMBER PRESENTATION RESTRICTION	*42# B-number
	RESTART	Press   ,  and # simultaneously for at least one second.
	SOFTWARE VERSION	Press   , * and 4 simultaneously for at least one second.

TRANSFER	Press soft key or shortcut key
----------	-----------------------------------

17

Suffix Digits and Feature Codes

This section describes the country specific suffix digits and feature codes that are relevant for the Aastra 7434ip IP phone used in the MX-ONE environment.

The following application systems are concerned: Australia, Austria, Belgium, Brazil, China, Denmark, Export, Finland, France, Germany, Hong Kong A-law, Hong Kong My-law, Indonesia, Ireland, Italy, Malaysia, Mexico, The Netherlands, New Zealand, North America, Norway, Korea, Saudi Arabia, Singapore, South Africa, Spain, Standard, Sweden, Switzerland, and United Kingdom.

Suffix digits are entered as written. For Aastra 7434ip IP phones, you normally use dedicated keys.

Feature codes are entered as *code # for activation, and as #code # for deactivation.

Table 6 Standard and Alternative codes

Function	Standard codes	Alternative codes
Suffix digits		
Alternation on Inquiry	Line key	-
Conference	Soft key	Shortcut key
Intrusion	4	France: 8 New Zealand: 8 Sweden: 8
Call Waiting Indication	5	France: 6 New Zealand: 6 Sweden: 4
Call Back	6	France: 5 New Zealand: 5 Sweden: 5
Common Parking or Individual Call Pick-up	8	France: 4 New Zealand: 4 Sweden: 6
Feature Codes		
General Deactivation	001	North America: 0

Choice of Language	08	
Ordering or Cancellation of Active List (Personal Number)	10	
Follow Me	21	United Kingdom: 2
External Follow Me	22	North America: 23
Ordering or Cancellation of Interception Message	23	North America: 24
Print Interception Message	26	Sweden: N/A
Manual Message Waiting	31	
Cancellation of Message Waiting	31	North America: 56
Automatic Call Back, Cancellation	37	North America: 6
Malicious Call Tracing	39	
Calling Line Identification Restriction Per Call	42	
By-pass of Diversion	60	North America: 1
Account Code Predialing	61	Finland: 71 Norway: 71
Authorization Code Predialing	72	Germany: 75 The Netherlands: 75 North America: 6 Sweden: 75
Lock/Unlock Common Authorization Code	73	North America: 71
Change Individual Authorization Code	74	
Dial With Individual Authorization Code	75	Germany: 72 The Netherlands: 72 Sweden: 72
Lock/Unlock Individual Authorization Code	76	

Customer Identity Storage	77	
Answer on Group Call Pick-up, and Answer on Night Time Connection (* and # in the service code can be excluded)	8	Finland: 0 North America: 59 Sweden: 0
Ordering of Night Time Connection	84	North America: 8
Repetition of the Last External Number Dialed	***	Finland: **0 Sweden: **0