

**Akuvox** Smart Intercom



**R26C**



**R26P**

## **R26 Series Door Phone Admin Guide**

## About This Manual

Thank you for choosing Akuvox's R26 series door phone. This manual is intended for end users, who need to properly configure the door phone. This manual is applicable to 26.0.3.xx version, and it provides all functions' configurations of R26C/P. Please visit Akuvox forum or consult technical support for any new information or latest firmware.

**Note:** Please refer to universal abbreviation form in the end of manual when meet any abbreviation letter.

# Content

<b>1. Product Overview.....</b>	<b>1</b>
1.1. Product Description.....	1
1.2. Connector Introduction.....	2
1.3. LED Status Information.....	3
<b>2. Daily Use.....</b>	<b>4</b>
2.1. Make a Call.....	4
2.2. Receive a Call.....	4
2.3. Unlock by RFID Card (Optional).....	4
<b>3. Basic Features.....</b>	<b>5</b>
3.1. Access the Website Setting.....	5
3.1.1. Obtain IP Address.....	5
3.1.2. Access the Device Website.....	5
3.2. Password Modification.....	6
3.2.1. Modify the Web Password.....	6
3.2.2. Session Time Out.....	6

3.3. Phone Configuration.....	7
3.3.1. Time/Lang.....	7
3.3.2. Network.....	7
3.3.2.1. DHCP Mode.....	7
3.3.2.2. Static IP Mode.....	8
3.3.2.3. Local RTP.....	8
3.3.2.4. SNMP.....	9
3.3.2.5. VLAN.....	9
3.3.2.6. TR069.....	10
3.3.3. Sound.....	11
3.4. Intercom Call.....	12
3.4.1. Direct IP Call.....	12
3.4.2. SIP Call.....	13
3.4.2.1. SIP Account.....	13
3.4.2.2. SIP Server 1&2.....	14
3.4.2.3. Outbound Proxy Server.....	15

3.4.2.4. Transport Type.....	15
3.4.2.5. NAT.....	15
3.4.3. Auto Answer.....	16
3.4.4. Web Call.....	16
3.4.5. No Answer Call.....	17
3.4.6. Multicast.....	17
3.4.7. Push To Hang Up.....	17
3.5. Security.....	18
3.5.1. Live View.....	18
3.5.2. RTSP.....	18
3.5.3. ONVIF.....	20
3.6. Access Control.....	21
3.6.1. Relay.....	21
3.6.2. Card Setting (Optional).....	22
3.6.3. Open Relay via HTTP.....	23
3.6.4. Unlock via Exit Button.....	24

3.7. Reboot.....	25
3.8. Reset.....	25
<b>4. Advance Feature.....</b>	<b>25</b>
4.1. Phone Configuration.....	25
4.1.1. LED.....	25
4.1.2. IR LED.....	27
4.1.3. RF Card Code Display Related.....	27
4.2. Intercom.....	28
4.2.1. Call Time Related.....	28
4.2.2. Return Code When Refuse.....	28
4.2.3. SIP Call Related.....	29
4.2.4. Codec.....	30
4.2.5. DTMF.....	31
4.2.6. Session Timer.....	32
4.2.7. Encryption.....	32
4.2.8. NAT.....	32

4.2.9. User Agent.....	33
4.3. Access Control.....	33
4.3.1. Web Relay.....	33
4.4. Security.....	35
4.4.1. Anti-alarm.....	35
4.4.2. Motion.....	35
4.4.3. Action.....	36
4.4.3.1. Action Parameters.....	36
4.4.3.2. No Answer Action.....	38
4.4.3.3. Push Button Action.....	38
4.4.3.4. Input Interface Triggered Action.....	39
4.4.3.5. Motion Triggered Action.....	39
4.4.3.6. Action URL.....	40
4.5. Upgrade.....	40
4.5.1. Web Upgrade.....	40
4.5.2. Autop Upgrade.....	41

4.5.3. Backup Config File.....	43
4.5.4. DHCP Option.....	44
4.6. Log.....	44
4.6.1. Call log.....	44
4.6.2. Door Log.....	44
4.6.3. System Log.....	45
4.6.4. PCAP.....	45



# 1. Product Overview

## 1.1. Product Description

Akuvox R26X is a SIP-compliant, hands-free one button video outdoor phone. It can be connected with users Akuvox indoor monitors for remote access controlling and monitoring. Users can operate the indoor phone to communicate with visitors via voice and video, and use RFID cards to unlock the door (R26C only). It's applicable in villas, offices and so on.

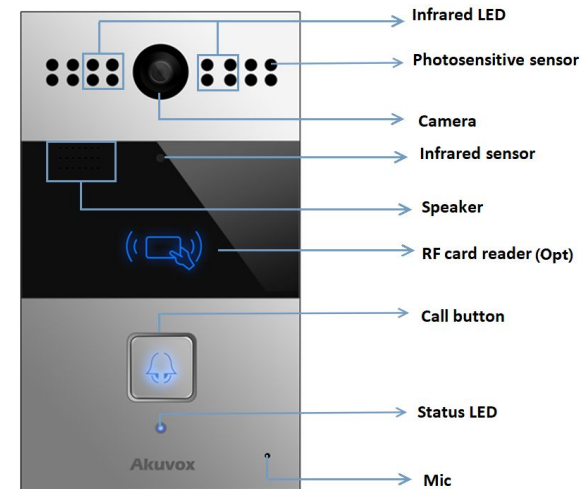

Figure 1.1 Product description

## 1.2. Connector Introduction

**Ethernet (POE):** Ethernet (POE) connector, which can provide both power and network connection.

**12V/GND:** External power supply terminal if POE is not available.

**RS485A/B:** RS485 terminal.

**DOORA/B:** Trigger signal input terminal.

**RelayA/B (NO/NC/COM):** Relay control terminal.

**Note:** The general door phone interface diagram is only for reference.

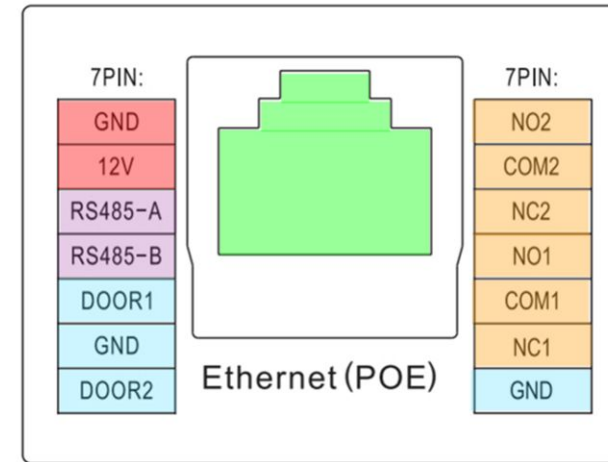

Figure 1.2-1 R26's interface

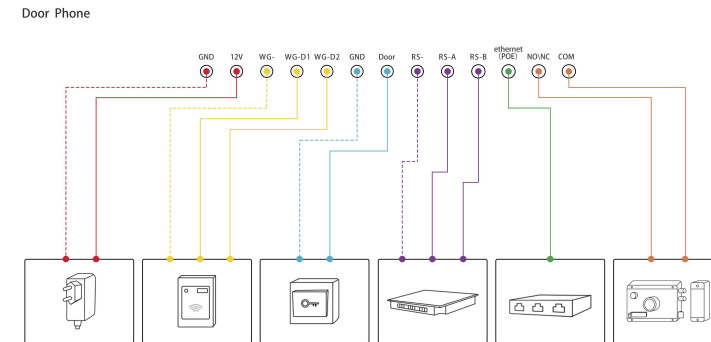

Figure 1.2-2 General interface

### 1.3. LED Status Information

LED Status		Description
Blue	Always on	Normal status
	Flashing	Calling
Red	Flashing	Network is unavailable
Green	Always on	Talking on a call
	Flashing	Receiving a call
Pink	Flashing	Upgrading

## 2. Daily Use

### 2.1. Make a Call

Press the call button to dial out the predefined number or IP address.

If LED turns green, it means the call has been answered.

### 2.2. Receive a Call

Users can use phone or indoor monitor to call R26X and R26X will answer it automatically by default. If auto answer function is disabled, pressing call button to answer incoming call.

### 2.3. Unlock by RFID Card (Optional)

Place the predefined RFID card on the card reader. The door phone will announce “the door is now opened” and unlock the door.

13.56MHz RF card is supported on R26C.

## 3. Basic Features

### 3.1. Access the Website Setting

#### 3.1.1. Obtain IP Address

While R26X power up normally, hold the call button for several seconds after the statue LED turns blue and it will enter IP announcement mode. In announcement mode, the IP address will be announced periodically and “IP 0.0.0.0” would be announced if no IP address is obtained. Press call button again to quit the announcement mode.

#### 3.1.2. Access the Device Website

Open a Web browser and access the corresponding IP address. Enter the default user name and password to login. The default

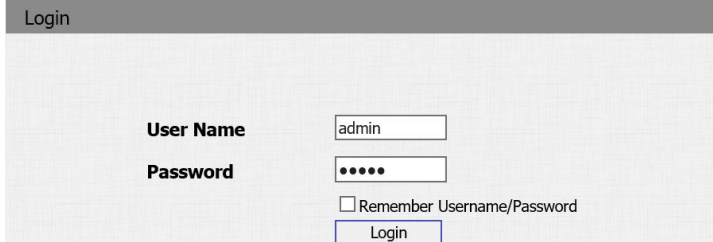

Login

User Name admin

Password .....

Remember Username/Password

Login

Figure 3.1.2 Access the device website

administrator user name and password are shown below:

User Name: **admin**

Password: **admin**

## 3.2. Password Modification

Go to **Security - Basic** to modify password and session time.

### 3.2.1. Modify the Web Password

To modify password of “admin” or “user” account.

### 3.2.2. Session Time Out

To configure session time out value. Over the value, users need to login again to continue configuring.

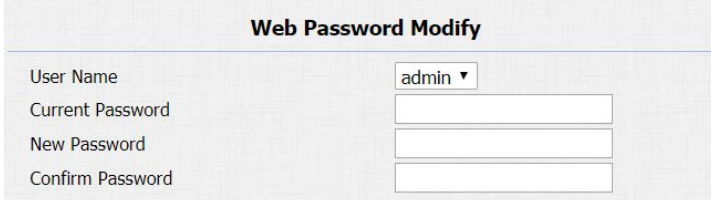

The screenshot shows a web interface titled "Web Password Modify". It contains four input fields: "User Name" with a dropdown menu showing "admin", "Current Password", "New Password", and "Confirm Password".

Figure 3.2.1 Modify the web password

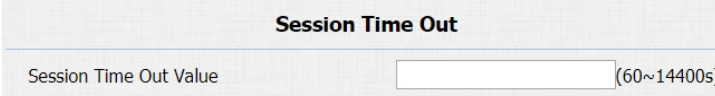

The screenshot shows a web interface titled "Session Time Out". It contains one input field labeled "Session Time Out Value" with a range indicator "(60~14400s)" to its right.

Figure 3.2.2 Session time out

## 3.3. Phone Configuration

### 3.3.1. Time/Lang

Go to **Phone - Time/Lang** to configure it.

**Time Zone:** To select local time zone for NTP server.

**Primary Server:** To configure primary NTP server address.

**Secondary Server:** To configure secondary NTP server address, it takes effect if primary NTP server is unreachable.

**Update Interval:** To configure interval between two consecutive NTP requests.

**System Time:** The current time of the phone.

### 3.3.2. Network

#### 3.3.2.1. DHCP Mode

Go to **Network - Basic**.

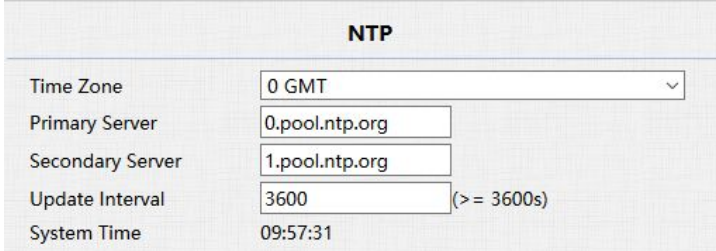

NTP	
Time Zone	0 GMT
Primary Server	0.pool.ntp.org
Secondary Server	1.pool.ntp.org
Update Interval	3600 (>= 3600s)
System Time	09:57:31

Figure 3.3.1 Time

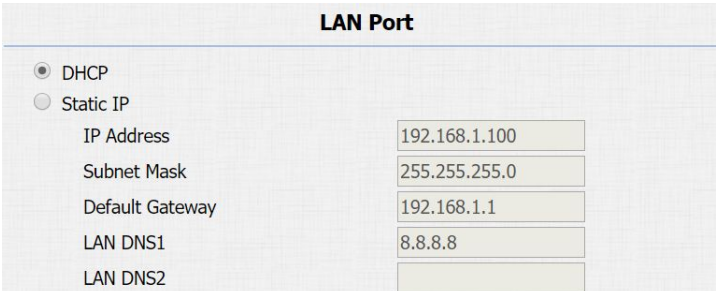

LAN Port	
<input checked="" type="radio"/> DHCP	
<input type="radio"/> Static IP	
IP Address	192.168.1.100
Subnet Mask	255.255.255.0
Default Gateway	192.168.1.1
LAN DNS1	8.8.8.8
LAN DNS2	

Figure 3.3.2.1 DHCP mode

R26X uses DHCP by default, and it will obtain IP address, subnet mask, default gateway and DNS server address from DHCP server automatically.

### 3.3.2.2. Static IP Mode

Go to **Network - Basic** to configure.

If selected, users could manually set IP address, subnet mask, default gateway and DNS server. The figure below shows static IP setting.

### 3.3.2.3. Local RTP

Go to **Network - Advanced** to configure. To display and configure Local RTP settings.

**Max RTP Port:** Determine the maximum port that RTP stream can use.

The screenshot shows the 'LAN Port' configuration page. At the top, there are two radio buttons: 'DHCP' (unselected) and 'Static IP' (selected). Below the radio buttons, there are five input fields with their corresponding values:

Field	Value
IP Address	192.168.1.100
Subnet Mask	255.255.255.0
Default Gateway	192.168.1.1
LAN DNS1	8.8.8.8
LAN DNS2	

Figure 3.3.2.2 Static IP mode

The screenshot shows the 'Local RTP' configuration page. It contains two input fields with their values and ranges:

Field	Value	Range
Starting RTP Port	11800	(1024~65535)
Max RTP Port	12000	(1024~65535)

Figure 3.3.2.3 Local RTP



**Starting RTP Port:** Determine the minimum port that RTP stream can use.

### 3.3.2.4. SNMP

Go to **Network - Advanced** to configure. To display and configure SNMP settings.

**Active:** To enable or disable SNMP feature.

**Port:** To configure SNMP server's port.

**Trusted IP:** To configure allowed SNMP server address, and it could be an IP address or any valid URL domain name.

**Note:** SNMP (Simple Network Management Protocols) is Internet-standard protocol for managing devices on IP networks.

### 3.3.2.5. VLAN

Go to **Network - Advanced** to configure. To display and configure VLAN settings.



The image shows a configuration panel titled "SNMP". It contains three rows of settings: "Active" with a dropdown menu set to "Disabled", "Port" with a text input field and a range "(1024~65535)" to its right, and "Trusted IP" with an empty text input field.

Figure 3.3.2.4 SNMP



The image shows a configuration panel titled "VLAN". It contains three rows of settings: "LAN Port" with a text input field, "Active" with a dropdown menu set to "Disabled", "VID" with a text input field containing "1" and a range "(1~4094)" to its right, and "Priority" with a dropdown menu set to "0".

Figure 3.3.2.5 VLAN

**Active:** To enable or disable VLAN feature for designated port.

**VID:** To configure VLAN ID for designated port.

**Priority:** To select VLAN priority for designated port.

**Note:** Please consult users administrator for specific VLAN settings in your networking environment.

### 3.3.2.6. TR069

Go to **Network - Advanced** to configure. To display and configure TR069 settings.

**Active:** To enable or disable TR069 feature.

**Version:** To select supported TR069 version (version 1.0 or 1.1).

**ACS/CPE:** ACS is short for auto configuration servers as server side, CPE is short for customer-premise equipment as client side devices.

**URL:** To configure URL address for ACS or CPE.

**User Name:** To configure username for ACS or CPE.

TR069		
	Active	Disabled
	Version	1.0
ACS	URL	
	User Name	
	Password	*****
Periodic Inform	Active	Disabled
	Periodic Interval	1800 (3~24x3600s)
CPE	URL	
	User Name	
	Password	*****

Figure 3.3.2.6 TR069

**Password:** To configure Password for ACS or CPE.

**Periodic Inform:** To enable periodically inform.

**Periodic Interval:** To configure interval for periodic inform.

**Note:** TR-069 (Technical Report 069) is a technical specification entitled CPE WAN Management Protocol (CWMP). It defines an application layer protocol for remote management of end-user devices.

### 3.3.3. Sound

Go to **Phone - Voice** to configure volume and upload tone file.

**Mic Volume:** To configure microphone volume.

**Speaker Volume:** To configure speaker volume.

**Open Door Warning:** Disable it, users will not hear the prompt voice when the door is opened.

Mic Volume	
Mic Volume	<input type="text" value="8"/> (1~15)

Speaker Volume	
Speaker Volume	<input type="text" value="1"/> (1~15)

Open Door Warning	
Open Door Warning	<input type="text" value="Enabled"/>

IP Announcement	
IP Announcement active time	<input type="text" value="0"/> (0~180)

Figure 3.3.3-1 Sound

**IP Announcement:** To setup the IP announcement active time. Over the configured value, the phone will not announce the IP when users hold the button.

**RingBack Upload:** To upload the ring back tone by users.

**Opendoor Tone Upload:** To upload the opendoor tone by users.

## 3.4. Intercom Call

### 3.4.1. Direct IP Call

Without sip server, users can also use IP address to call each other, but this way is only suitable in the LAN.

Go to **Phone - Call Feature** to enable the direct IP call for door phones first.

Then, go to **Intercom - Basic** to configure the IP address of the destination(E.g. IP address 192.168.1.100). It supports up to 8 lines simultaneously.

The image shows two sections of a web interface. The top section is titled "RingBack Upload" and contains a "Choose File" button, the text "No file chosen", and "Upload" and "Delete" buttons. Below this is the text "File Format: wav, size: < 200KB, samplerate: 16000, Bits: 16". The bottom section is titled "Opendoor Tone Upload" and contains the same "Choose File" button, "No file chosen" text, and "Upload" and "Delete" buttons, with the same file format information below.

Figure 3.3.3-2 Sound

The image shows a single line of a web interface with the text "Direct IP" on the left and a dropdown menu on the right showing "Enabled" with a downward arrow.

Figure 3.4.1-1 Direct IP call

Push Button				
Key	Number	Number2	Number3	Number4
Push Button	192.168.35.26			

Figure 3.4.1.1 Push button

After all, press the push button to make direct IP call.

If you would like to call multiple numbers at the same time, divide them by semicolon.

**Note:** The push button number can also enter the SIP account.

## 3.4.2. SIP Call

SIP calls which use SIP numbers to make or receive calls should be supported by SIP server. Users need to register accounts and fill SIP feature parameters before using it.

Go to **Account - Basic** to configure SIP account and SIP server for door phone first. Then press the push button to make SIP call.

### 3.4.2.1. SIP Account

**Status:** To display register result.

**Display Label:** To configure label displayed on the phone's LCD screen.



SIP Account	
Status	Registered
Account	Account 1
Account Active	Enabled
Display Label	R26
Display Name	Door_R26
Register Name	9003
User Name	9003
Password	.....

Figure 3.4.2.1 SIP account

**Display Name:** To configure name sent to the other call party for displaying.

**Register Name:** To enter extension number you want and the number is allocated by SIP server.

**User Name:** To enter user name of the extension.

**Password:** To enter password for the extension.

### 3.4.2.2. SIP Server 1&2

**Server IP 1:** To enter SIP server's IP address or URL.

**Server IP 2:** To display and configure secondary SIP server settings.

This is for redundancy, if registering to primary SIP server fails, the phone will go to secondary SIP server for registering.

**Registration Period:** The registration will expire after registration period, the phone will re-register automatically within registration period.

SIP Server 1		
Server IP	<input type="text" value="120.78.230.239"/>	Port <input type="text" value="5070"/>
Registration Period	<input type="text" value="1800"/>	(30~65535s)

Figure 3.4.2.2-1 SIP server 1&2

SIP Server 2		
Server IP	<input type="text"/>	Port <input type="text" value="5060"/>
Registration Period	<input type="text" value="1800"/>	(30~65535s)

Figure 3.4.2.2-2 SIP server 1&2

### 3.4.2.3. Outbound Proxy Server

An outbound proxy server is used to receive all initiating request messages and route them to the designated SIP server.

### 3.4.2.4. Transport Type

To display and configure transport type for SIP message.

- UDP: UDP is an unreliable but very efficient transport layer protocol.
- TCP: Reliable but less-efficient transport layer protocol.
- TLS: Secured and reliable transport layer protocol.
- DNS-SRV: DNS record for specifying the location of services.

### 3.4.2.5. NAT

To display and configure NAT (Net Address Translator) settings.

- STUN: Short for simple traversal of UDP over NATs, a solution to solve NAT issues.

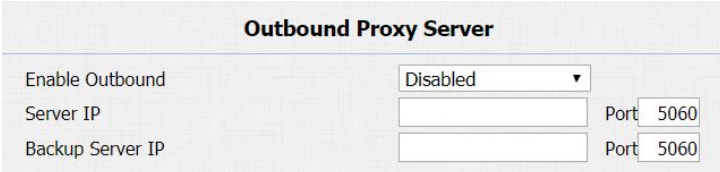

The screenshot shows the 'Outbound Proxy Server' configuration panel. It includes a dropdown menu for 'Enable Outbound' set to 'Disabled', and two rows for 'Server IP' and 'Backup Server IP', each with a text input field and a 'Port' field set to '5060'.

Figure 3.4.2.3 Outbound proxy server

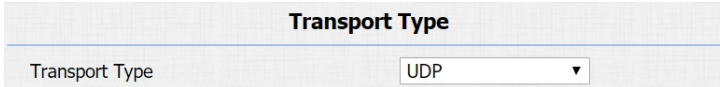

The screenshot shows the 'Transport Type' configuration panel with a single dropdown menu set to 'UDP'.

Figure 3.4.2.4 Transport type



The screenshot shows the 'NAT' configuration panel. It includes a dropdown menu for 'NAT' set to 'Disabled', and a row for 'Stun Server Address' with a text input field and a 'Port' field set to '3478'.

Figure 3.4.2.5 NAT

**Note:** By default, NAT is disabled.

### 3.4.3. Auto Answer

Go to **Account - Advanced** to enable auto answer feature for SIP call.

Go to **Phone - Call Feature** to enable auto answer feature for direct IP call without SIP proxy.

**Auto Answer Delay:** To configure delay time before an incoming call is automatically answered.

**Auto Answer Mode:** To set video or audio mode for auto answer by default.

Then incoming call will be answered automatically.

### 3.4.4. Web Call

Go to **Intercom - Basic** to dial out or answer incoming call from website.



Auto Answer Enabled ▾

Figure 3.4.3-1 Auto answer



Direct IP AutoAnswer Enabled ▾

Figure 3.4.3-2 Auto answer

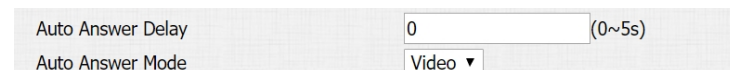

Auto Answer Delay 0 (0~5s)  
Auto Answer Mode Video ▾

Figure 3.4.3-3 Auto answer

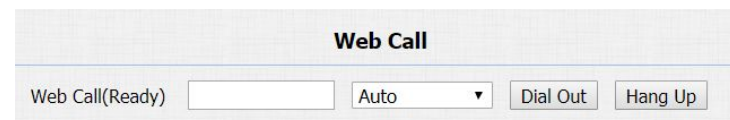

**Web Call**  
Web Call(Ready)  Auto ▾ Dial Out Hang Up

Figure 3.4.4 Web call



### 3.4.5. No Answer Call

Go to **Intercom - Basic** and enable the no answer call.

Go to **Intercom - Basic** and set the no answer call number.

No Answer Call

Figure 3.4.5-1 No Answer call

No Answer Call1

No Answer Call2

Figure 3.4.5-2 No answer call

### 3.4.6. Multicast

Go to **Intercom - Multicast** to configure.

**Paging Barge:** Choose the multicast number, the range is 1-10.

**Paging priority Active:** Enable to disable the multicast.

**Listening Address:** Enter the IP address users need to listen.

**Label:** Input the label for each listening address.

**Multicast Setting**

Paging Barge

Paging Priority Active

**Priority List**

IP Address	Listening Address	Label	Priority
1 IP Address	<input type="text" value="224.1.6.11:1200"/>	<input type="text" value="Test"/>	1
2 IP Address	<input type="text"/>	<input type="text"/>	2
3 IP Address	<input type="text"/>	<input type="text"/>	3
4 IP Address	<input type="text"/>	<input type="text"/>	4

Figure 3.4.6 Multicast

### 3.4.7. Push To Hang Up

Go to **Intercom - Basic** to configure. To enable or disable pushing button to hang up.

Push To Hang Up

Figure 3.4.7 Push to hang up

## 3.5. Security

### 3.5.1. Live View

Go to **Intercom - Live Stream** to check the real-time video from R26X. In addition, users also can check the real-time picture via URL: **http://IP\_address:8080/picture.jpg**

Users can also check the real-time video via URL: **http://IP\_address:8080/video.cgi**

**PelcoController:** The R26X doorphone can support the pelco-d protocol and control the direction of camera cradle head.

### 3.5.2. RTSP

R26X supports RTSP stream, go to **Intercom - RTSP** to enable or disable RTSP server. The URL for RTSP stream is:



Figure 3.5.1 Live view

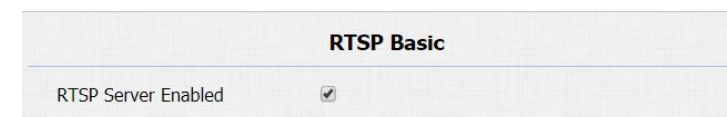

Figure 3.5.2-1 RTSP

**rtsp://IP\_address/live/ch00\_0.**

**RTSP Stream:** To enable RTSP video and select the video codec.

R26X supports H.264 video codec.

**H.264 Video Parameters:** H.264 is a video stream compression standard. Different from H.263, it provides an approximately identical level of video stream quality but a half bit rate. This type of compression is sometimes called MPEG-4 part 10.

To modify the resolution, framerate and bitrate of H.264.

**MPEG4 Video Parameters:** MPEG4 is one of the network video image compression standard. It supports the maximum compression ratio 4000:1. It is an important and common video function with great communication application integration ability and less core program space. To modify the resolution, framerate and bitrate of MPEG4.

**MJPEG Video Parameters:** Called motion joint photographic experts group. It is a video encoding format, in which each image is

RTSP Stream	
RTSP Video Enabled	<input checked="" type="checkbox"/>
RTSP Video Codec	H.264

H.264 Video Parameters	
Video Resolution	VGA
Video Framerate	30 fps
Video Bitrate	256 kbps

MPEG4 Video Parameters	
Video Resolution	VGA
Video Framerate	30 fps
Video Bitrate	2048 kbps

MJPEG Video Parameters	
Video Resolution	VGA
Video Framerate	30 fps
Video Quality	90

Figure 3.5.2-2 RTSP

compressed separately by JPEG. MJPEG compression can produce high quality video image and has a flexible configuration in video definition and compressed frames.

To modify the resolution, framerate and bitrate of MJPEG.

### 3.5.3. ONVIF

R26X supports ONVIF protocol, which means R26X's camera can be searched by other devices, like NVR, which supports ONVIF protocol as well.

Go to **Intercom - ONVIF** to configure ONVIF mode and its username/password.

Switching ONVIF mode to undiscoverable means that users must program ONVIF's URL manually.

The ONVIF's URL is:

**`http://IP_address:8090/onvif/device_service`**

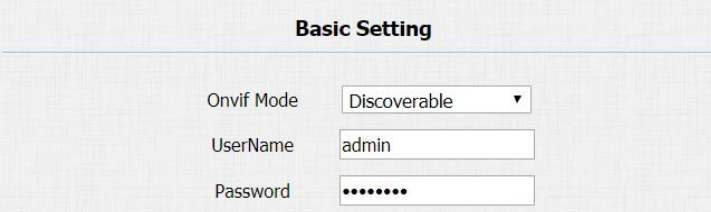

The screenshot shows a web interface titled "Basic Setting". It contains three configuration fields: "Onvif Mode" with a dropdown menu set to "Discoverable", "UserName" with a text input field containing "admin", and "Password" with a text input field containing seven dots.

Figure 3.5.3 ONVIF

## 3.6. Access Control

### 3.6.1. Relay

Go to **Intercom - Relay** to configure relay.

There are three terminals of relay: NO, NC and COM. NO stands for normally open contact while NC stands for normally closed contact.

**Relay ID:** R26X supports two relays, users can configure them respectively.

**Relay Type:** Default state means NC and COM are normally closed, while invert state means NC and COM are normally opened.

**Relay Delay:** To configure the duration of opened relay. Over the value, the relay would be closed again.

**DTMF Option:** To select digit of DTMF code, R26X supports maximum 4 digits DTMF code.

**DTMF:** To configure 1 digit DTMF code for remote unlock.

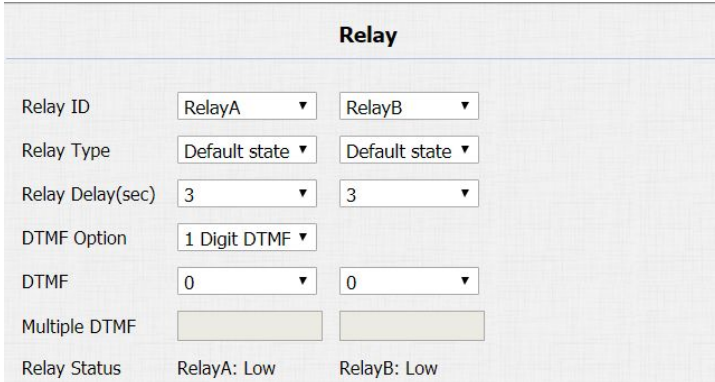

Relay		
Relay ID	RelayA ▼	RelayB ▼
Relay Type	Default state ▼	Default state ▼
Relay Delay(sec)	3 ▼	3 ▼
DTMF Option	1 Digit DTMF ▼	
DTMF	0 ▼	0 ▼
Multiple DTMF	<input type="checkbox"/>	
Relay Status	RelayA: Low	RelayB: Low

Figure 3.6.1 Relay

**Multiple DTMF:** To configure multiple digits DTMF code for remote unlock.

**Relay Status:** Low means that COM is connecting to NC while High means that COM is connecting to NO.

**Note:** Relay operate a switch and does not deliver power, so users should prepare power adapter for external devices which connects to relay.

### 3.6.2. Card Setting (Optional)

Go to **Intercom - Card setting**, to manage card access system.

#### Import/Export Card Data

R26X supports import or export the card data file, which is convenient for administrator to deal with a large number of cards.

The maximum card data file is 200K which is around 500 cards.

**Note:** Please consult administrator for the template RFID cards data file.



Figure 3.6.2-1 Card setting

### Obtain and Add Card

- Switch card status to “Card Issuing” and click “Apply”;
- Place card on the card reader area and click “Obtain”;
- Name card, choose which door you want to open and the valid day and time;
- Click “Add” to add it into list.

**Note:** Users can use card to access only when card status has been switched to “Normal”.

### Door Card Management

Valid card information will be shown in the list. Administrator could delete one card’s access permission or empty all the list.

### 3.6.3. Open Relay via HTTP

Users can use a URL to remote unlock the door.

Go to **Intercom - Relay** to configure.

**Switch:** Enable this function. Disable by default.

**Card Setting**

IC Key DoorNum RelayA  RelayB  RelayC

IC Key Day Mon  Tue  Wed  Thur   
Fri  Sat  Sun  Check All

IC Key Time 06 : 00 - 12 : 00

IC Key Name Courier

IC Key Code FFB59828

Obtain Add

Figure 3.6.2-2 Card setting

**Door Card Management**

Index	Name	Code	Door	
1				<input type="checkbox"/>
2				<input type="checkbox"/>
3				<input type="checkbox"/>
4				<input type="checkbox"/>
5				<input type="checkbox"/>
6				<input type="checkbox"/>
7				<input type="checkbox"/>
8				<input type="checkbox"/>
9				<input type="checkbox"/>
10				<input type="checkbox"/>

Page 1 Prev Next Delete Delete All

Figure 3.6.2-3 Card setting

**UserName & Password:** Users can setup the username and password for HTTP unlock.

**URL format:**

**http://IP\_address/fcgi/do?action=OpenDoor&UserName=&Password=&DoorNum=1**

### 3.6.4. Unlock via Exit Button

Go to **Intercom - Input** to configure input settings.

R26X supports two input triggers Input A/B (DOOR A/B).

**Input Service:** To enable or disable input trigger service.

**Trigger Option:** To choose open circuit trigger or closed circuit trigger. Low means that connection between door terminal and GND is closed, while high means the connection is opened.

**Action to execute:** To choose which action to execute after the input terminal is triggered.

**Http URL:** To configure URL, If HTTP action is chosen.

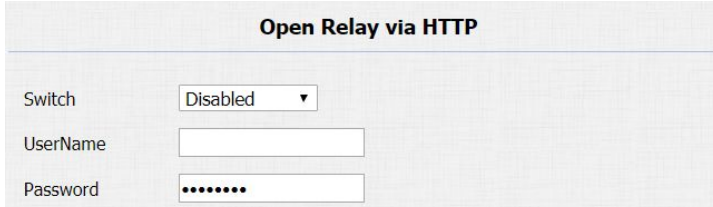

**Open Relay via HTTP**

Switch: Disabled

UserName: [Empty]

Password: [Masked]

Figure 3.6.3 Open relay via HTTP

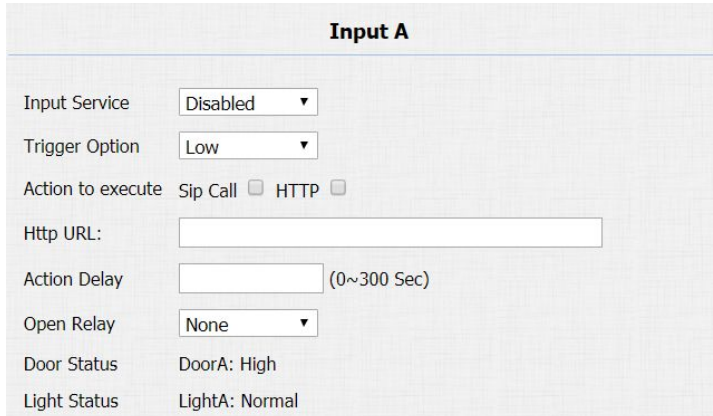

**Input A**

Input Service: Disabled

Trigger Option: Low

Action to execute: Sip Call  HTTP

Http URL: [Empty]

Action Delay: [Empty] (0~300 Sec)

Open Relay: None

Door Status: DoorA: High

Light Status: LightA: Normal

Figure 3.6.4-1 Unlock via exit button



**Open Relay:** To configure relay to open.

**Door Status:** To show the status of input signal.

## 3.7. Reboot

Go to **Upgrade - Basic**, users can reboot the phone.



Figure 3.7 Reboot

## 3.8. Reset

Go to **Upgrade - Basic**, users can reset to factory setting.



Figure 3.8 Reset

# 4. Advance Feature

## 4.1. Phone Configuration

### 4.1.1. LED

Go to **Intercom - LED Setting** to configure the LED status.

To setup the LED lighting mode.

**State:** There is five states: Normal, Offline, Calling, Talking and Receiving.

**Color Off:** The default status is OFF.

**Color On:** It can support three color: Red, Green, Blue.

**Blink Mode:** To setup the different blink frequency.

#### LED Control:

Use HTTP URL to remote control the LED status.

#### Http format:

**http://PhoneIP/fcgi/do?action=LedAction&State=1&Color=1&Mode=2500**

**Status: 1=Idle; 2=OffLine; 3=Calling; 4=Talking; 5=Receiving;**

**Color: 1=Green; 2=Blue; 3=Red; Mode: 0=Always On; 1=Always**

**Off; 500/1000/1500/2000/25000/3000**

LED Status			
State	Color Off	Color On	Blink Mode
NORMAL	OFF	Blue	Always On
OFFLINE	OFF	Red	2500/2500
CALLING	OFF	Blue	2500/2500
TALKING	OFF	Green	Always On
RECEIVING	OFF	Green	2500/2500

Figure 4.1.1-1 LED

LED Control	
LED Control	Disabled

Figure 4.1.1-2 LED

## 4.1.2. IR LED

Go to **Intercom - Advanced** to configure.

**Photoresistor:** The setting is for night vision, when the surrounding of R26X is very dark, infrared LED will turn on and R26X will turn to night mode. Photoresistor value relates to light intensity and larger value means that light intensity is smaller. Users can configure the upper and lower bound and when photoresistor value is larger than upper bound, infrared LED will turn on. As contrast, when photoresistor value is smaller than lower bound, infrared LED will turn off and device turns to normal mode.



Photoresistor	
Photoresistor Setting	<input type="text" value="15"/> - <input type="text" value="30"/> (0~100)

Figure 4.1.2 IR LED

## 4.1.3. RF Card Code Display Related

Go to **Intercom - Advanced** to configure.

**RFID Display Mode:** To be compatible different card number formats. The default 8HN means hexadecimal.



RFID	
RFID Display Mode	<input type="text" value="8HN"/>

Figure 4.1.3 RF card code display related

## 4.2. Intercom

### 4.2.1. Call Time Related

Go to **Intercom - Basic** to configure.

**Max Call Time:** To configure the max call time.

**Dial In Time:** To configure the max incoming dial time, available when auto answer is disabled.

**Dial Out Time:** To configure the max no answer call time.

**Hang Up After Open Door:** To set the time that hang up the call after open the door.

### 4.2.2. Return Code When Refuse

Go to **Phone - Call Feature - Others** to configure.

**Return Code When Refuse:** Allows users to assign specific code as return code to SIP server when an incoming call is rejected.

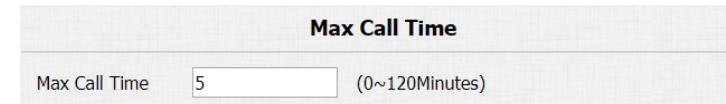

The screenshot shows a configuration panel titled "Max Call Time". It contains a single input field labeled "Max Call Time" with the value "5" entered. To the right of the input field, the range "(0~120Minutes)" is displayed.

Figure 4.2.1-1 Call time related

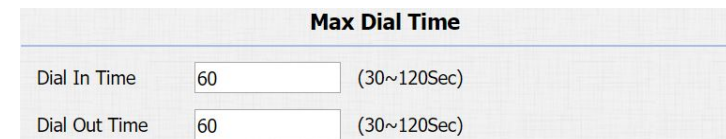

The screenshot shows a configuration panel titled "Max Dial Time". It contains two input fields. The first is labeled "Dial In Time" with the value "60" and the range "(30~120Sec)" to its right. The second is labeled "Dial Out Time" with the value "60" and the range "(30~120Sec)" to its right.

Figure 4.2.1-2 Call time related



The screenshot shows a configuration panel titled "Hang Up After Open Door". It contains a single input field labeled "Time Out" with the value "5" entered. To the right of the input field, the range "(0~15)" is displayed.

Figure 3.4.8 Hang up after open door



The screenshot shows a configuration panel titled "Return Code When Refuse". It contains a dropdown menu with the value "486(Busy Here)" selected.

Figure 4.2.2 Return code when refuse

### 4.2.3. SIP Call Related

Go to **Account-Advanced** to configure the SIP call related.

**Max Local SIP Port:** To configure maximum local SIP port for designated SIP account.

**Min Local SIP Port:** To configure maximum local SIP port for designated SIP account.

**Caller ID Header:** To choose caller ID header format.

**Anonymous Call:** If enabled, R26X will block its information when calling out.

**Anonymous Call Rejection:** If enabled, calls who block their information will be screened out.

**Missed Call Log:** If enabled, any missed call will be recorded into call log.

**Prevent Hacking:** If enabled, it will prevent SIP messages from hacking.

Call	
Max Local SIP Port	5062 (1024~65535)
Min Local SIP Port	5062 (1024~65535)
Caller ID Header	RPID-FROM
Auto Answer	Enabled
Anonymous Call	Disabled
Anonymous Call Rejection	Disabled
Missed Call Log	Enabled
Prevent SIP Hacking	Disabled

Figure 4.2.3-1 SIP call related

SIP Account	
Account	Account 1

Figure 4.2.3-2 SIP call related

### 4.2.4. Codec

Go to **Account - Advanced** to configure SIP call related codec.

**SIP Account:** To choose which account to configure.

**Audio Codec:** R26X support four audio codec: PCMA, PCMU, G729, G722. Different audio codec requires different bandwidth, users can enable/disable them according to different network environment.

**Note:** Bandwidth consumption and sample rates are as below:

Codec	Bandwidth	Sample Rates
PCMA	64kbit/s	8kHz
PCMU	64kbit/s	8kHz
G729	8kbit/s	8kHz
G722	64kbit/s	16kHz

**Video Codec:** R26X supports H.264 standard, which provides better video quality at substantially lower bit rates than previous

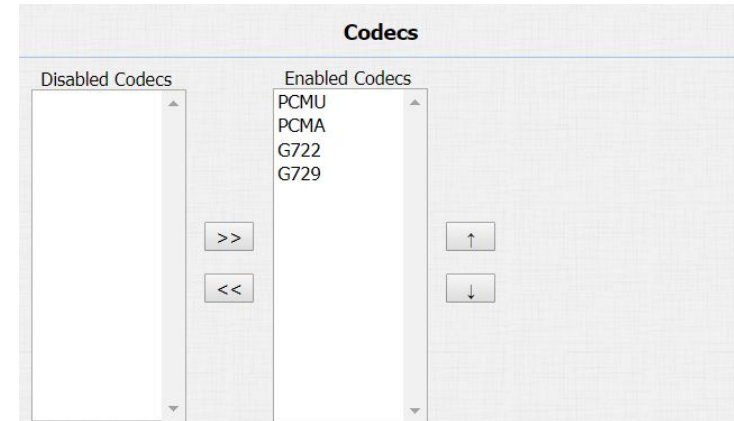

Figure 4.2.4-1 Codec

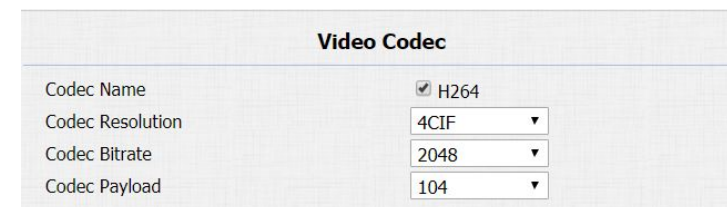

Figure 4.2.4-2 Codec

standards.

**Codec Resolution:** R26X supports four resolutions: QCIF, CIF, VGA, 4CIF and 720P.

**Codec Bitrate:** To configure bit rates of video stream.

**Codec Payload:** To configure RTP audio video profile.

Go to **Phone - Call Feature** to configure multicast related codec.

## 4.2.5. DTMF

Go to **Account - Advanced** to configure RTP audio video profile for DTMF and its payload type.

**Type:** Support Inband, Info, RFC2833 or their combination.

**How To Notify DTMF:** Only available when DTMF type is Info.

**DTMF Payload:** To configure payload type for DTMF.



Multicast Codec PCMU ▼

Figure 4.2.4-3 Codec

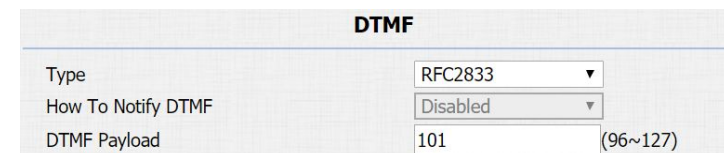

DTMF	
Type	RFC2833 ▼
How To Notify DTMF	Disabled ▼
DTMF Payload	101 (96~127)

Figure 4.2.5 DTMF

## 4.2.6. Session Timer

Go to **Account - Advanced** to configure it.

If enabled, the on going call will be disconnected automatically once the session expired unless it's been refreshed by UAC or UAS.

## 4.2.7. Encryption

Go to **Account - Advanced** to configure it.

If enabled, voice will be encrypted.

## 4.2.8. NAT

Go to **Account - Advanced** to display NAT related settings.

**UDP Keep Alive message:** If enabled, R26X will send UDP keep-alive message periodically to router to keep NAT port alive.

**UDP Alive Msg Interval:** Keep alive message interval.

Session Timer	
Active	Disabled
Session Expire	1800 (90~7200s)

Figure 4.2.6 Session timer

Encryption	
Voice Encryption(SRTP)	Disabled

Figure 4.2.7 Encryption

NAT	
UDP Keep Alive Messages	Disabled
UDP Alive Msg Interval	30 (5~60s)
RPort	Disabled

Figure 4.2.8 NAT



**Rport:** Remote Port, if enabled, it will add remote port into outgoing SIP message for designated account.

## 4.2.9. User Agent

Go to **Account - Advanced** to configure it.

To customize user agent field in the SIP message.

If users agent is set to specific value, users could see the information from network package. If user agent is not set by default, users could see the company name, model number and firmware version from network package.

## 4.3. Access Control

### 4.3.1. Web Relay

R26X can support extra web relay which is connected with the door phone via network.

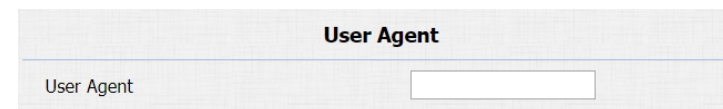

The screenshot shows a configuration form titled "User Agent". It contains a single text input field labeled "User Agent".

Figure 4.2.9 User agent

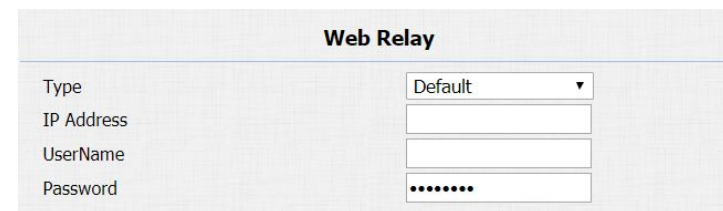

The screenshot shows a configuration form titled "Web Relay". It contains four fields: "Type" with a dropdown menu set to "Default", "IP Address" with a text input field, "UserName" with a text input field, and "Password" with a password input field (masked with dots).

Figure 4.3.1-1 Web relay

Go to **Phone - WebRelay** to configure.

**Type:** Connect web relay and choose the type.

**IP Address:** Enter web relay's IP address.

**UserName:** It is an authentication for connecting web relay.

**Password:** It is an authentication for connecting web relay.

**Web Relay Action:** Web relay action is used to trigger the web relay.

The action URL is provided by web relay vendor.

**Web Relay Key:** If the DTMF keys same as the local relay, the web relay will be open with local relay. But if there are different, the web relay is invalid.

**Web Relay Extension:** The webrelay can only receive the DTMF signal from the corresponding extension number.

**Note:** Users can modify username and password in web relay website.

Action ID	Web Relay Action	Web Relay Key	Web Relay Extension
Action ID 01	state.xml?relayState=2	1	192.168.1.99
Action ID 02			
Action ID 03			
Action ID 04			
Action ID 05			
Action ID 06			
Action ID 07			
Action ID 08			
Action ID 09			
Action ID 10			

Submit Cancel

Figure 4.3.1-2 Web relay

## 4.4. Security

### 4.4.1. Anti-alarm

Go to **Intercom - Advanced** to configure.

R26X integrates internal gravity sensor for the own security, and after enabling tamper alarm, if the gravity of R26X changes dramatically, the phone will alarm. Gravity sensor threshold stands for sensitivity of sensor.

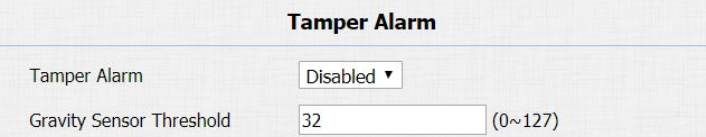

The screenshot shows a configuration panel titled "Tamper Alarm". It contains two settings: "Tamper Alarm" is set to "Disabled" via a dropdown menu, and "Gravity Sensor Threshold" is set to "32" in a text input field, with a range of "(0~127)" indicated to the right.

Figure 4.4.1 Anti-alarm

### 4.4.2. Motion

R26X supports motion detection, go to **Intercom - Motion** to configure detection parameter.

**Motion Detection:** To enable or disable motion detection

**Motion Delay:** To configure minium time gap between two snapshots.



The screenshot shows a configuration panel titled "Motion Detection Options". It contains two settings: "Motion Detection" is set to "Disabled" via a dropdown menu, and "Motion Delay" is set to "10" in a text input field, with a range of "(0~120 Sec)" indicated to the right.

Figure 4.4.2-1 Motion

**Motion Detect Time Setting:** To make motion detect time for a whole week.

### 4.4.3. Action

R26X supports to send notifications, snapshots via email and ftp transfer method, or calls via SIP call method, when trigger specific actions.

#### 4.4.3.1. Action Parameters

Go to **Intercom - Action** to set action receiver.

##### Email Notification

**Sender's email address:** To configure email address of sender.

**Receiver's email address:** To configure email address of receiver.

**SMTP server address:** To configure SMTP server address of sender.

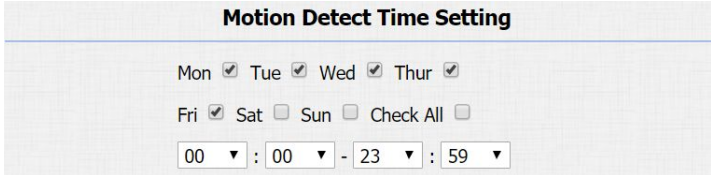

The screenshot shows the 'Motion Detect Time Setting' interface. It features a header 'Motion Detect Time Setting' and a grid of checkboxes for days of the week: Mon, Tue, Wed, and Thur are checked, while Fri, Sat, and Sun are unchecked. There is also a 'Check All' checkbox which is unchecked. Below the checkboxes, there are four dropdown menus for time selection: the first is set to '00', the second to '00', the third to '23', and the fourth to '59', separated by colons and a hyphen.

Figure 4.4.2-2 Motion

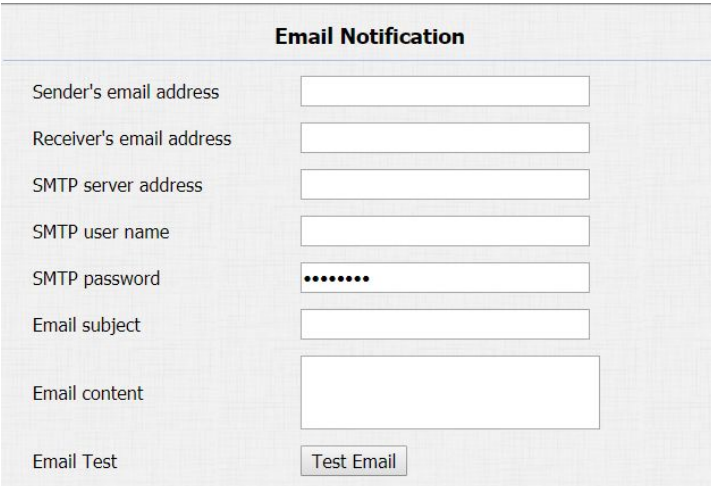

The screenshot shows the 'Email Notification' configuration interface. It has a header 'Email Notification' and several input fields: 'Sender's email address', 'Receiver's email address', 'SMTP server address', 'SMTP user name', 'SMTP password' (masked with dots), and 'Email subject'. Below these is a larger text area for 'Email content'. At the bottom, there is an 'Email Test' label and a 'Test Email' button.

Figure 4.4.3.1-1 Action parameters

**SMTP user name:** To configure user name of SMTP service (usually it is same with sender's email address).

**SMTP password:** To configure password of SMTP service (usually it is same with the password of sender's email).

**Email subject:** To configure subject of email.

**Email content:** To configure content of email.

**Email Test:** To test whether email notification is available.

#### **FTP Notification**

**FTP Server:** To configure URL of FTP server.

**FTP User Name:** To configure user name of FTP server.

**FTP Password:** To configure password of FTP server.

**FTP Test:** To test whether FTP notification is available.

#### **SIP Notification**

**SIP Call Number:** To configure SIP call number.

**SIP Call Name:** To configure display name of R26X.

The screenshot displays a configuration interface with two sections: 'FTP Notification' and 'SIP Call Notification'. The 'FTP Notification' section includes fields for 'FTP Server', 'FTP User Name', and 'FTP Password' (masked with dots), along with a 'Test FTP' button. The 'SIP Call Notification' section includes fields for 'SIP Call Number' and 'SIP Caller Name'.

FTP Notification	
FTP Server	<input type="text"/>
FTP User Name	<input type="text"/>
FTP Password	<input type="password"/>
FTP Test	<input type="button" value="Test FTP"/>

SIP Call Notification	
SIP Call Number	<input type="text"/>
SIP Caller Name	<input type="text"/>

Figure 4.4.3.1-2 Action parameters

### 4.4.3.2. No Answer Action

Go to **Intercom - Basic** to configure.

**No Answer Action:** For sending the notification to specified email if the call is not answered.



Figure 4.4.3.2 No answer action

### 4.4.3.3. Push Button Action

Go to **Intercom - Basic** to configure.

Enable this function, the device will record any changes of the surrounding environment then send the message or picture to the corresponding receiver.

**Action to execute:** Tick the suit the suitable way to receive the action message.

**HTTP URL:** If you tick HTTP URL, and then enter the HTTP server IP address in the HTTP URL area. When the device detects any changes, it will send HTTP network package.

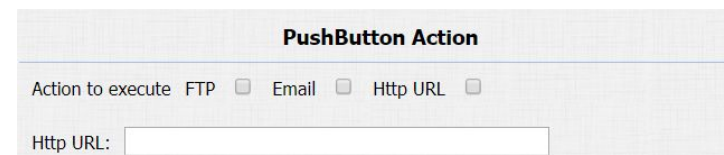

Figure 4.4.3.3 PushButton action

#### 4.4.3.4. Input Interface Triggered Action

Go to **Intercom - Input** to configure.

**Action to execute:** To choose which action to execute after triggering.

**Http URL:** To configure URL, If HTTP action is chosen.

**Action Delay:** To configure after how long to execute to send out notifications and trigger relay.

**Open Relay:** To configure which relay to trigger.

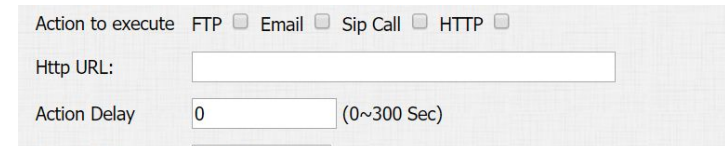

The screenshot shows a configuration form for the 'Input Interface Triggered Action'. It includes a section for 'Action to execute' with radio buttons for FTP, Email, Sip Call, and HTTP. Below this is a text input field for 'Http URL:' and a numeric input field for 'Action Delay' set to 0, with a range of (0~300 Sec) indicated.

Figure 4.4.3.4 Input interface trigger action

#### 4.4.3.5. Motion Triggered Action

Go to **Intercom - Motion** to configure.

**Action to execute:** To choose which action to execute after triggering.

**Http URL:** To configure URL, If HTTP action is chosen.

**SDMC Upload:** Upload the capture to the SDMC.

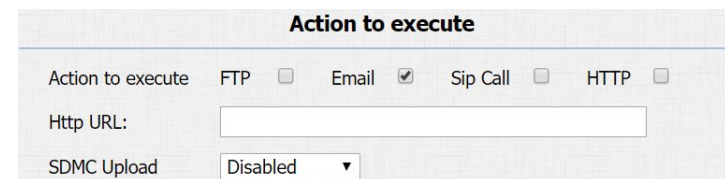

The screenshot shows a configuration form for the 'Motion Triggered Action'. It features a title 'Action to execute' and a section with radio buttons for FTP, Email (which is selected), Sip Call, and HTTP. Below this is a text input field for 'Http URL:' and a dropdown menu for 'SDMC Upload' currently set to 'Disabled'.

Figure 4.4.3.5 Motion trigger action

### 4.4.3.6. Action URL

Action URL can be triggered by some predefined incidents.

Go to **Phone - Action URL**, pick **Active** to be “Enabled”, pick to demand triggered incident, each “HTTP” request to have to including the key and value, use “=” to separate, each value starting with “\$.” For example, “**Open Relay Success**” incident, input **http://server IP address/help.xml?mac=\$mac**, when the relay of R26X is triggered successfully, the phone will send a HTTP packet to the server, through the HTTP package to know the MAC of the phone.

## 4.5. Upgrade

### 4.5.1. Web Upgrade

Go to **Upgrade - Basic**, users can upgrade firmware. Reset to factory setting and reboot.

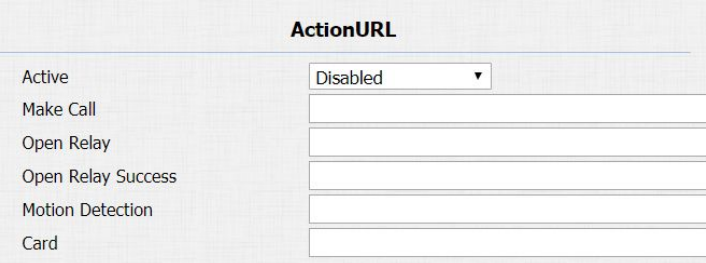

ActionURL	
Active	Disabled ▼
Make Call	<input type="text"/>
Open Relay	<input type="text"/>
Open Relay Success	<input type="text"/>
Motion Detection	<input type="text"/>
Card	<input type="text"/>

Figure 4.4.3.6 Action URL

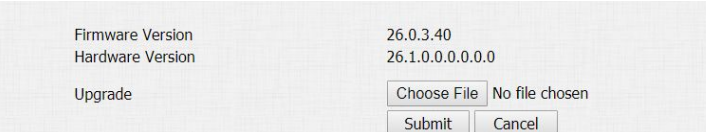

Firmware Version	26.0.3.40
Hardware Version	26.1.0.0.0.0.0.0
Upgrade	<input type="button" value="Choose File"/> No file chosen <input type="button" value="Submit"/> <input type="button" value="Cancel"/>

Figure 4.5.1 Web update



**Upgrade:** Choose .rom firmware from the PC, and then click **Submit** to start update.

## 4.5.2. Autop Upgrade

Go to **Upgrade - Advanced** to configure automatically update server's settings.

### PNP Option

Plug and Play, once PNP is enabled, the phone will send SIP subscription message to PNP server automatically to get auto provisioning server's address.

By default, this SIP message is sent to multicast address 224.0.1.75 (PNP server address by standard).

### Manual Autop

Autop (Auto-Provisioning) is a centralized and unified upgrade of telephone. It is a simple and time-saving configuration for phone. It is mainly used by the device to download corresponding

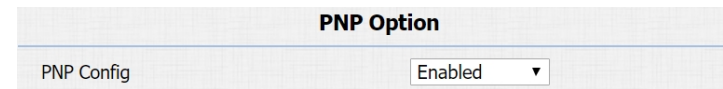

The screenshot shows a configuration panel titled "PNP Option". Below the title, there is a label "PNP Config" followed by a dropdown menu currently set to "Enabled".

Figure 4.5.2-1 Autop update

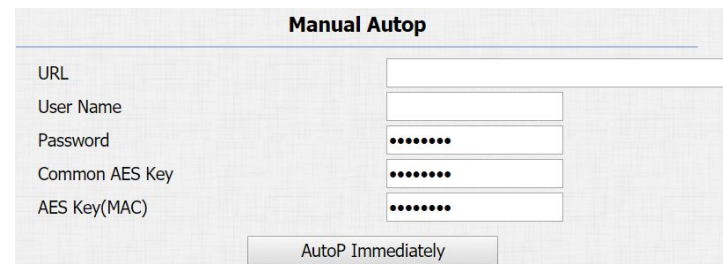

The screenshot shows a configuration panel titled "Manual Autop". It contains several input fields: "URL", "User Name", "Password" (masked with dots), "Common AES Key" (masked with dots), and "AES Key(MAC)" (masked with dots). At the bottom of the panel is a button labeled "AutoP Immediately".

Figure 4.5.2-2 Autop update

configuration document from the server using TFTP / FTP / HTTP / HTTPS network protocol. To achieve the purpose of updating the device configuration, making the users to change the phone configuration more easily. This is a typical C/S architecture upgrade mode, mainly by the terminal device or PBX server to initiate an upgrade request.

**URL:** Auto provisioning server address.

**User Name:** Configure if server needs an username to access, otherwise left blank.

**Password:** Configure if server needs a password to access, otherwise left blank.

**Common AES Key:** Used for phone to decipher common auto provisioning configuration file.

**AES Key (MAC):** Used for phone to decipher MAC-oriented auto provisioning configuration file (for example, file name could be 0C1105888888.cfg if phone's MAC address is 0C1105888888).

**Note:** AES is one of many encryption, it should be configured only when configure file is ciphered with AES, otherwise left blank.

### Automatic Autop

To display and configure auto provisioning mode settings.

This auto provisioning mode is actually self-explanatory.

For example, mode "Power on" means phone will go to do provisioning every time it powers on.

**Note:** Please refer to the related feature guide from Akuvox forum.

## 4.5.3. Backup Config File

Go to **Upgrade - Advanced** to backup the config file.

**Export Autop Template:** To export current config file.

**Others:** To export current config file (Encrypted) or import new config file.

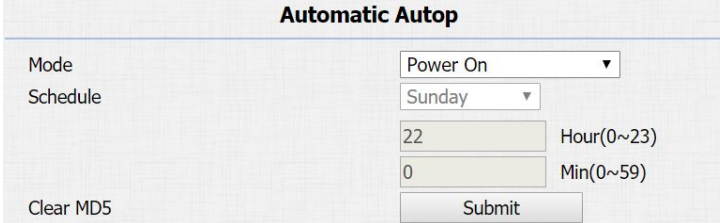

**Automatic Autop**

Mode	Power On
Schedule	Sunday
	22 Hour(0~23)
	0 Min(0~59)
Clear MD5	<input type="checkbox"/>
	<input type="button" value="Submit"/>

Figure 4.5.2-3 Autop update



Export Autop Template

Figure 4.5.3-1 Backup config file



**Others**

Config File(.tgz/.conf/.cfg)	<input type="button" value="Choose File"/>	No file chosen
	<input type="button" value="Export"/>	(Encrypted)
	<input type="button" value="Import"/>	<input type="button" value="Cancel"/>

Figure 4.5.3-2 Backup config file

### 4.5.4. DHCP Option

To display and configure DHCP setting for AutoP. Option 66/43 is enable by default. It can support HTTPS, HTTP, FTP, TFTP server.

**Customer Option:** Enter the server URL. Click “Submit” to save.

**Note:** To make DHCP autop URL works, the PNP should be disable.

Figure 4.5.4 Backup confia file

Index	Type	Date	Time	Local Identity	Name	Number	
1	Received	2018-09-30	08:28:46	192.168.35.1 0@192.168.35 .10	192.168.35.68	<a href="#">192.168.35.68@192.168.35.68</a>	<input type="checkbox"/>

Figure 4.6.1 Call log

## 4.6. Log

### 4.6.1. Call log

Go to **Phone - Call Log**, users can see a list of call log which have dialed, received or missed. Users can delete calls from list.

### 4.6.2. Door Log

Go to **Phone - Door Log**, users can see a list of door log which records card information and data.

Index	Name	Code	Type	Date	Time	Status	
1	Courier	FFB59828	Card	2018-09-30	10:49:19	Failed	<input type="checkbox"/>
2	unKnown	1FEDBA28	Card	2018-09-30	10:49:16	Failed	<input type="checkbox"/>
3	Courier	FFB59828	Card	2018-09-30	10:49:09	Failed	<input type="checkbox"/>
4							<input type="checkbox"/>
5							<input type="checkbox"/>
6							<input type="checkbox"/>
7							<input type="checkbox"/>
8							<input type="checkbox"/>
9							<input type="checkbox"/>
10							<input type="checkbox"/>
11							<input type="checkbox"/>
12							<input type="checkbox"/>
13							<input type="checkbox"/>
14							<input type="checkbox"/>
15							<input type="checkbox"/>

Figure 4.6.2 Door log

### 4.6.3. System Log

Go to **Upgrade - Advanced** to configure system log level and export system log file.

**System log level:** From level from 0 to 7. The higher level means the more specific system log is saved to a temporary file. By default, it's level 3.

**Export Log:** Click to export temporary system log file to local PC.

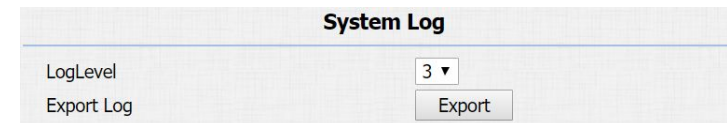

Figure 4.6.3 System log

### 4.6.4. PCAP

Go to **Upgrade - Advanced** to start, stop packets capturing or to export captured packet file.

**Start:** To start capturing all the packets file sent or received from phone.

**Stop:** To stop capturing packets.

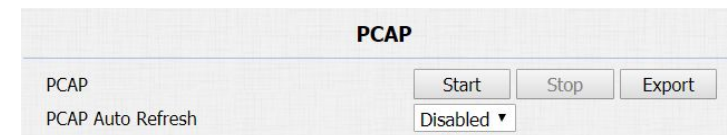

Figure 4.6.4 PCAP

## Abbreviations

**ACS:** Auto Configuration Server

**Auto:** Automatically

**AEC:** Configurable Acoustic and Line Echo Cancelers

**ACD:** Automatic Call Distribution

**Autop:** Automatical Provisioning

**AES:** Advanced Encryption Standard

**BLF:** Busy Lamp Field

**COM:** Common

**CPE:** Customer Premise Equipment

**CWMP:** CPE WAN Management Protocol

**DTMF:** Dual Tone Multi-Frequency

**DHCP:** Dynamic Host Configuration Protocol

**DNS:** Domain Name System

**DND:** Do Not Disturb

**DNS-SRV:** Service record in the Domain Name System

**FTP:** File Transfer Protocol

**GND:** Ground

**HTTP:** Hypertext Transfer Protocol

**HTTPS:** Hypertext Transfer Protocol Secure

**IP:** Internet Protocol

**ID:** Identification

**IR:** Infrared

**LCD:** Liquid Crystal Display

**LED:** Light Emitting Diode

**MAX:** Maximum

**POE:** Power Over Ethernet

**PCMA:** Pulse Code Modulation A-Law

**PCMU:** Pulse Code Modulation  $\mu$ -Law

**PCAP:** Packet Capture

**PNP:** Plug and Play

**RFID:** Radio Frequency Identification

**RTP:** Real-time Transport Protocol

**RTSP:** Real Time Streaming Protocol

**MPEG:** Moving Picture Experts Group

**MWI:** Message Waiting Indicator

**NO:** Normal Opened

**NC:** Normal Connected

**NTP:** Network Time Protocol

**NAT:** Network Address Translation

**NVR:** Network Video Recorder

**ONVIF:** Open Network Video Interface Forum

**SIP:** Session Initiation Protocol

**SNMP:** Simple Network Management Protocol

**STUN:** Session Traversal Utilities for NAT

**SMTP:** Simple Mail Transfer Protocol

**SDMC:** SIP Devices Management Center

**TR069:** Technical Report069

**TCP:** Transmission Control Protocol

**TLS:** Transport Layer Security

**TFTP:** Trivial File Transfer Protocol

**UDP:** User Datagram Protocol

**URL:** Uniform Resource Locator

**VLAN:** Virtual Local Area Network

**WG:** Wiegand

## Contact us

For more information about the product, please visit us at [www.akuvox.com](http://www.akuvox.com) or feel free to contact us by

Sales email: [sales@akuvox.com](mailto:sales@akuvox.com)

Technical support email: [techsupport@akuvox.com](mailto:techsupport@akuvox.com)

Telephone: +86-592-2133061 ext.7694/8162

**We highly appreciate your feedback about our products.**

