

Applicable Model

R20BX5

Drawing Title

Intercom Panel

Drawing Unit

mm

Drawing Scale

Not to scale

**DRAFT
SUBJECT TO
CHANGE**

Last Revised

Feb 05,2021

Drawing Version

V1.0

Page

1 of 6

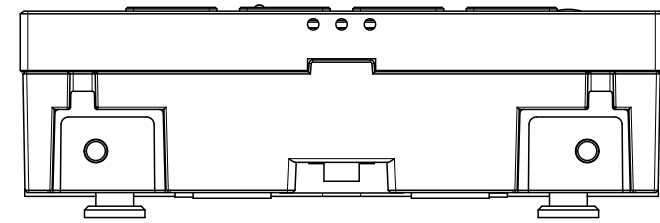

5 TOP VIEW

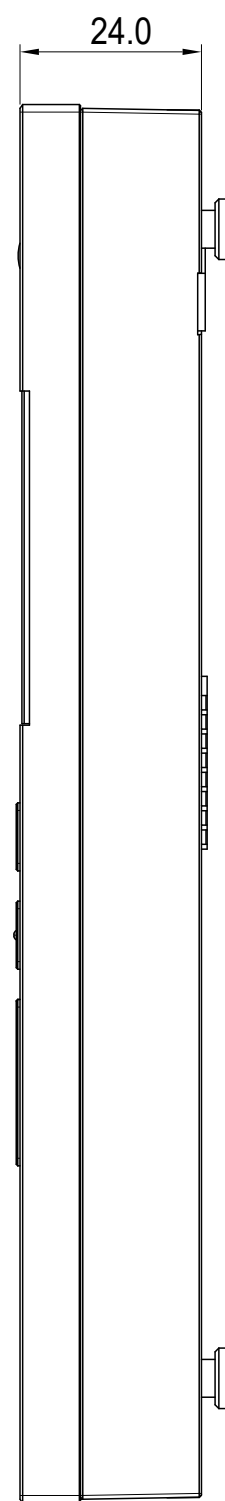

2 RIGHT VIEW

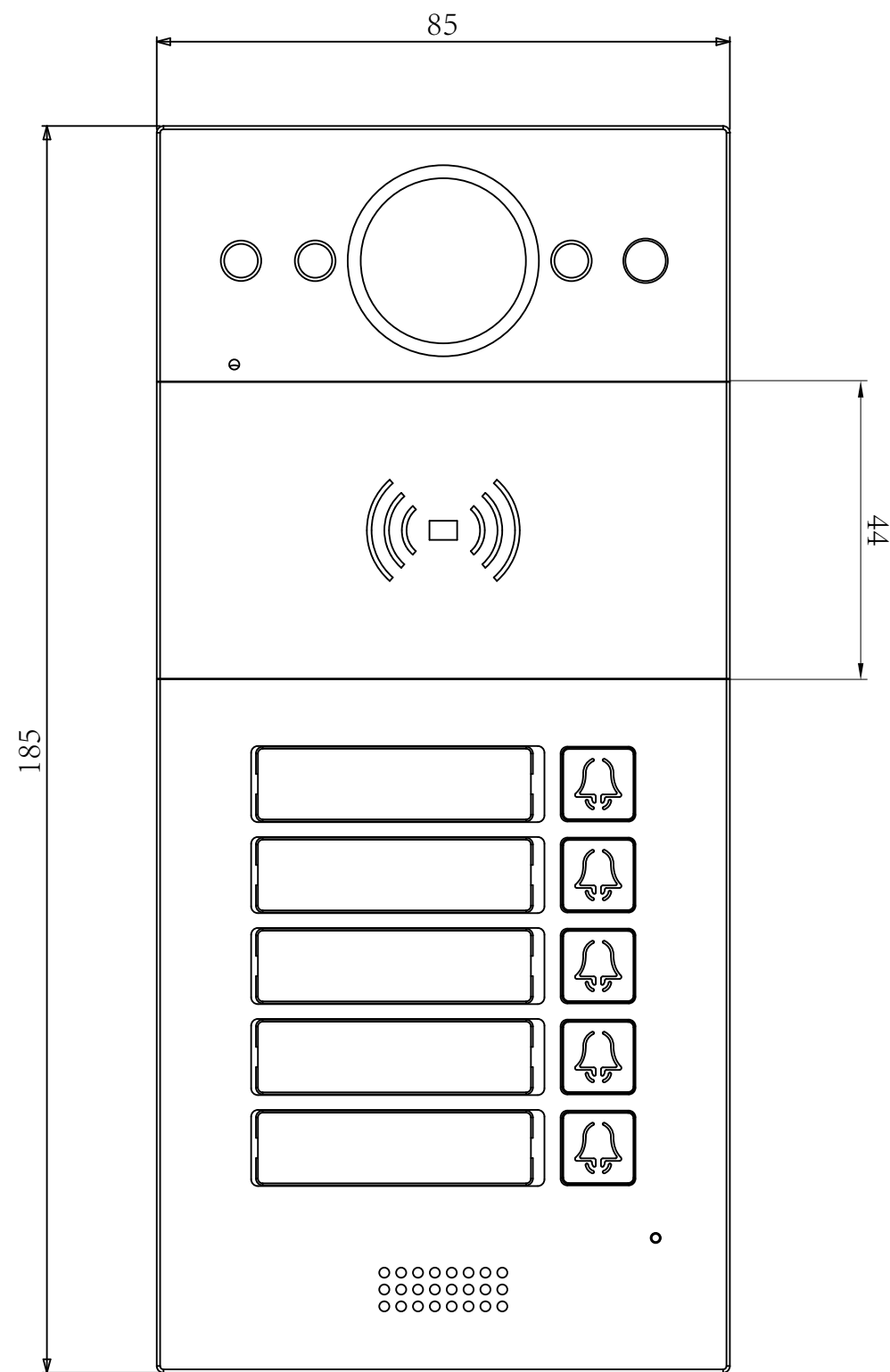

1 FRONT VIEW

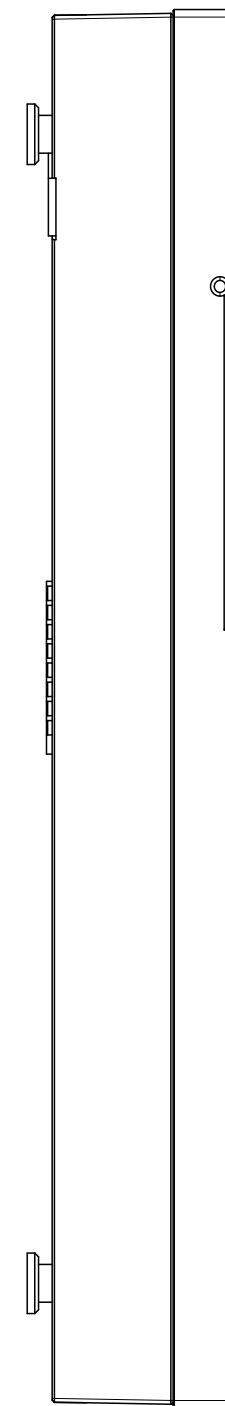

3 LEFT VIEW

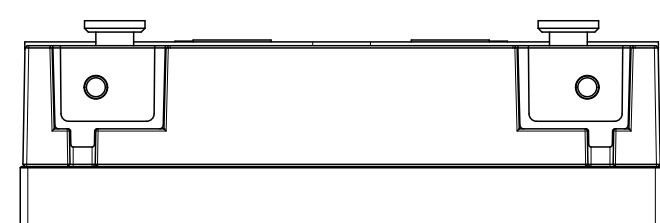

6 BOTTOM VIEW

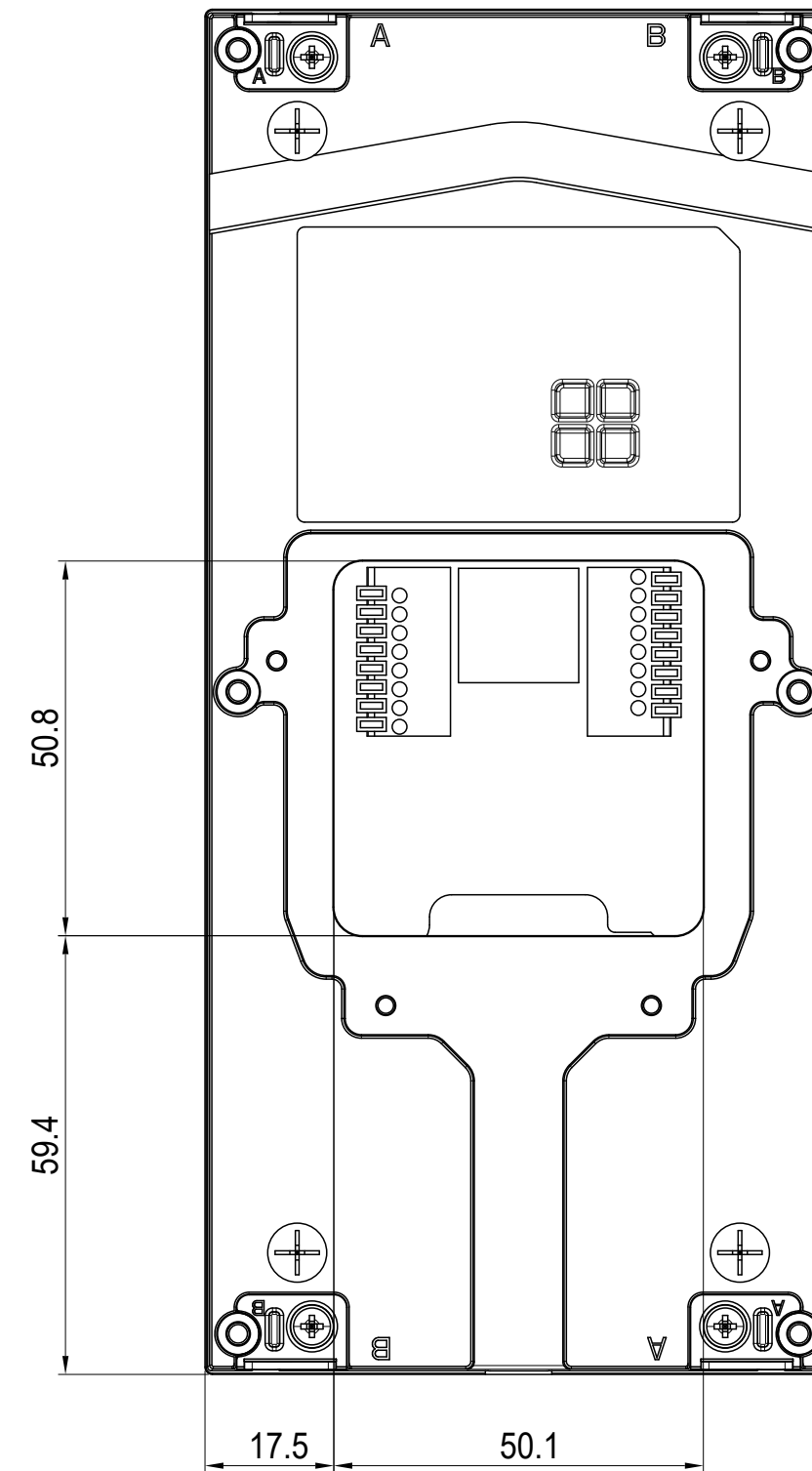

4 BACK VIEW

Applicable Model

R20B

Drawing Title

Wall Mounting Bracket

Drawing Unit

mm

Drawing Scale

Not to scale

**DRAFT
SUBJECT TO
CHANGE**

Last Revised

Feb 05,2021

Drawing Version

V1.0

Page

2 of 6

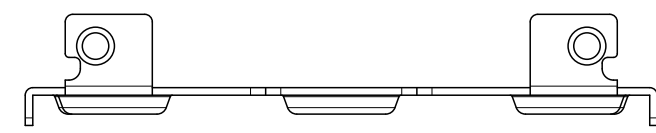

5 **TOP VIEW**

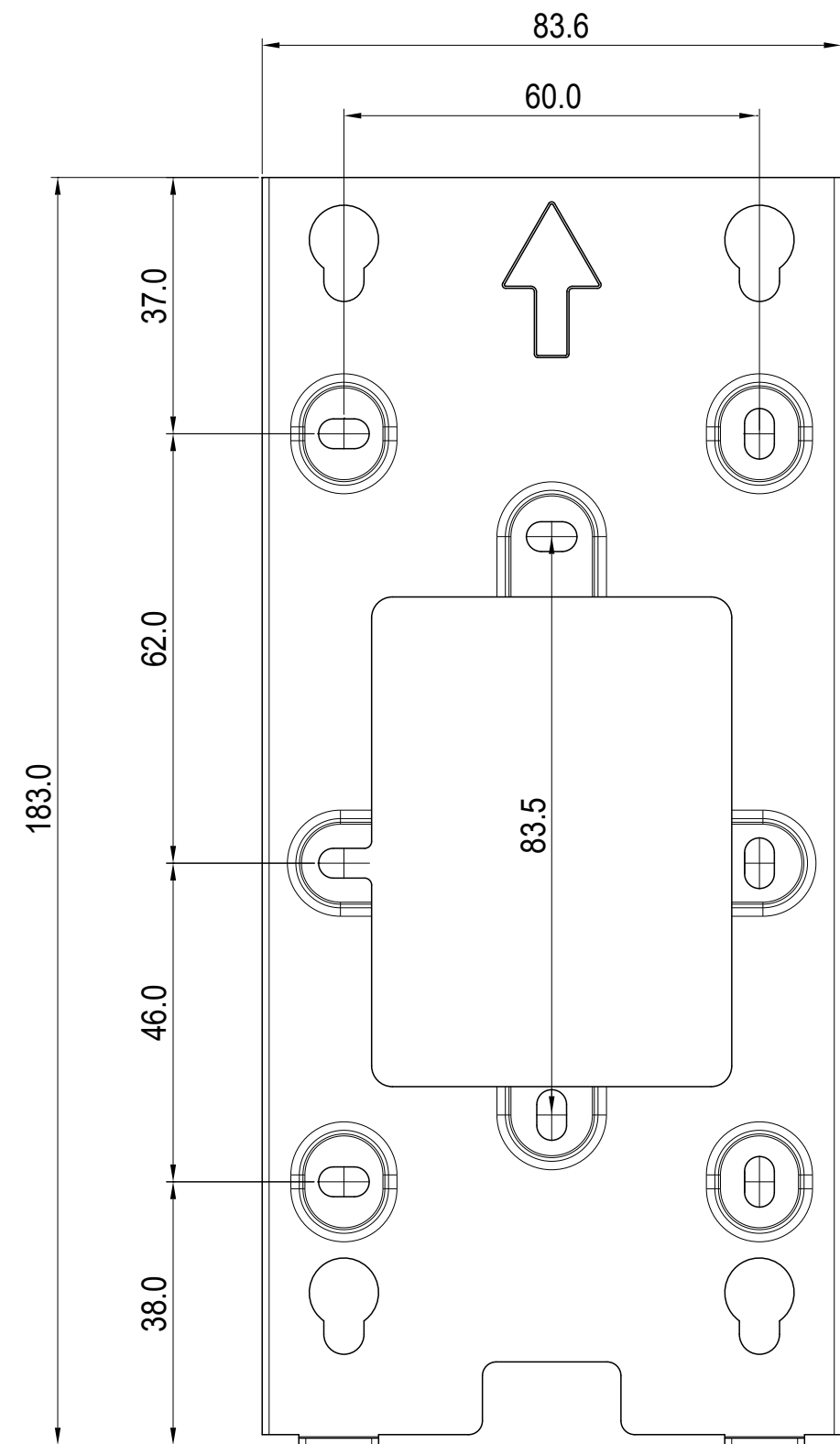

1 **FRONT VIEW**

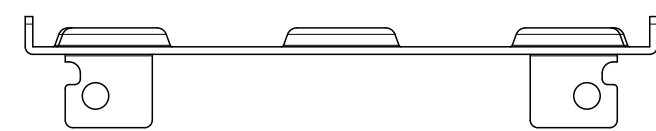

6 **BOTTOM VIEW**

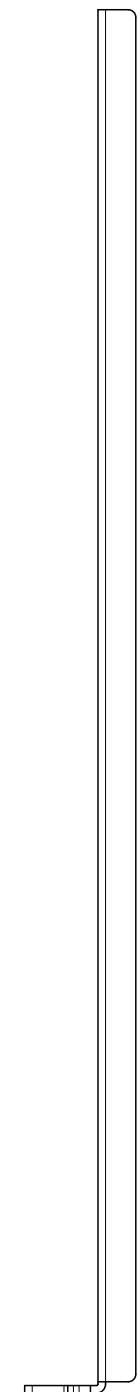

2 **RIGHT VIEW**

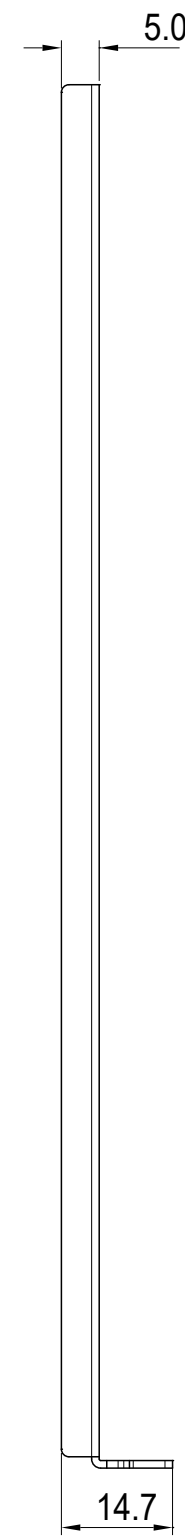

3 **LEFT VIEW**

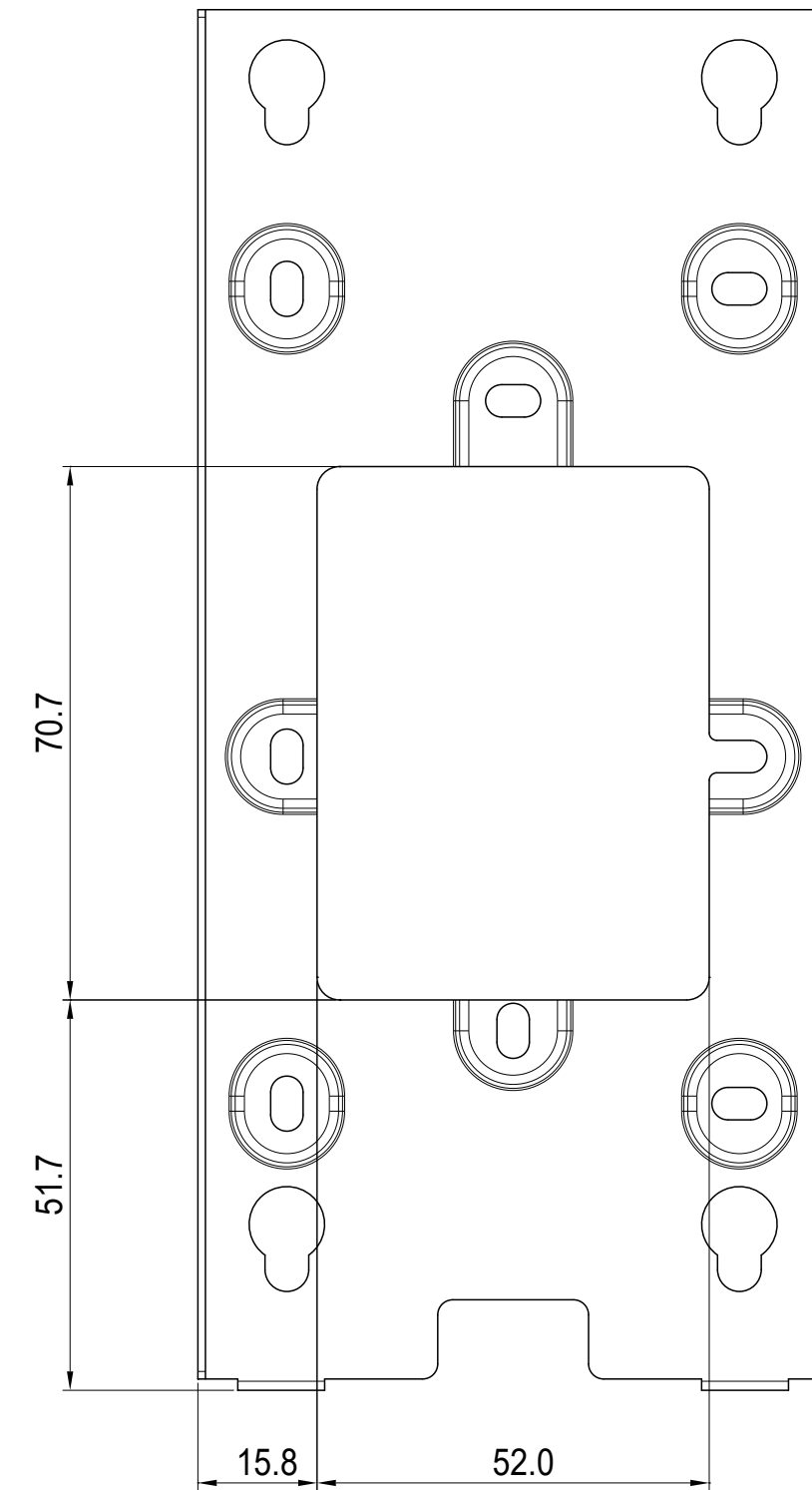

4 **BACK VIEW**

Applicable Model

R20BX5

Drawing Title

Placement

Drawing Unit

mm

Drawing Scale

Not to scale

**DRAFT
SUBJECT TO
CHANGE**

Last Revised

Feb 05,2021

Drawing Version

V1.0

Page

3 of 6

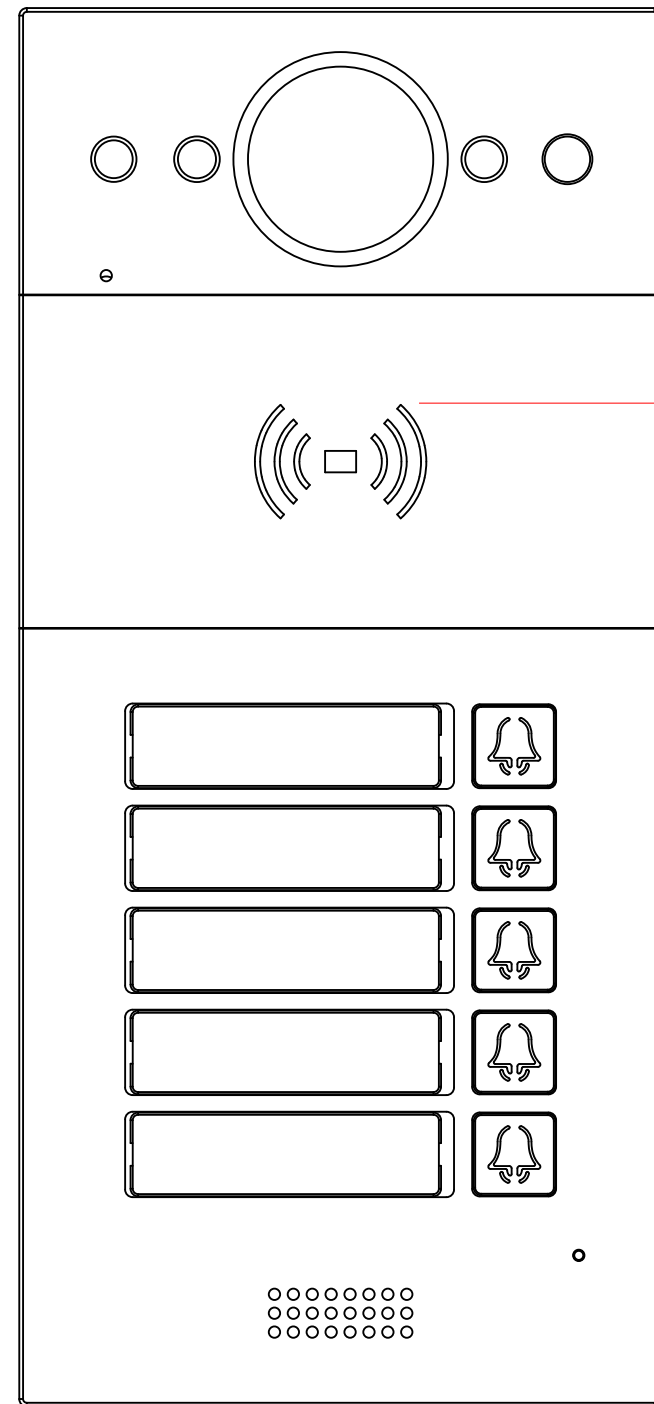

1 INTERCOM PANEL FRONT VIEW

1117.4mm TO BOTTOM OF PANEL

1220mm MAX TO TOP OF USABLE PARTS

ADA Compliance Requirement

GROUND

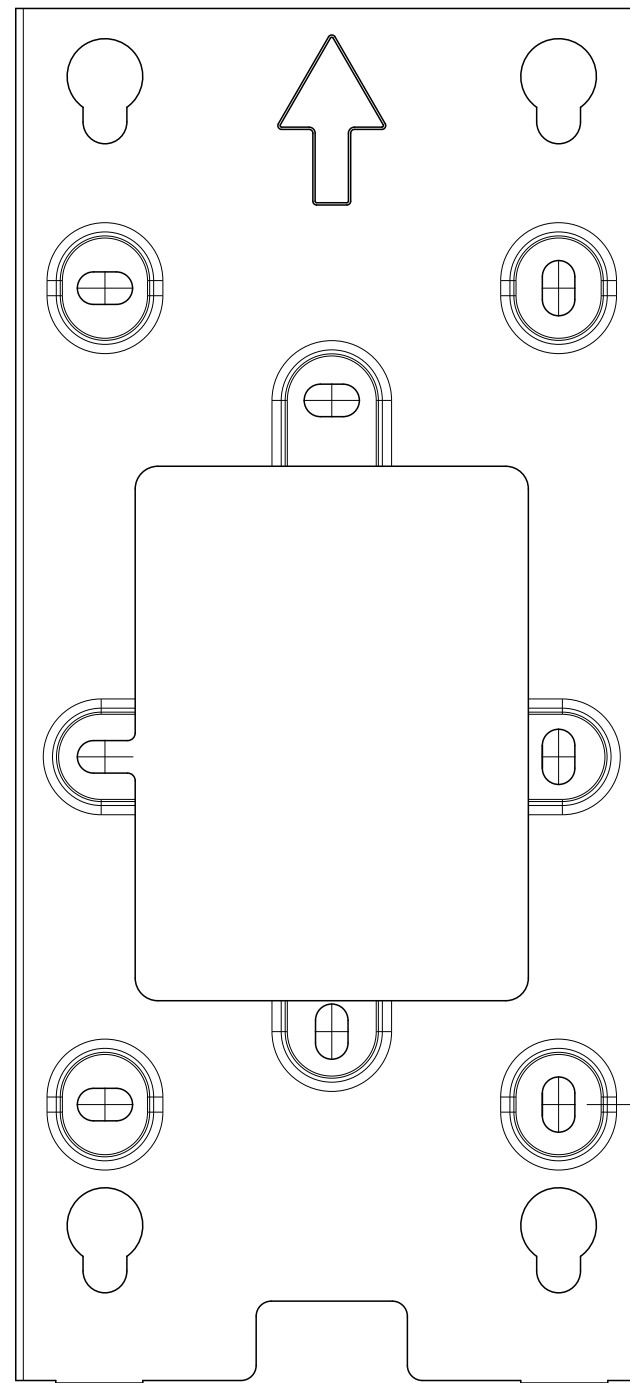

2 FRONT VIEW:WALL MOUNTING BRACKET PLACEMENT

1121.3mm TO BOTTOM OF BRACKET

1159.3mm TO SCREW HOLE CENTER OF BRACKET

GROUND

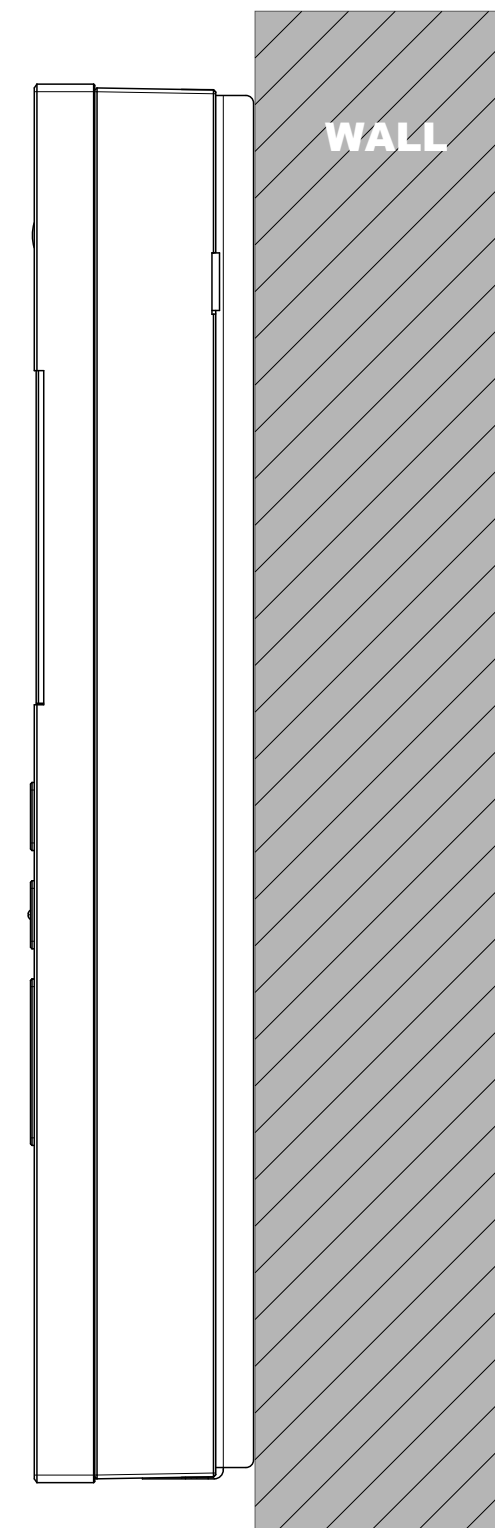

3 SIDE VIEW:INTERCOM PANEL ON WALL

Applicable Model

R20B

Drawing Title

Decorative Panel

Drawing Unit

mm

Drawing Scale

Not to scale

**DRAFT
SUBJECT TO
CHANGE**

Last Revised

Feb 05,2021

Drawing Version

V1.0

Page

4 of 6

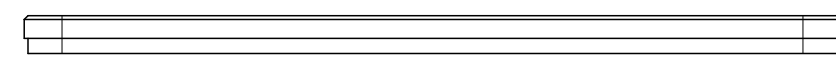

5 **TOP VIEW**

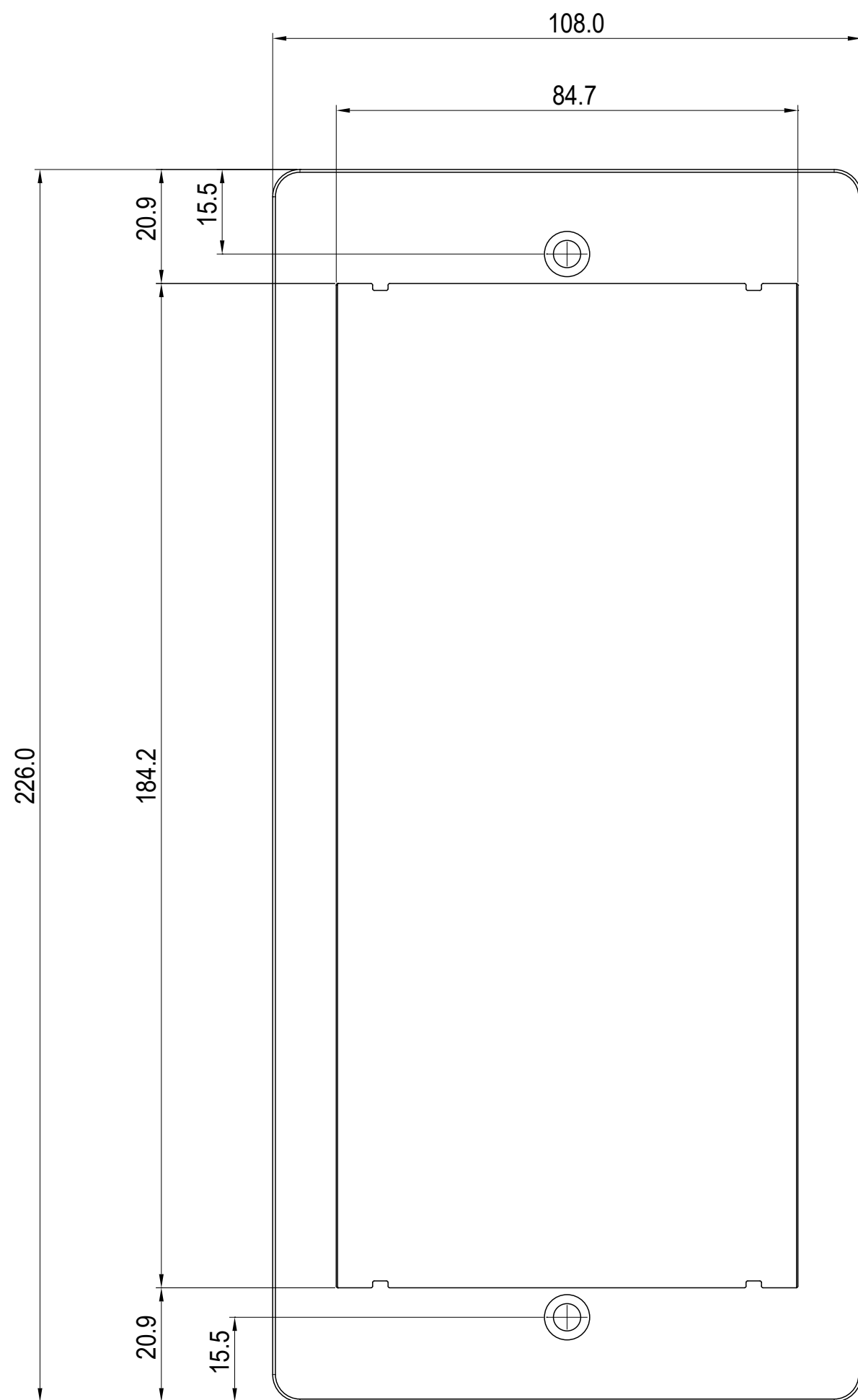

1 **FRONT VIEW**



2 **RIGHT VIEW**



3 **LEFT VIEW**

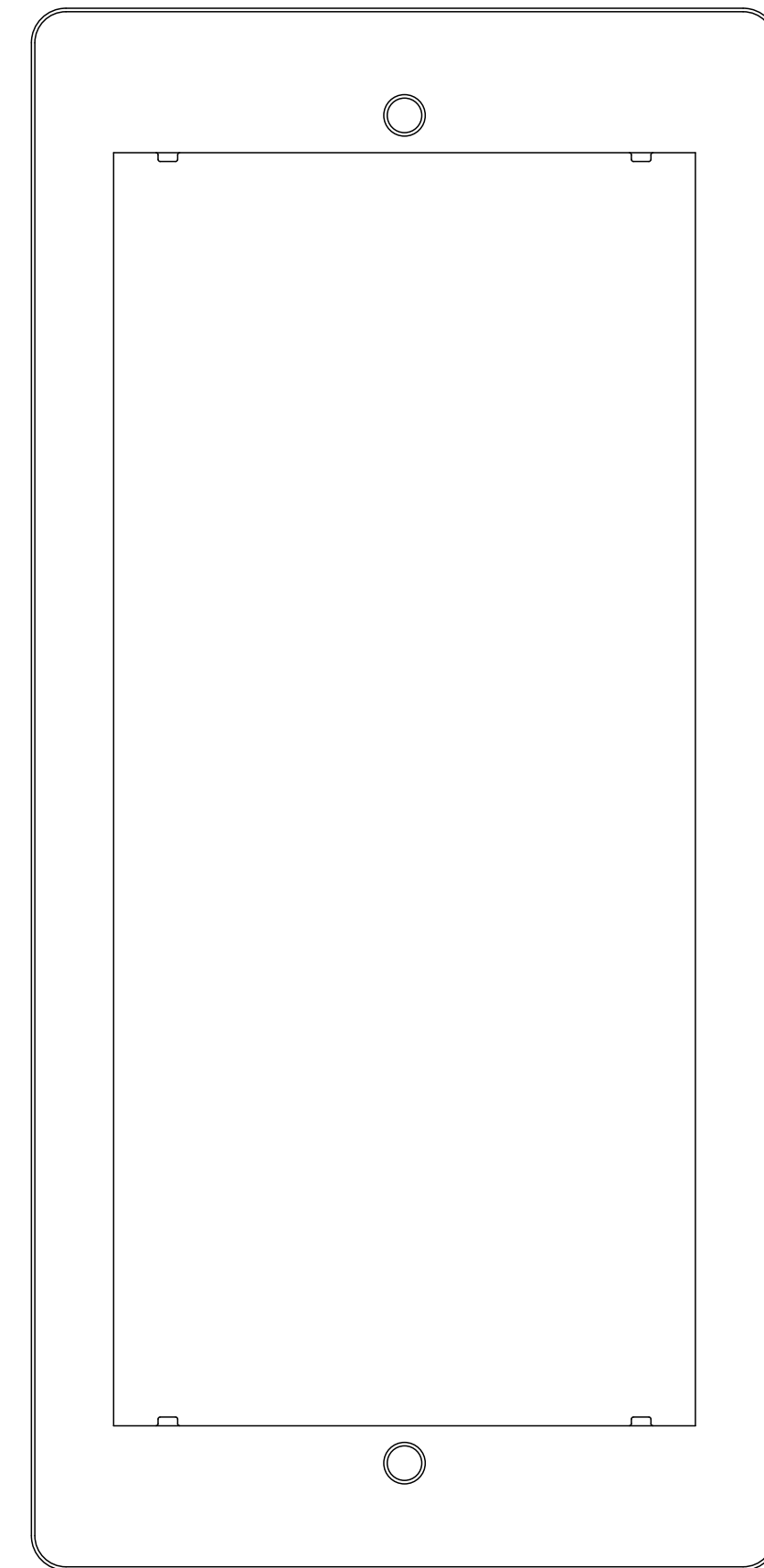

4 **BACK VIEW**

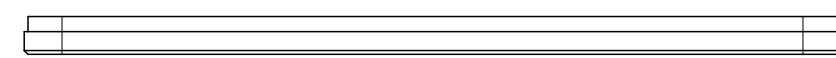

6 **BOTTOM VIEW**

Applicable Model

R20B

Drawing Title

Flush Mounting Box

Drawing Unit

mm

Drawing Scale

Not to scale

**DRAFT
SUBJECT TO
CHANGE**

Last Revised

Feb 05,2021

Drawing Version

V1.0

Page

5 of 6

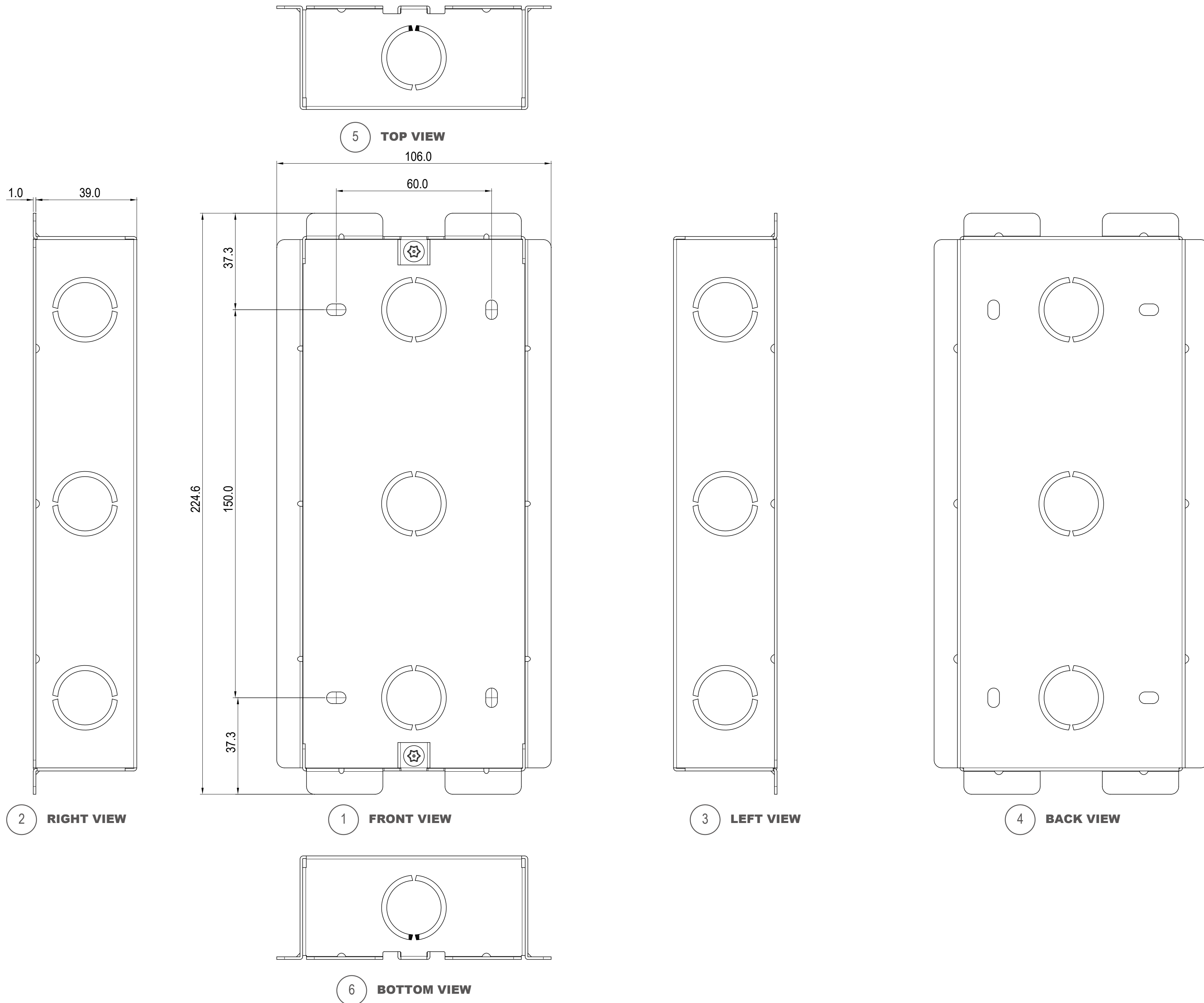

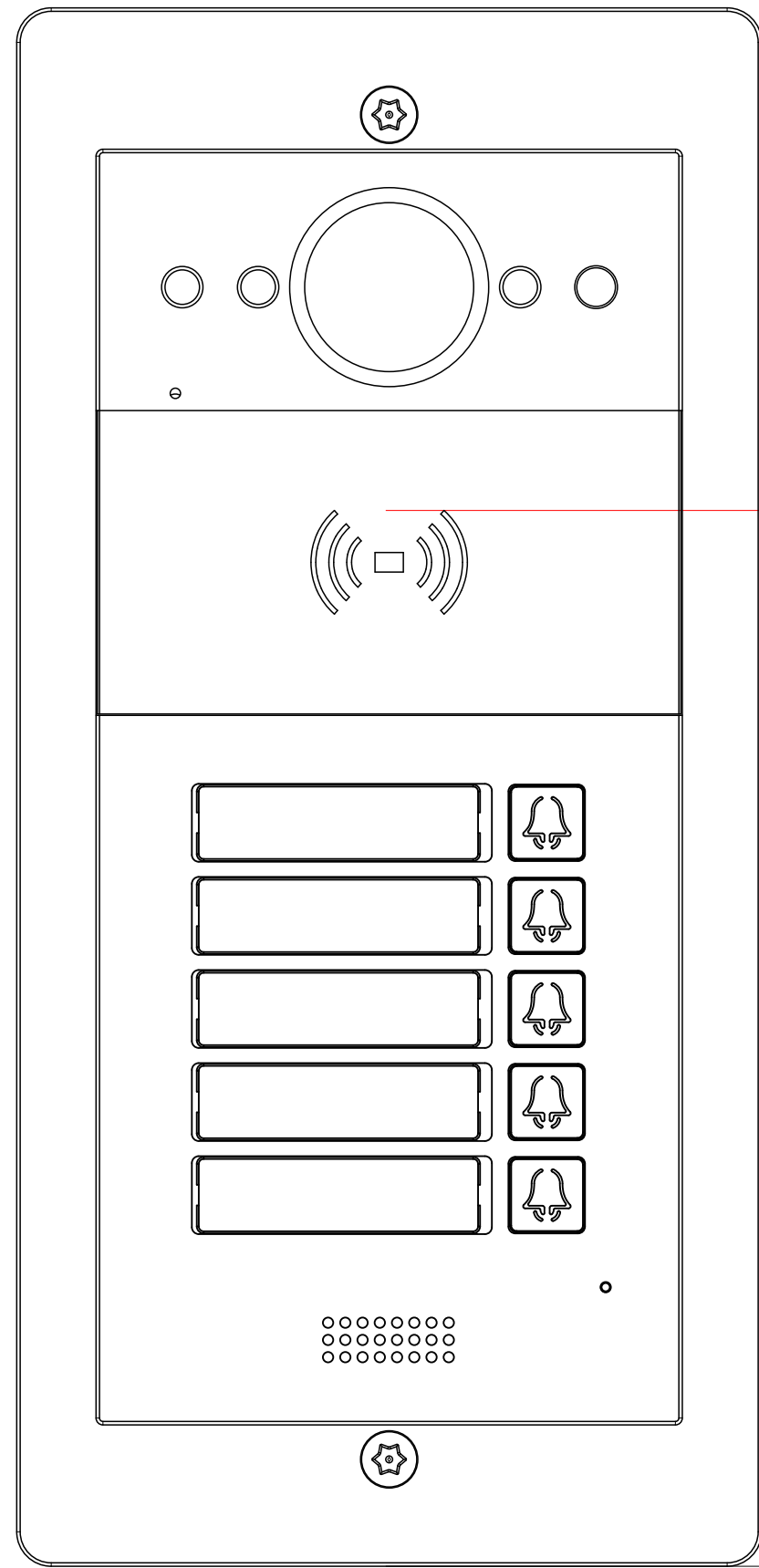

1 INTERCOM PANEL FRONT VIEW

1097mm TO BOTTOM OF PANEL

1220mm MAX TO TOP OF USABLE PARTS

ADA Compliance Requirement

GROUND

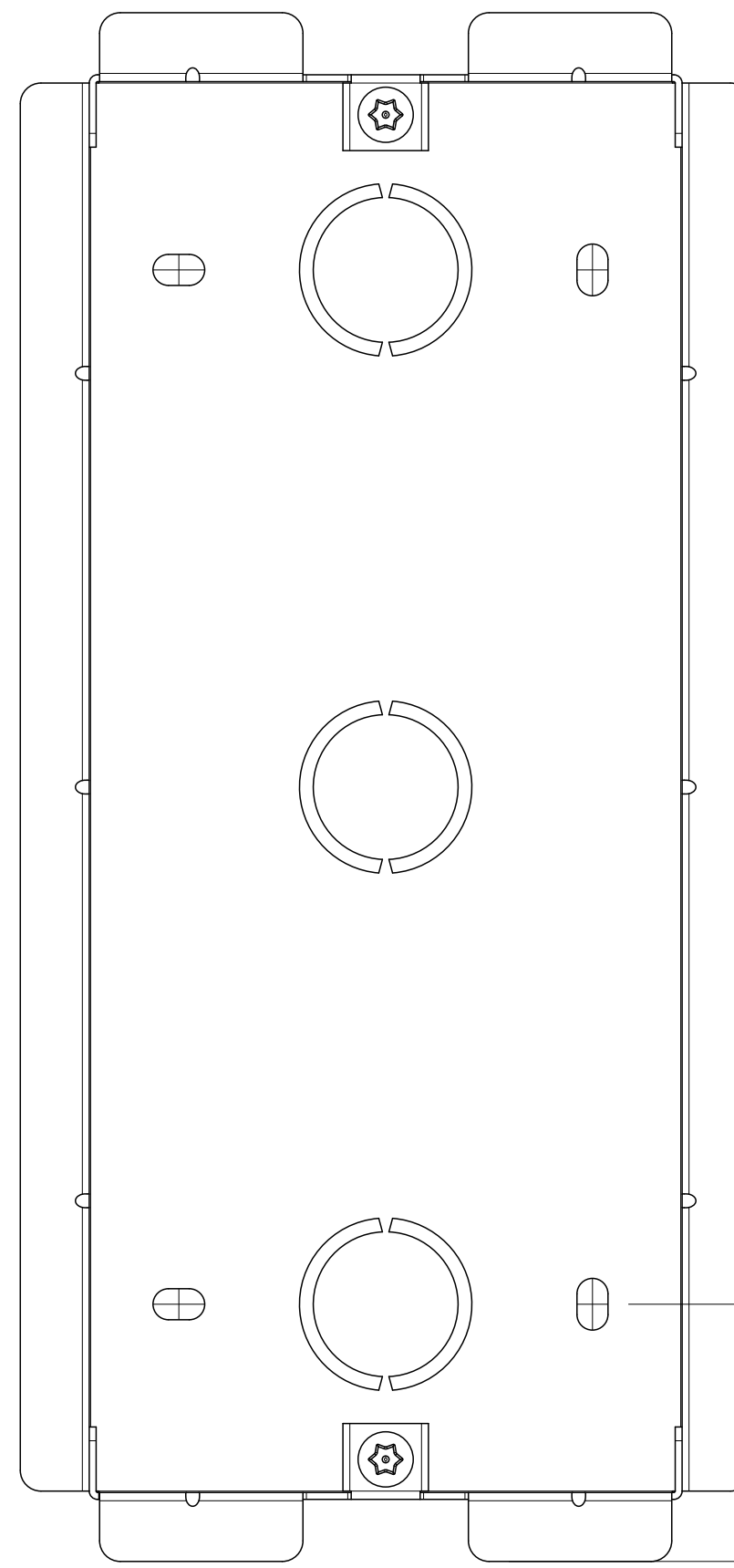

2 FRONT VIEW: FLUSHING MOUNTING BOX PLACEMENT

1097.6mm TO BOTTOM OF BRACKET

1134.9mm TO SCREW HOLE CENTER OF BRACKET

GROUND

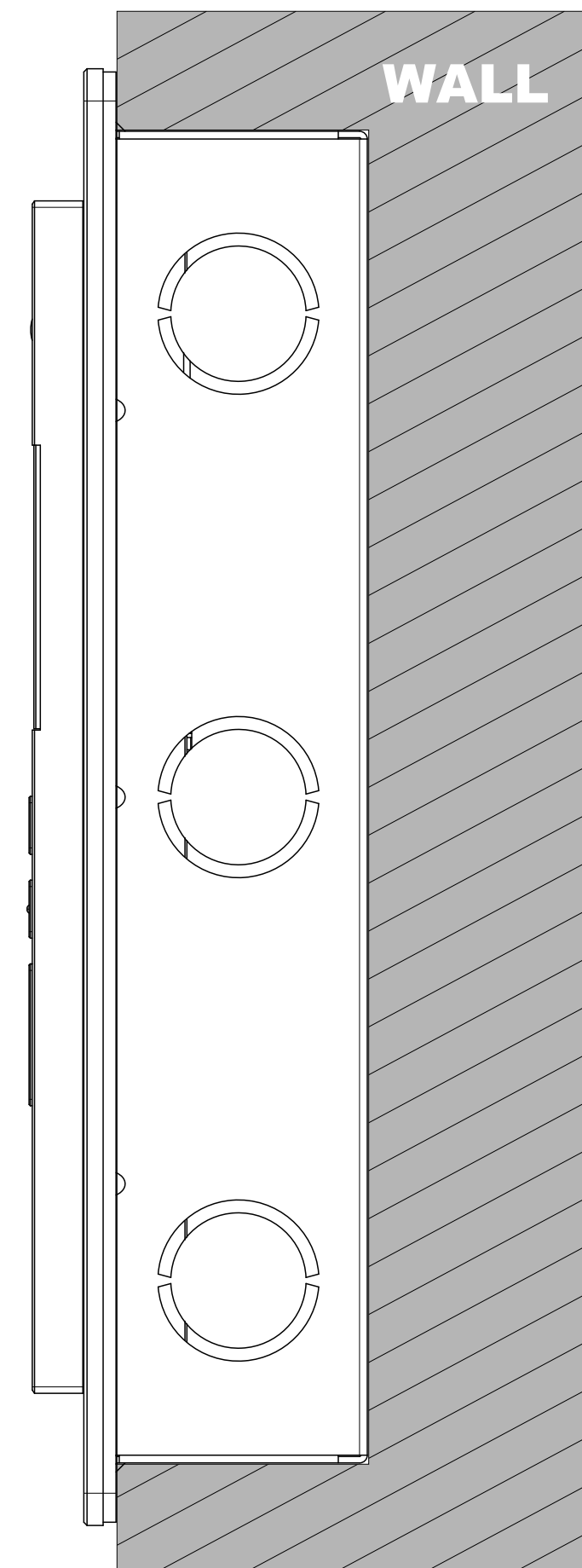

3 SIDE VIEW: INTERCOM PANEL IN WALL

Applicable Model

R20BX5

Drawing Title

Placement

Drawing Unit

mm

Drawing Scale

Not to scale

**DRAFT
SUBJECT TO
CHANGE**

Last Revised

Feb 05,2021

Drawing Version

V1.0

Page

6 of 6