

Applicable Model
S539

Drawing Title
Intercom Panel

Drawing Unit
mm

Drawing Scale
Not to scale

DRAFT
SUBJECT TO
CHANGE

Last Revised
Sept 17, 2025

Drawing Version
V1.0

Page
1 of 9

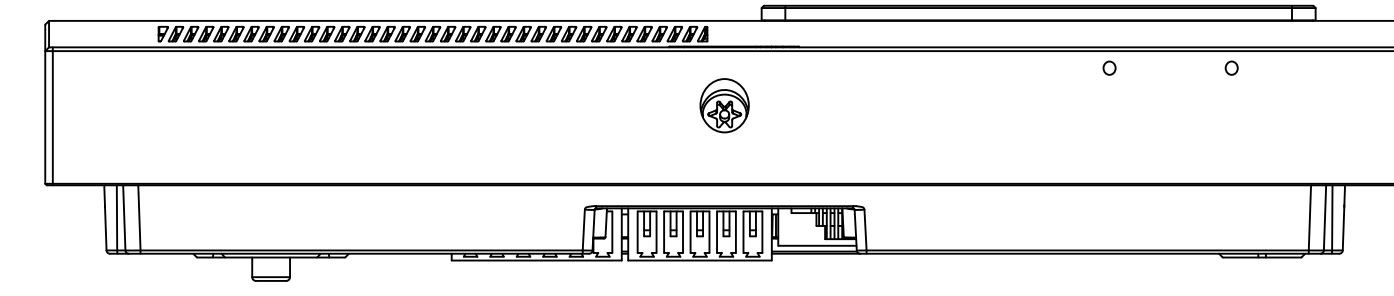

6 **BOTTOM VIEW**

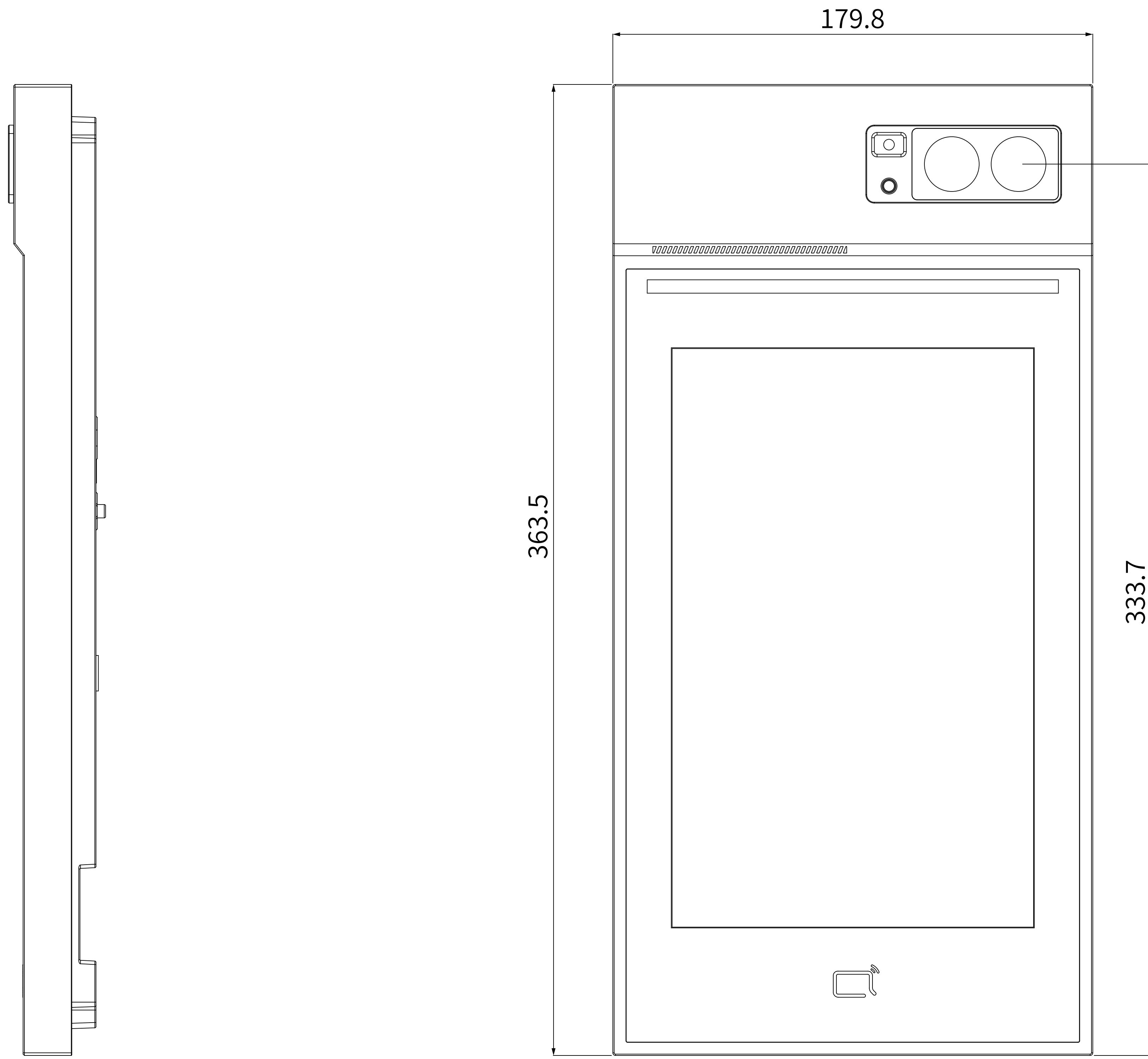

1 **FRONT VIEW**

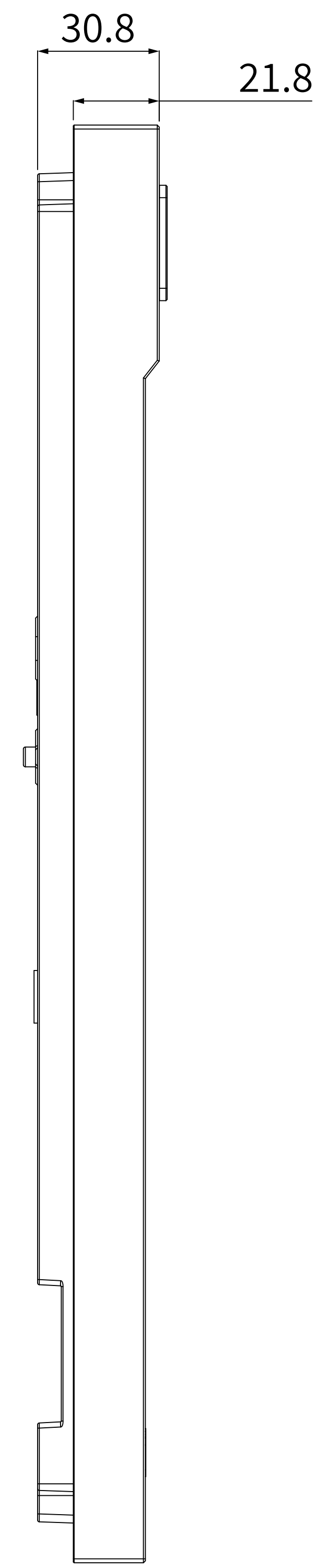

3 **LEFT VIEW**

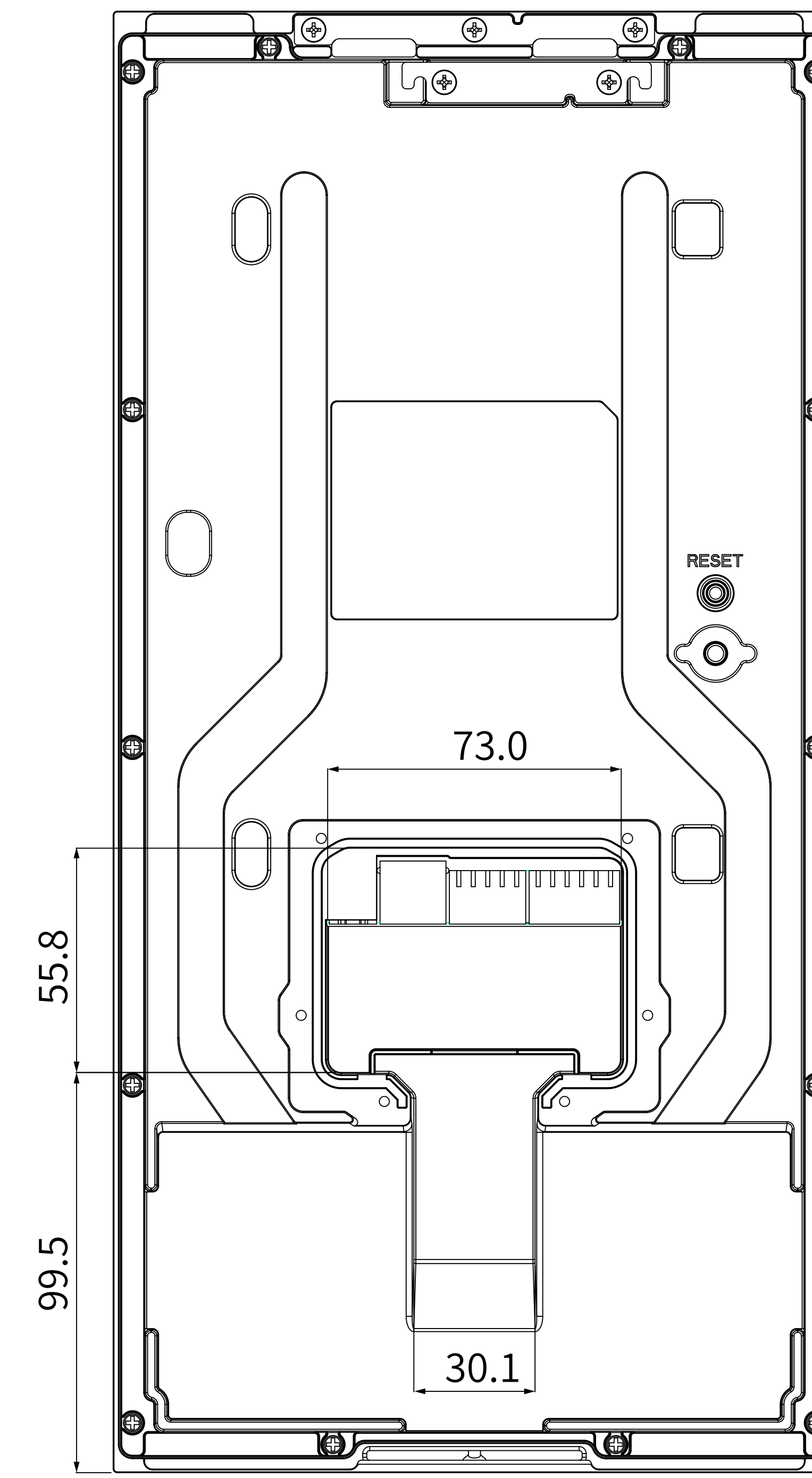

4 **BACK VIEW**

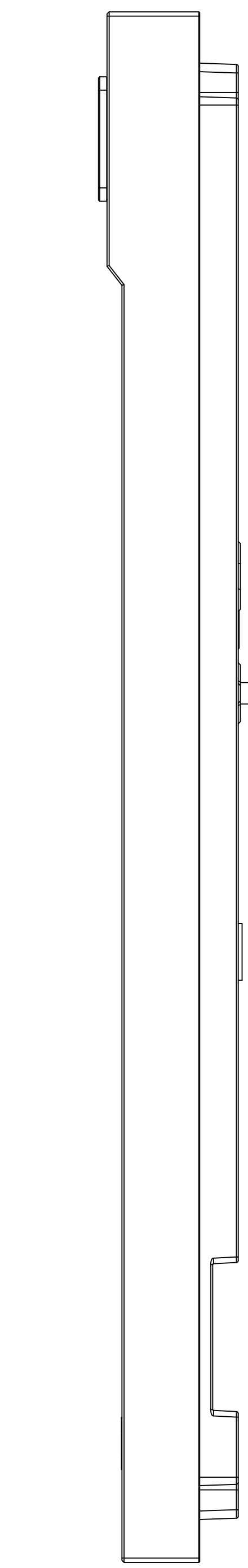

2 **RIGHT VIEW**

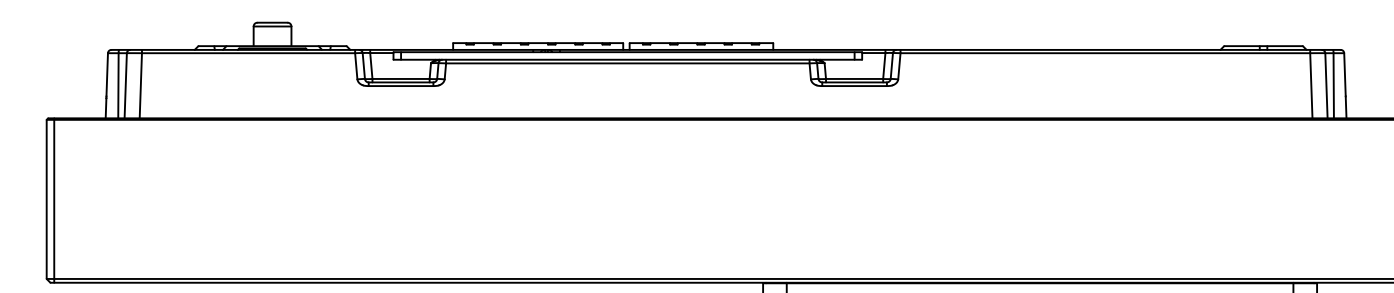

5 **TOP VIEW**

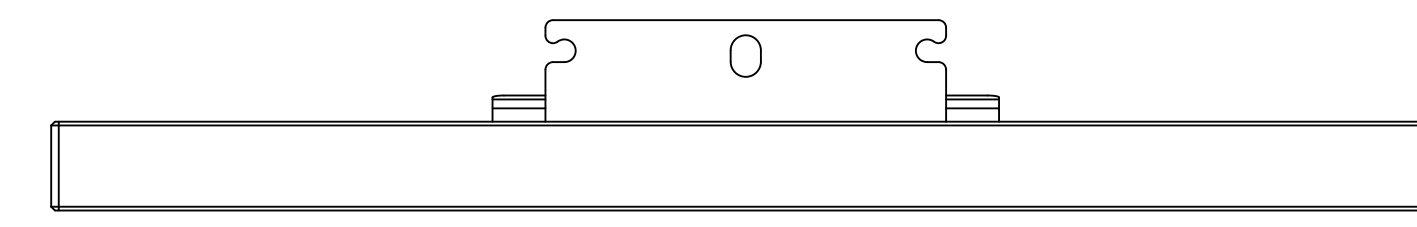

6 **BOTTOM VIEW**

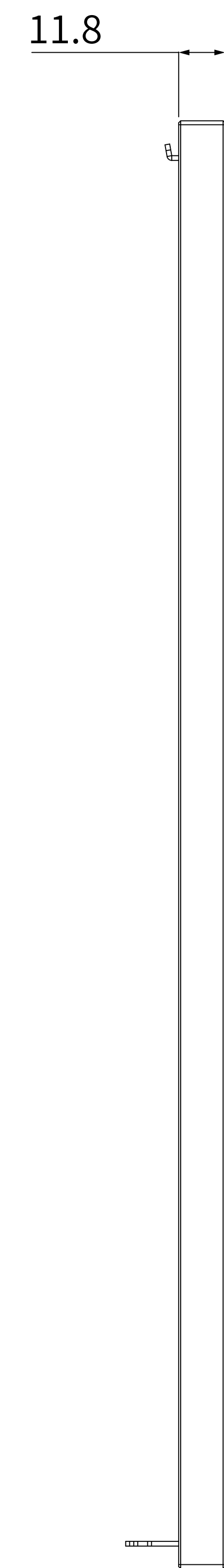

2 **RIGHT VIEW**

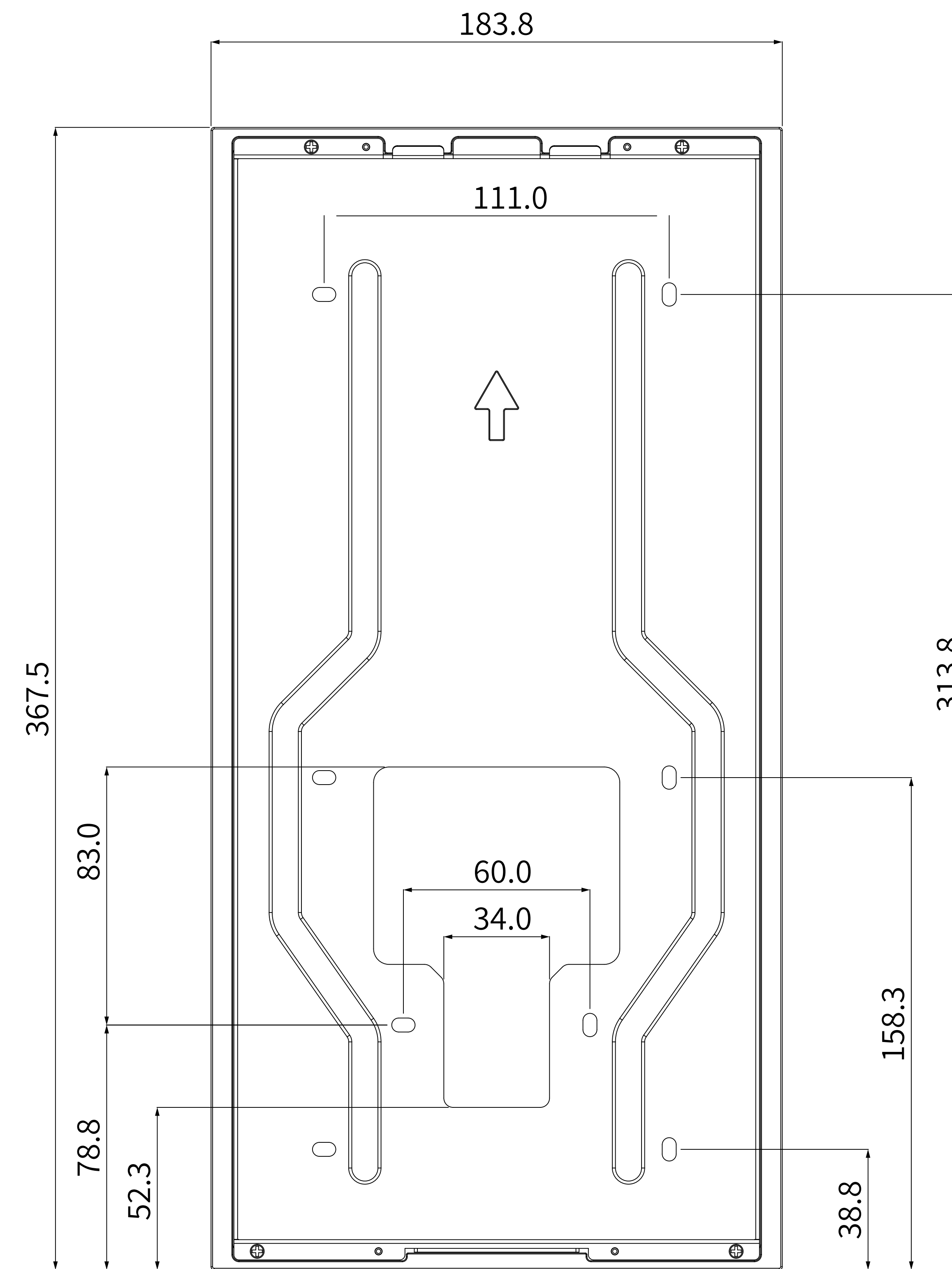

1 **FRONT VIEW**

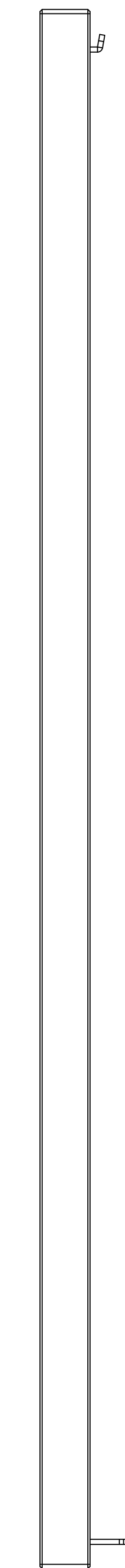

3 **LEFT VIEW**

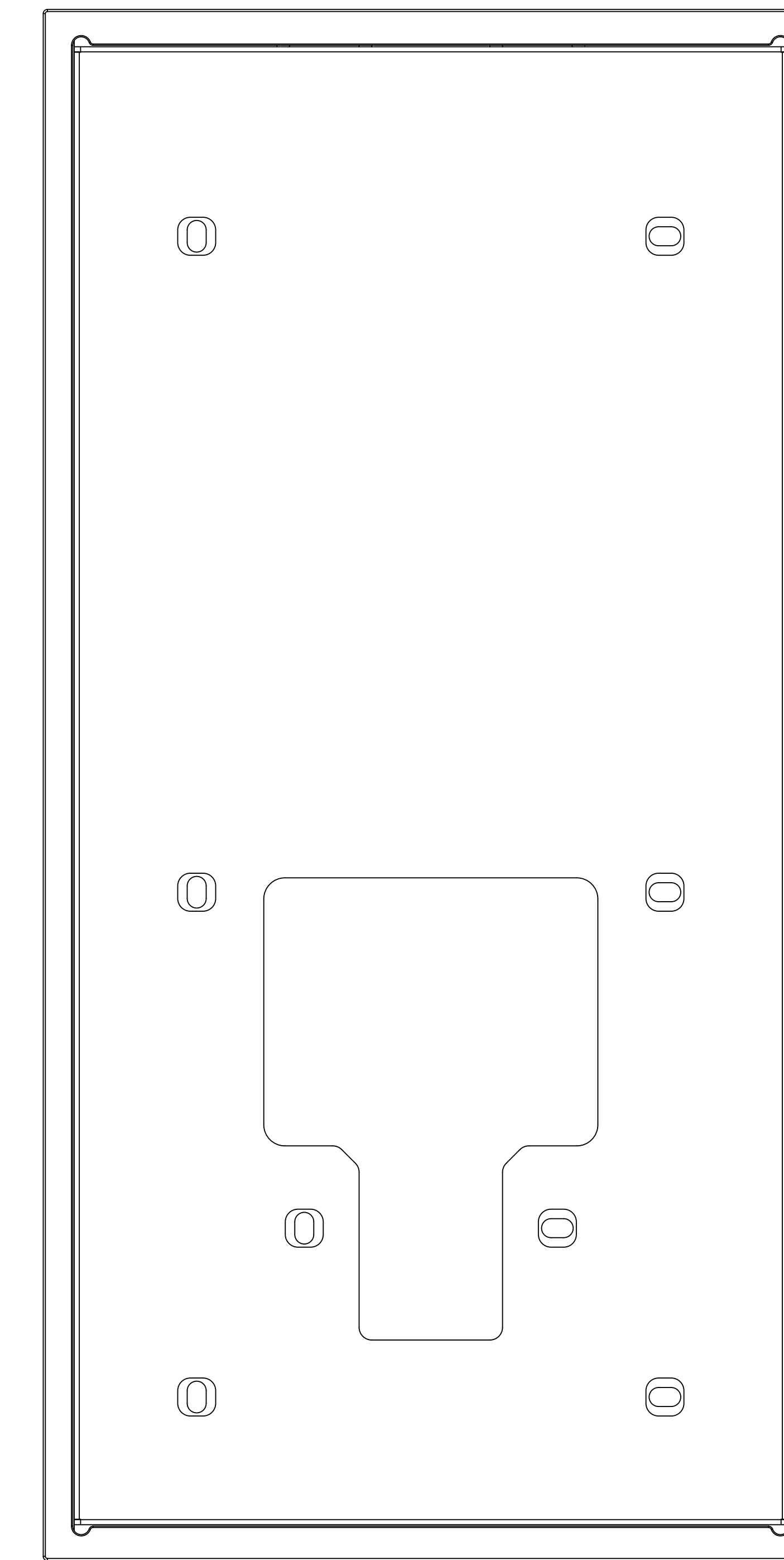

4 **BACK VIEW**

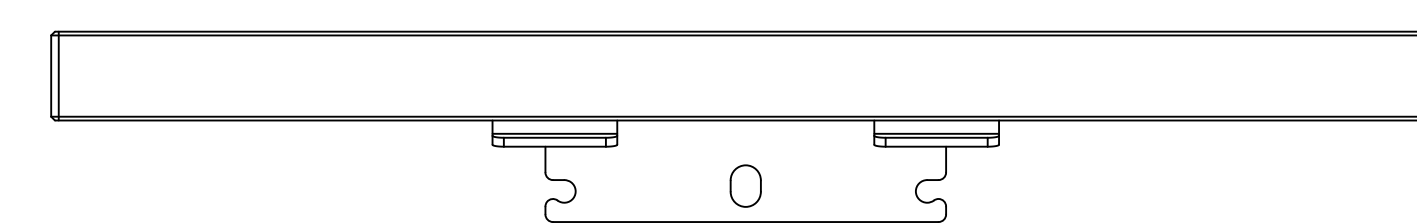

5 **TOP VIEW**

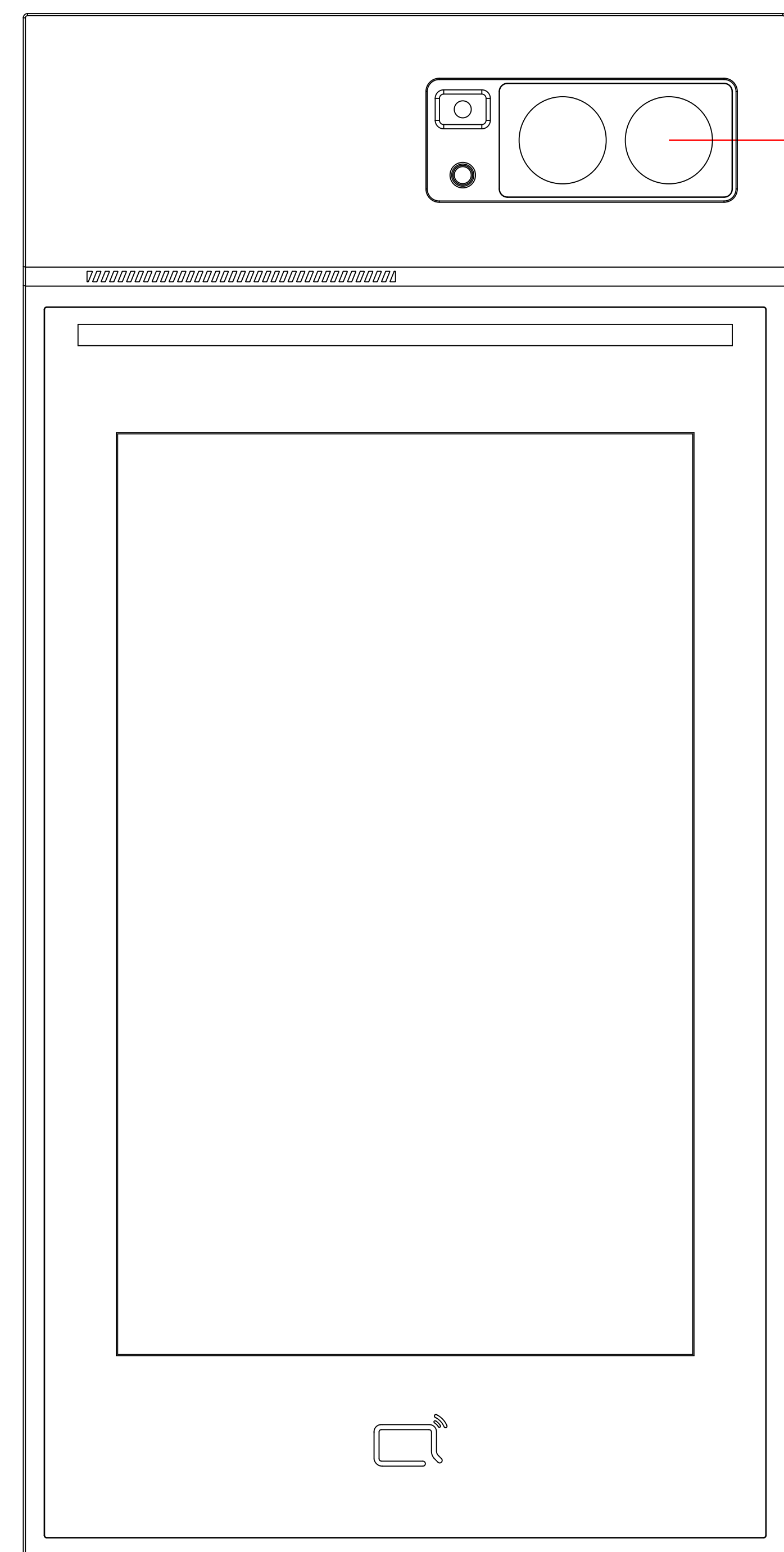

① INTERCOM PANEL FRONT VIEW

1166mm TO BOTTON OF PANEL

1500mm TO CENTER OF CAMERA

ADA Compliance Requirement

GROUND

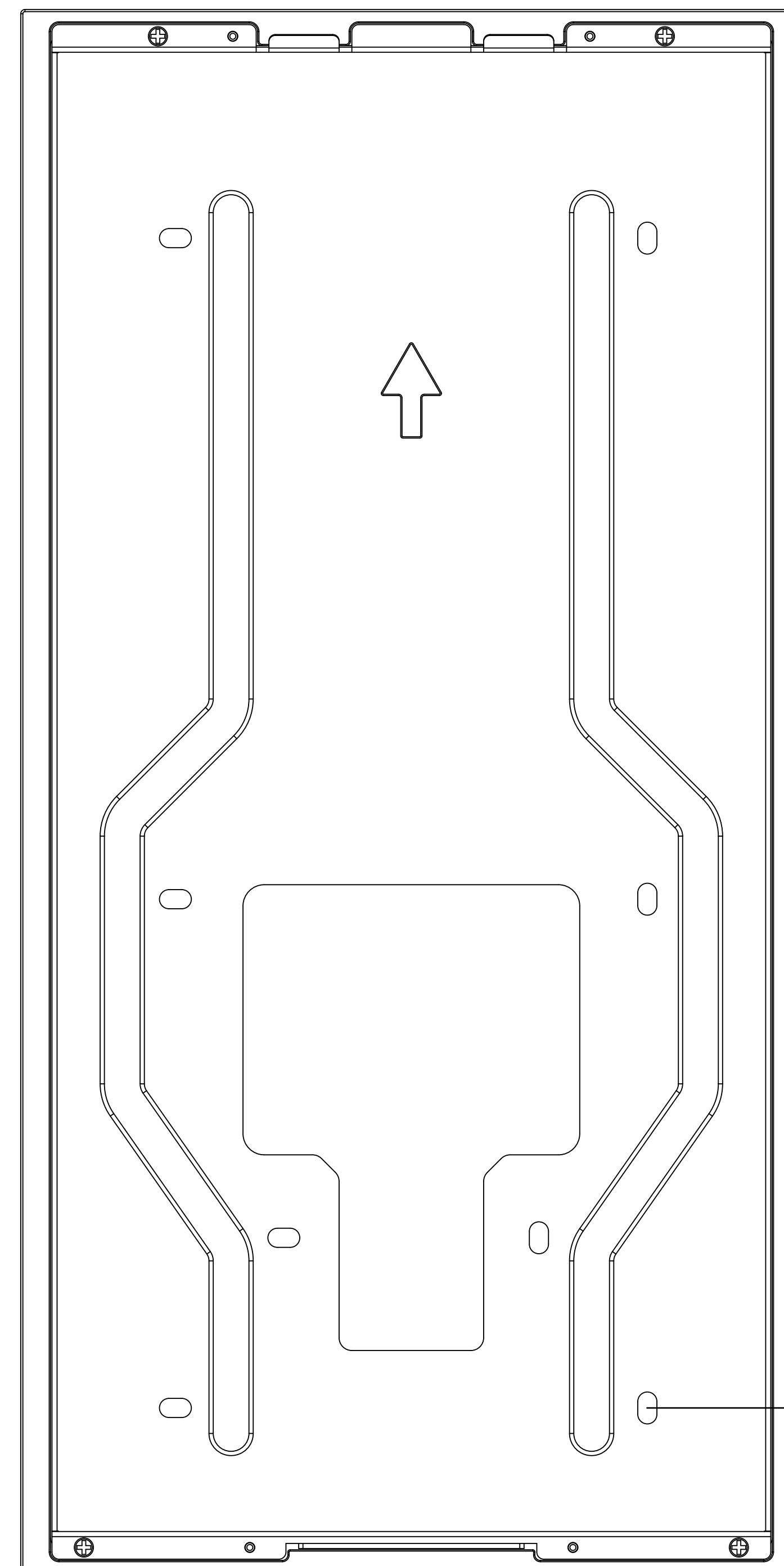

② BRACKET PLACEMENT

1164mm TO BOTTON OF BRACKET

1203mm TO SCREW HOLE CENTER OF BRACKET

GROUND

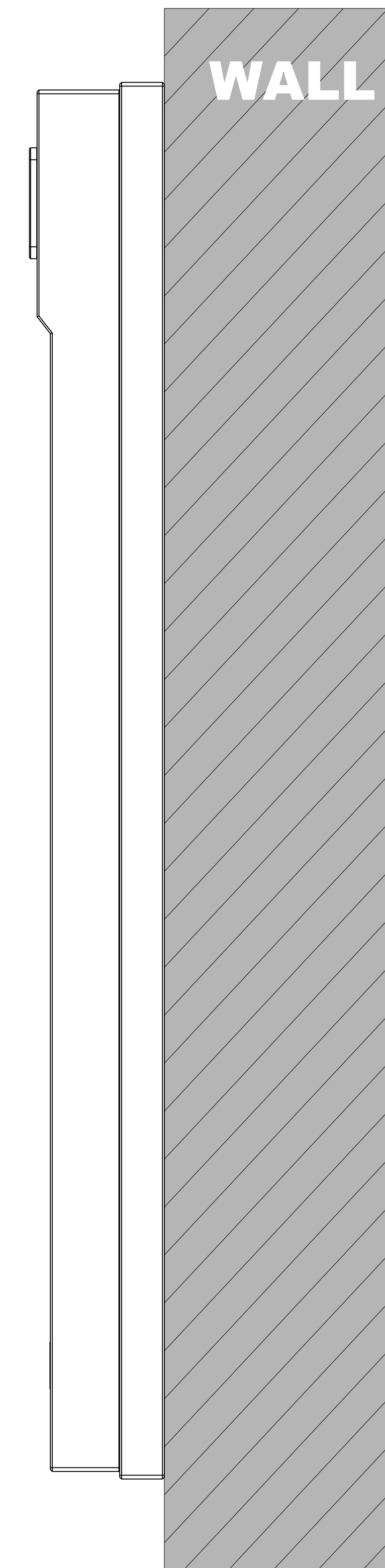

③ SIDE VIEW:INTERCOM ON WALL

WALL

Applicable Model
S539

Drawing Title
Flush Mounting Box

Drawing Unit
mm

Drawing Scale
Not to scale

DRAFT
SUBJECT TO
CHANGE

Last Revised
Sept 17, 2025

Drawing Version
V1.0

Page
4 of 9

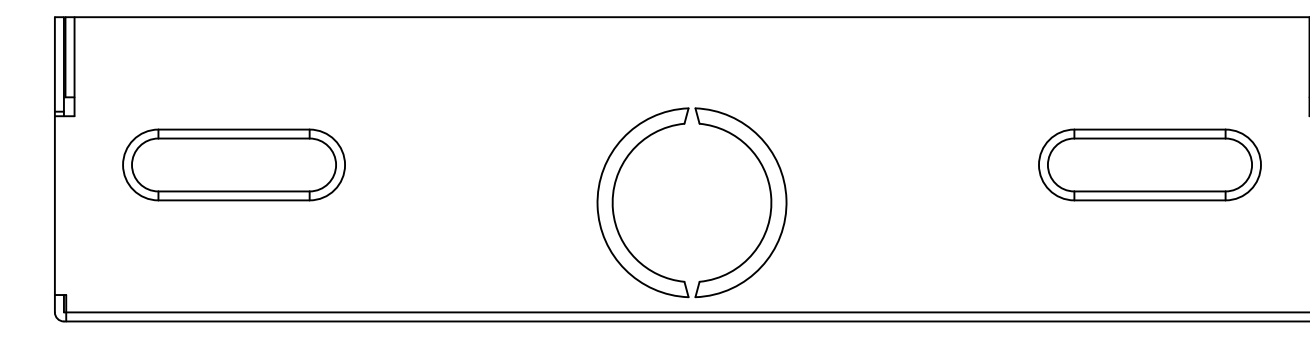

6 **BOTTOM VIEW**

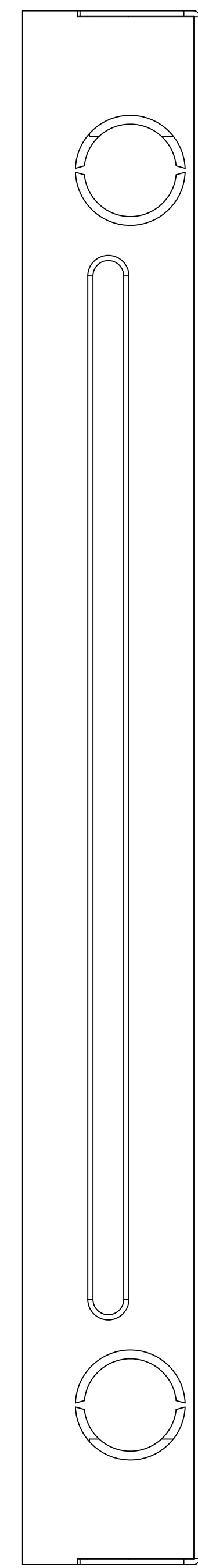

2 **RIGHT VIEW**

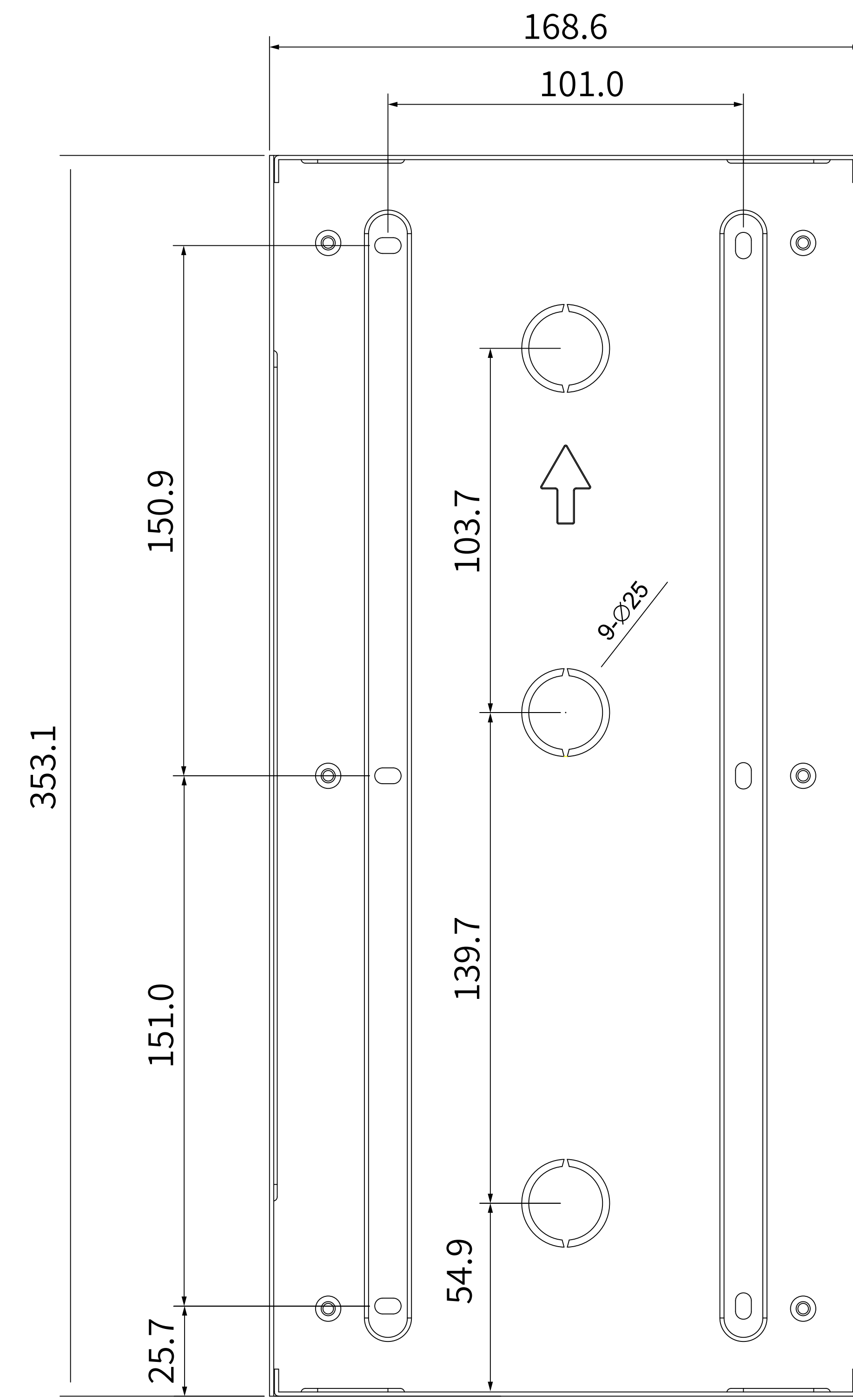

1 **FRONT VIEW**

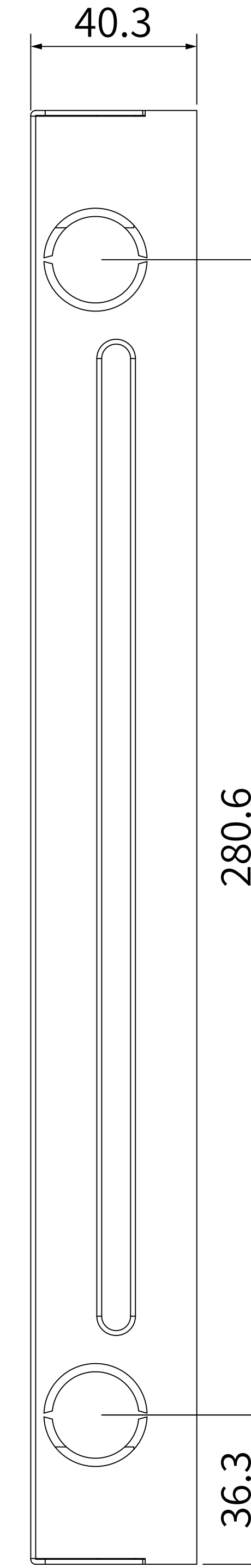

3 **LEFT VIEW**

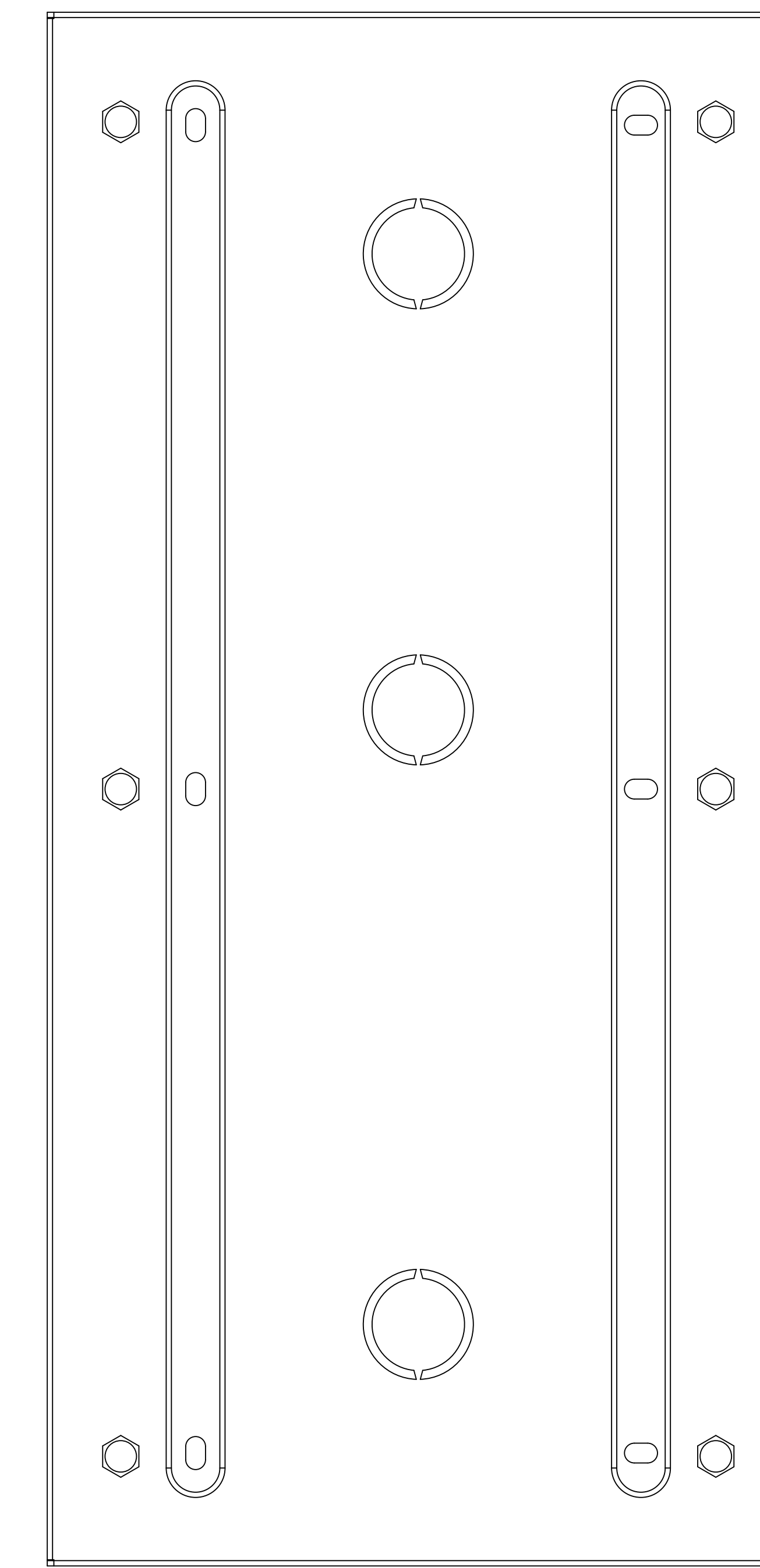

4 **BACK VIEW**

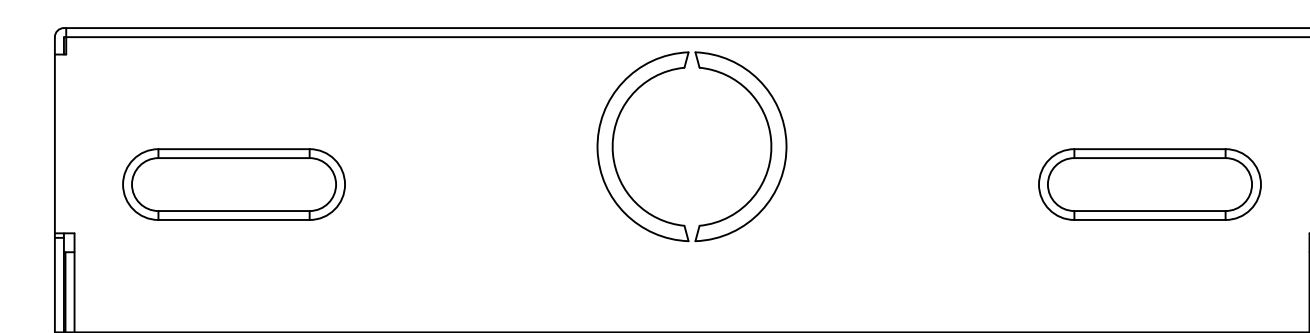

5 **TOP VIEW**

Applicable Model
S539

Drawing Title
Placement

Drawing Unit
mm

Drawing Scale
Not to scale

DRAFT
SUBJECT TO
CHANGE

Last Revised
Sept 17,2025

Drawing Version
V1.0

Page
5 of 9

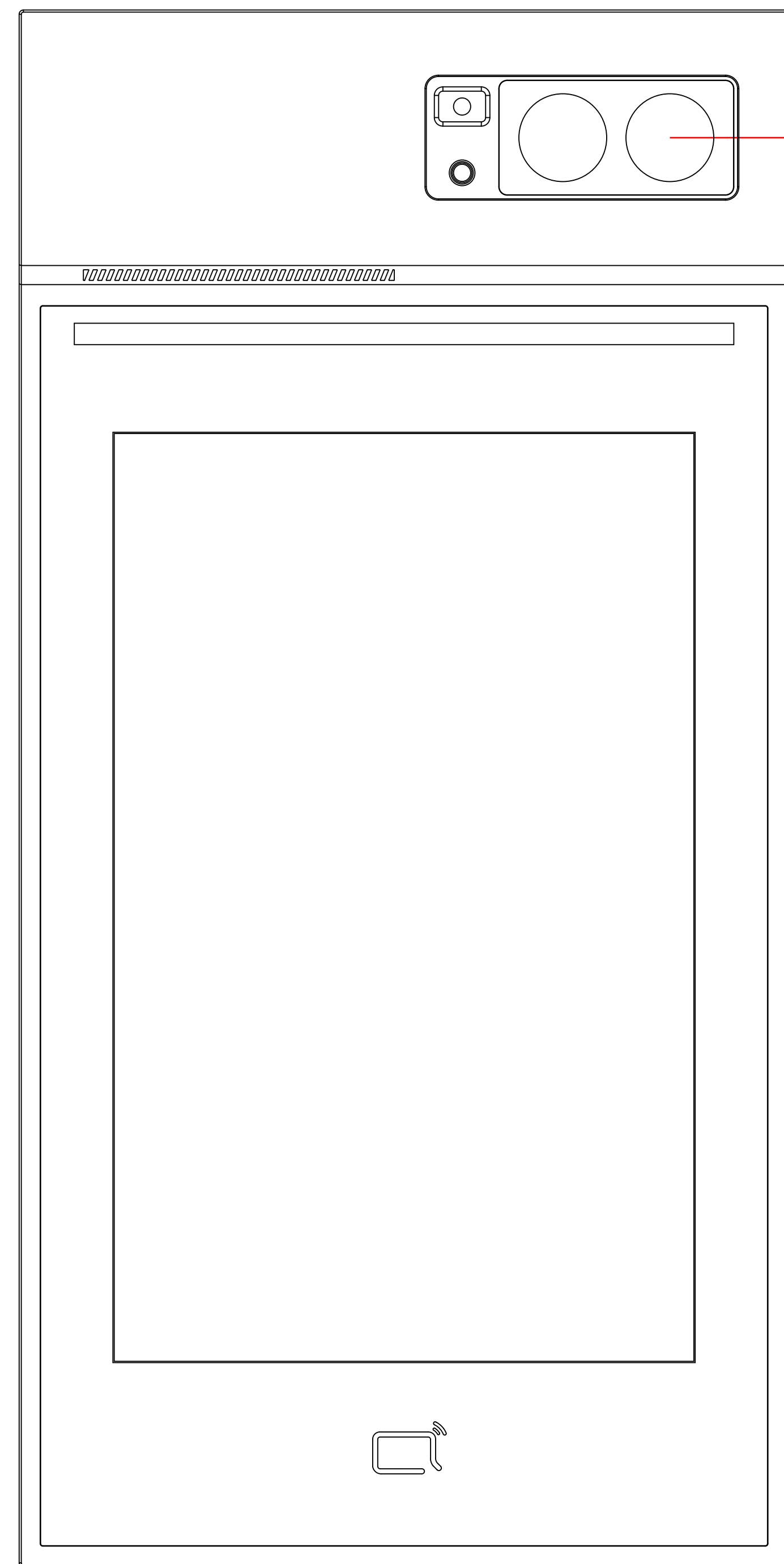

① INTERCOM PANEL FRONT VIEW

1166mm TO BOTTON OF PANEL

1500mm TO CENTER OF CAMERA

ADA Compliance Requirement

GROUND

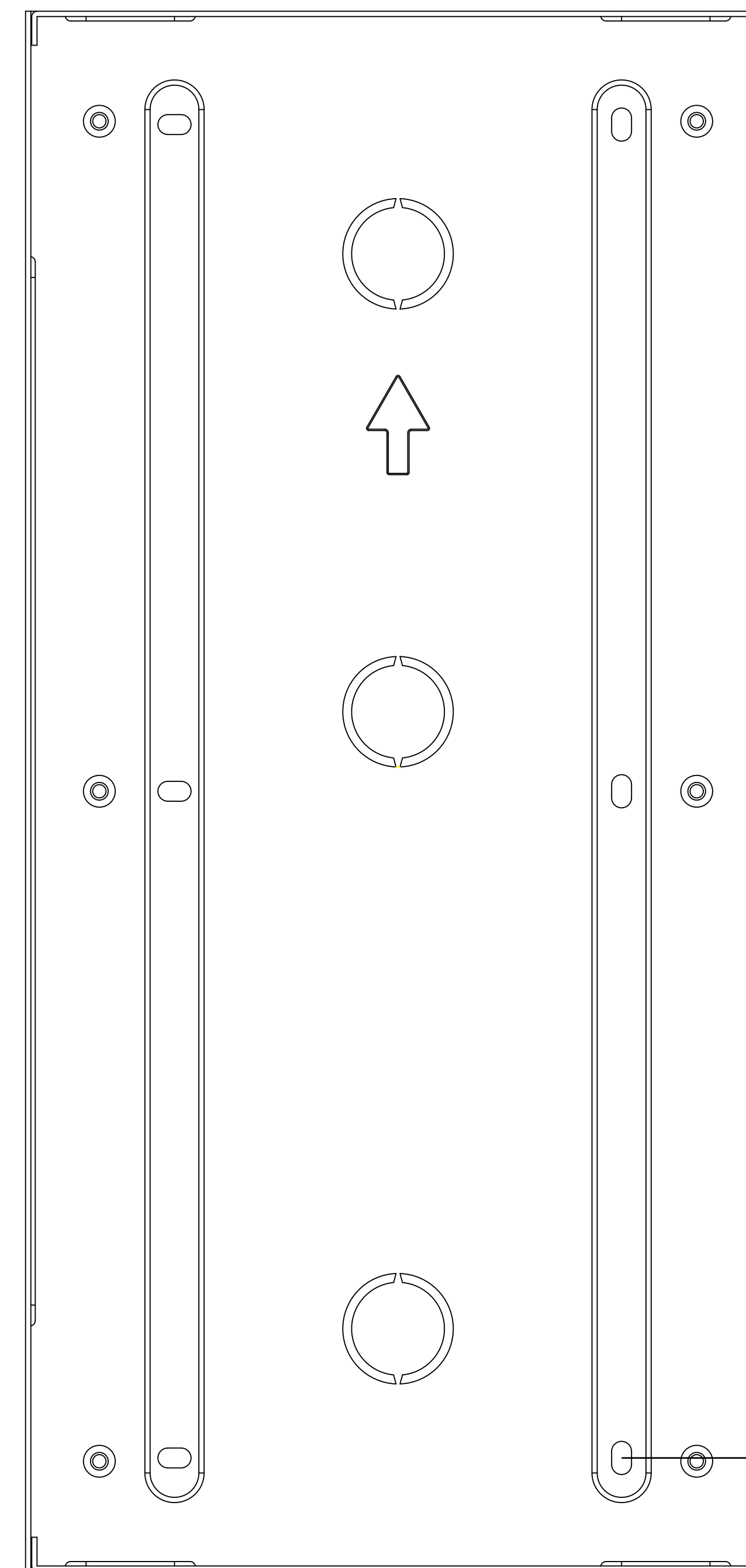

② BRACKET PLACEMENT

1172mm TO BOTTON OF BRACKET

1198mm TO SCREW HOLE CENTER OF BRACKET

GROUND

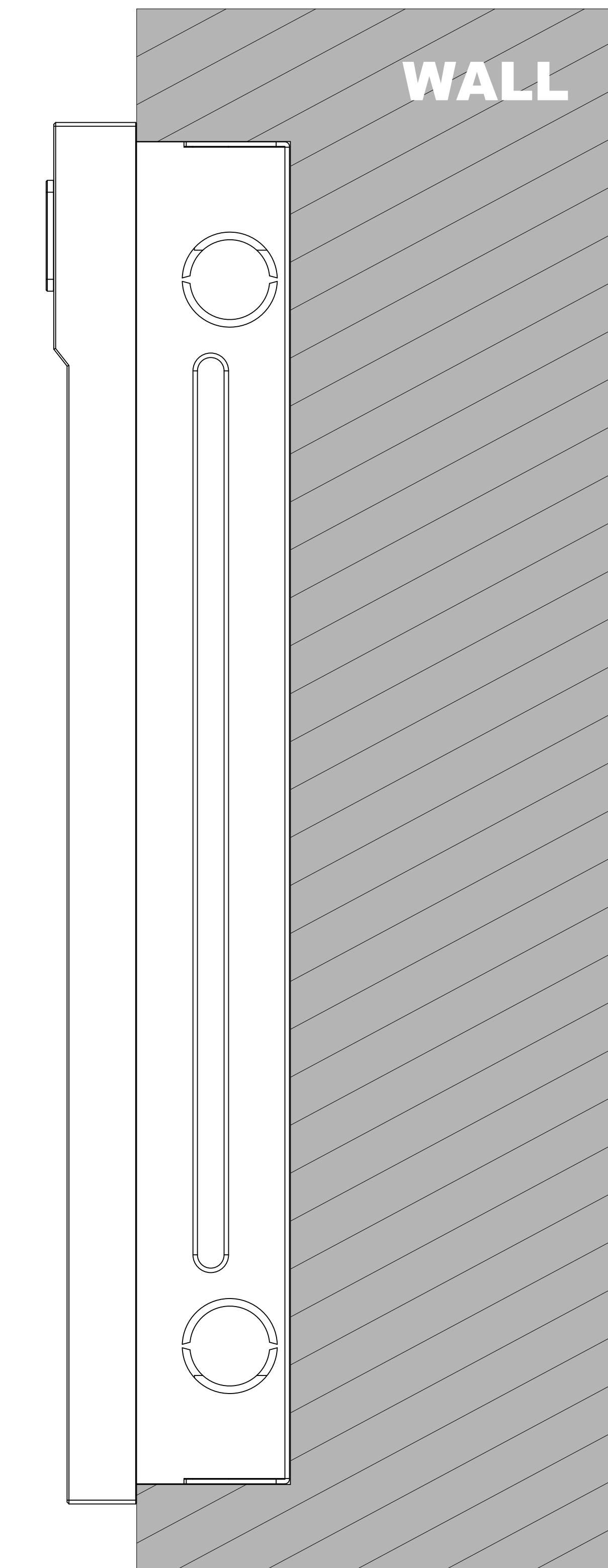

③ SIDE VIEW:INTERCOM IN WALL

WALL

Applicable Model

S539

Drawing Title

In-Wall Mounting
Rain Cover

Drawing Unit

mm

Drawing Scale

Not to scale

**DRAFT
SUBJECT TO
CHANGE**

Last Revised

Sept 17, 2025

Drawing Version

V1.0

Page

6 of 9

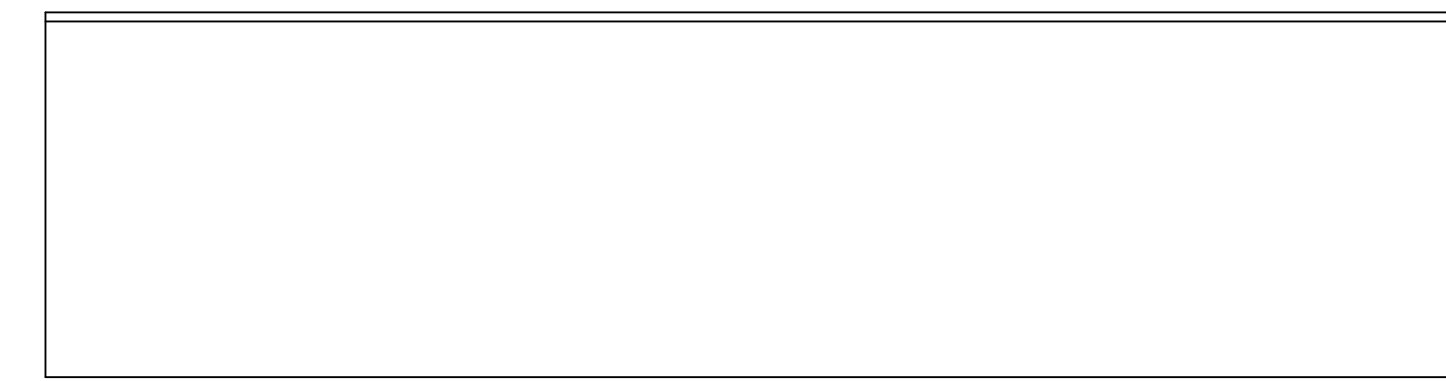

⑥ **BOTTOM VIEW**

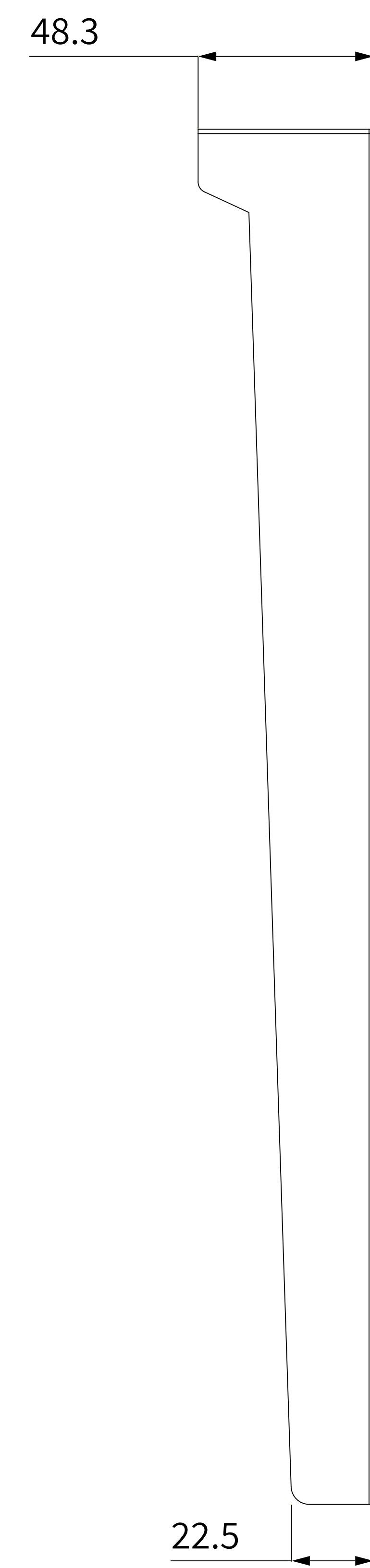

② **RIGHT VIEW**

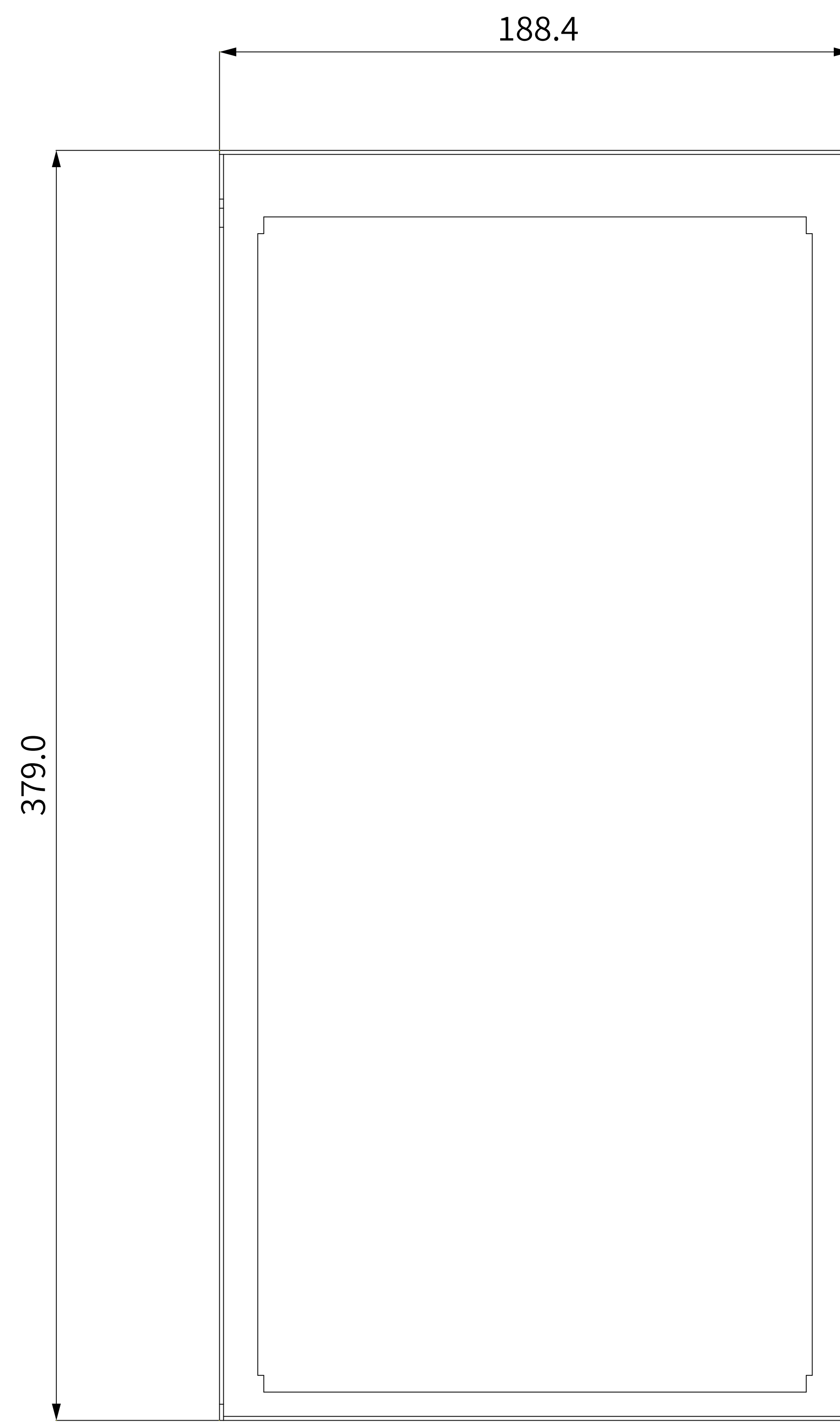

① **FRONT VIEW**

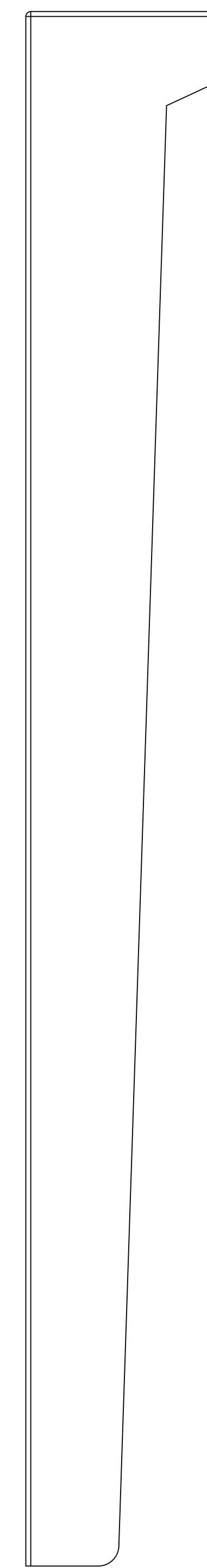

③ **LEFT VIEW**

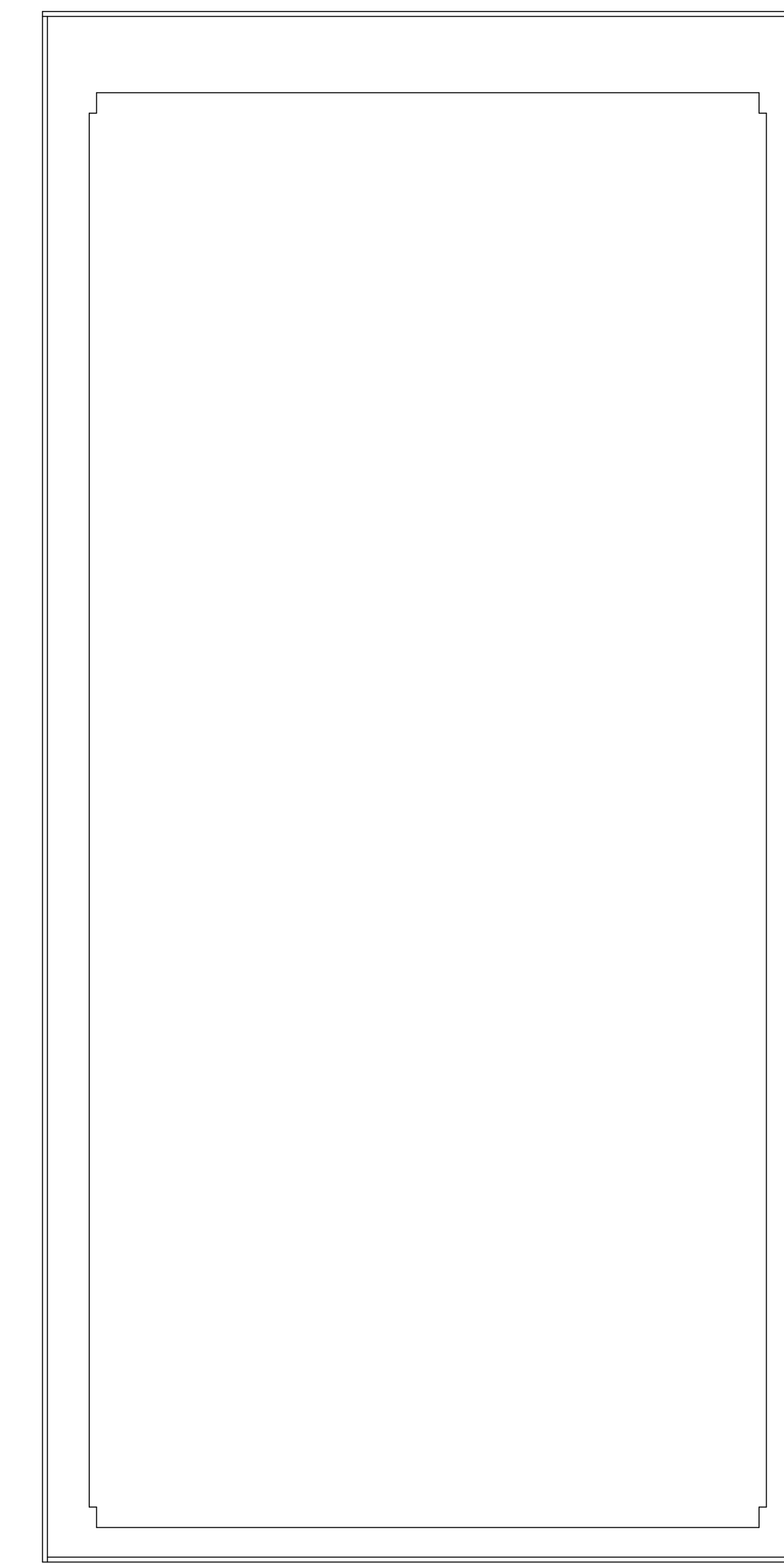

④ **BACK VIEW**



⑤ **TOP VIEW**

Applicable Model
S539

Drawing Title
Placement

Drawing Unit
mm

Drawing Scale
Not to scale

DRAFT
SUBJECT TO
CHANGE

Last Revised
Sept 17,2025

Drawing Version
V1.0

Page
7 of 9

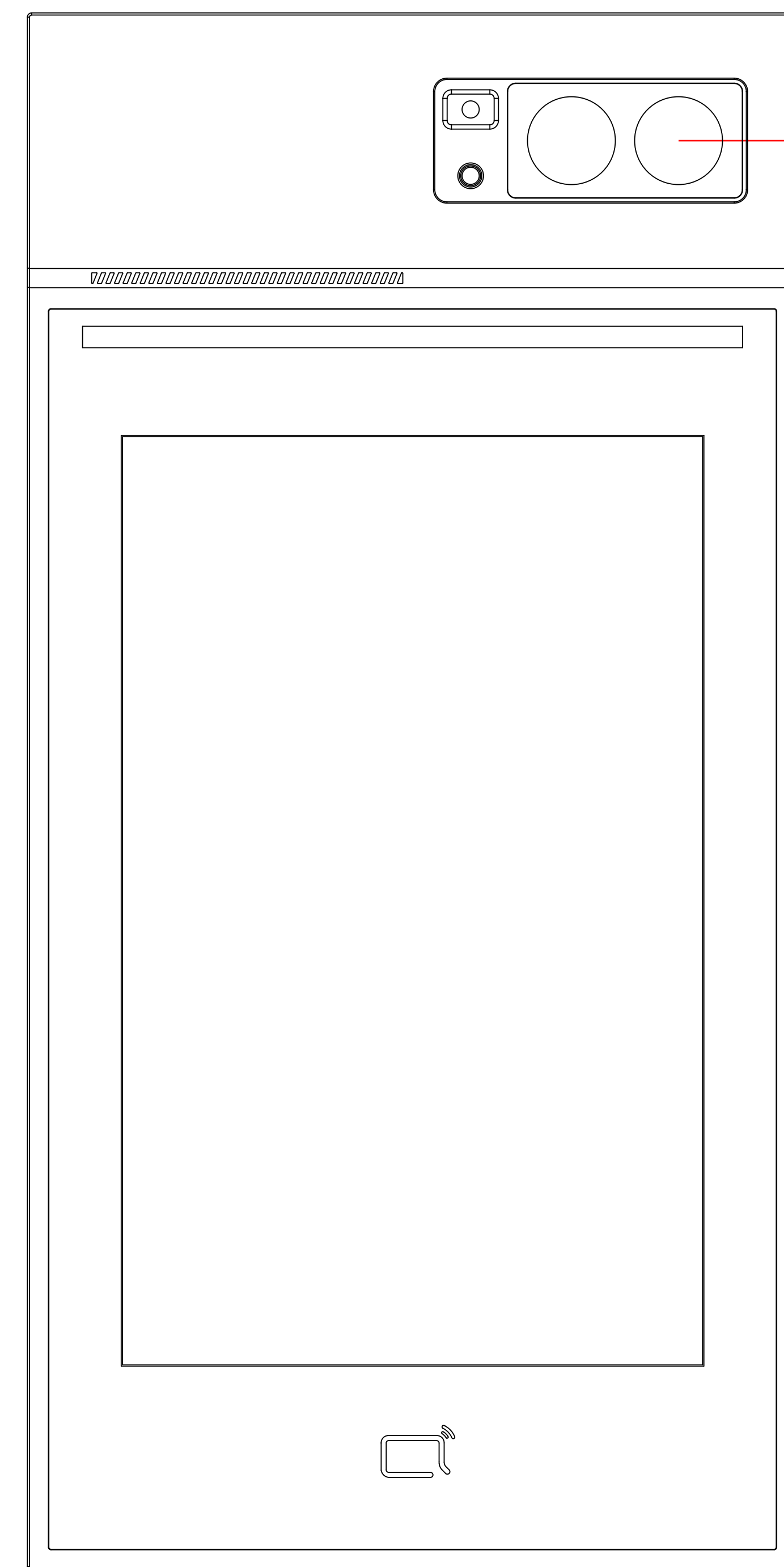

① INTERCOM PANEL FRONT VIEW

1166mm TO BOTTON OF PANEL

1500mm TO CENTER OF CAMERA

ADA Compliance Requirement

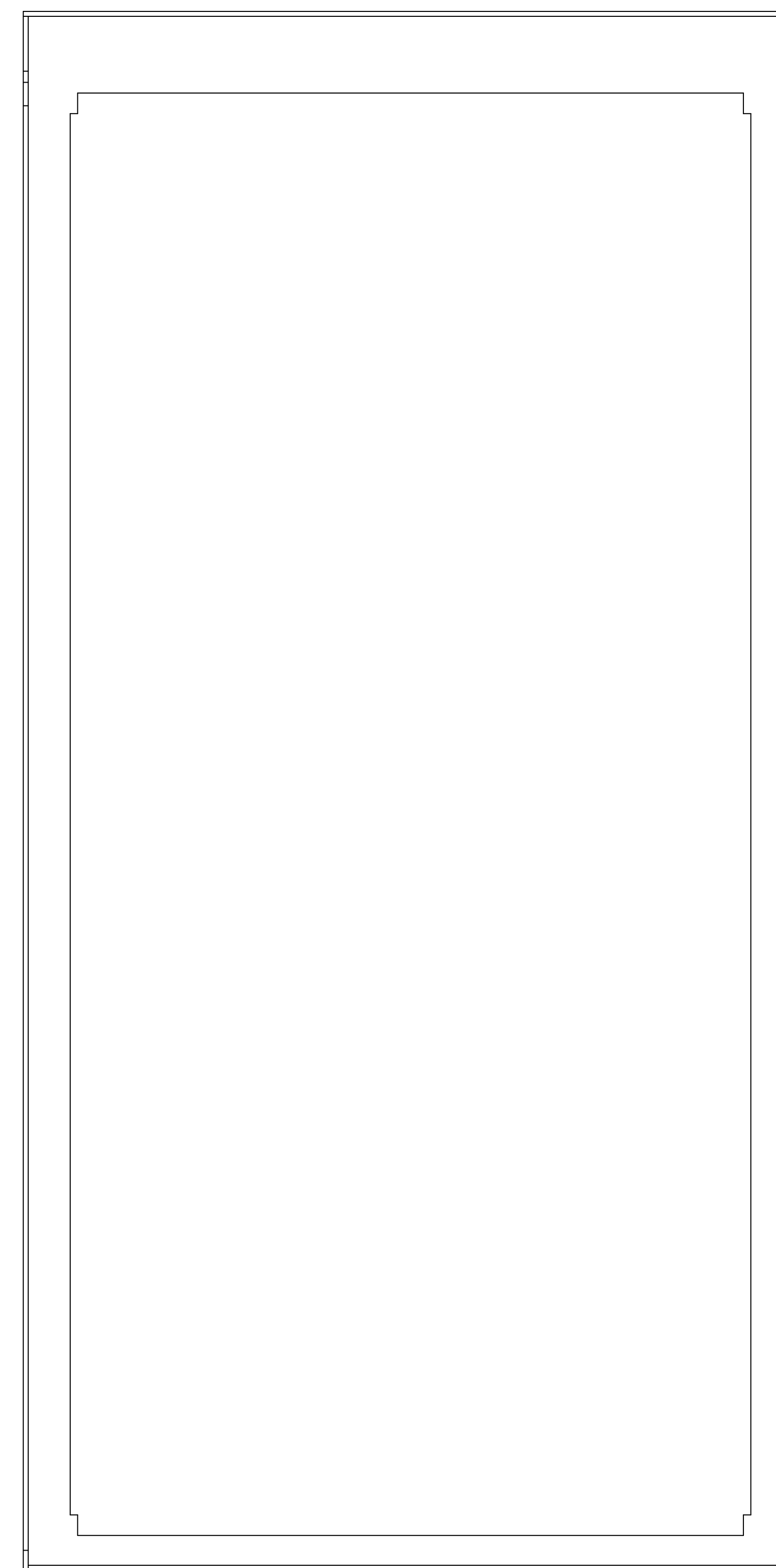
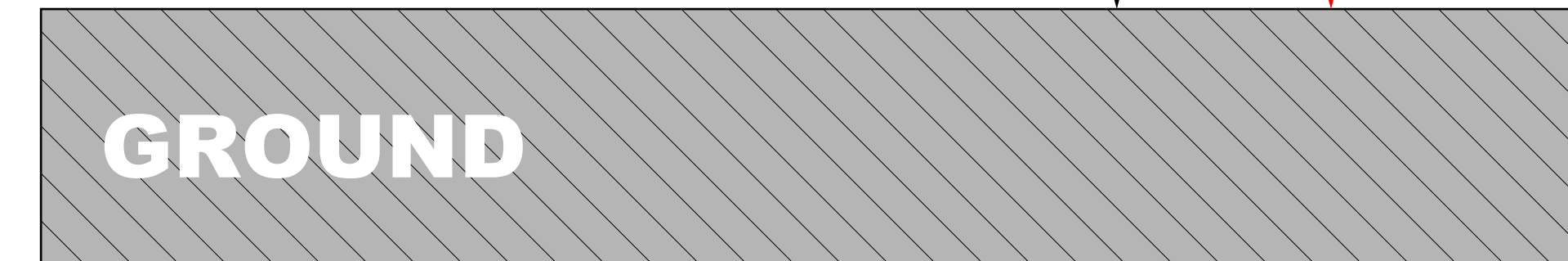

② BRACKET PLACEMENT

1164mm TO BOTTON OF BRACKET

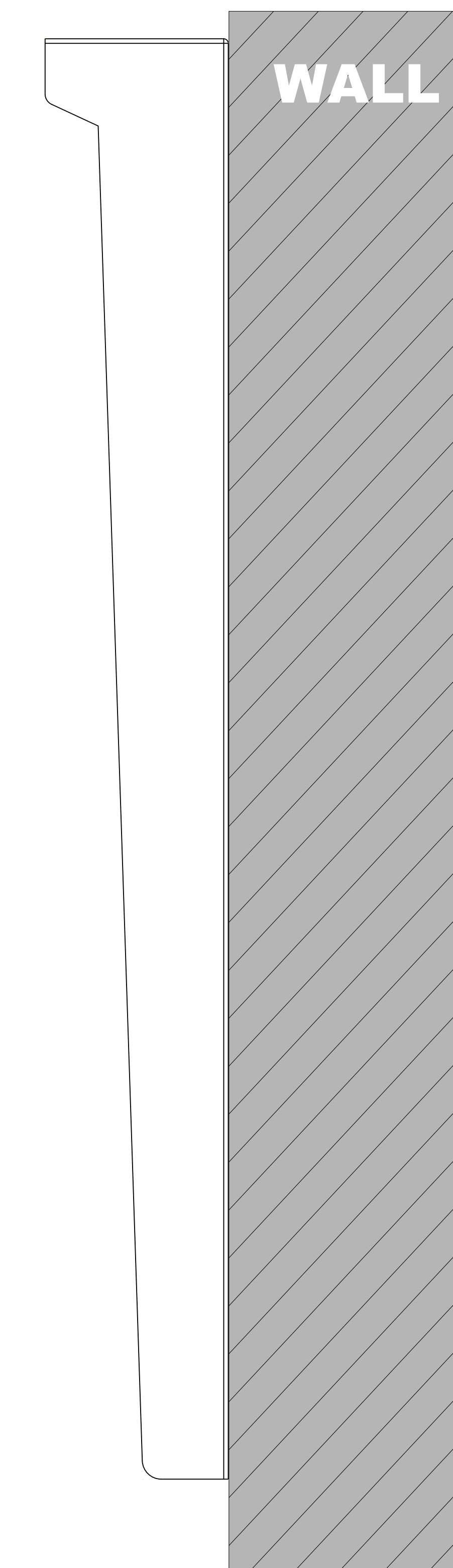
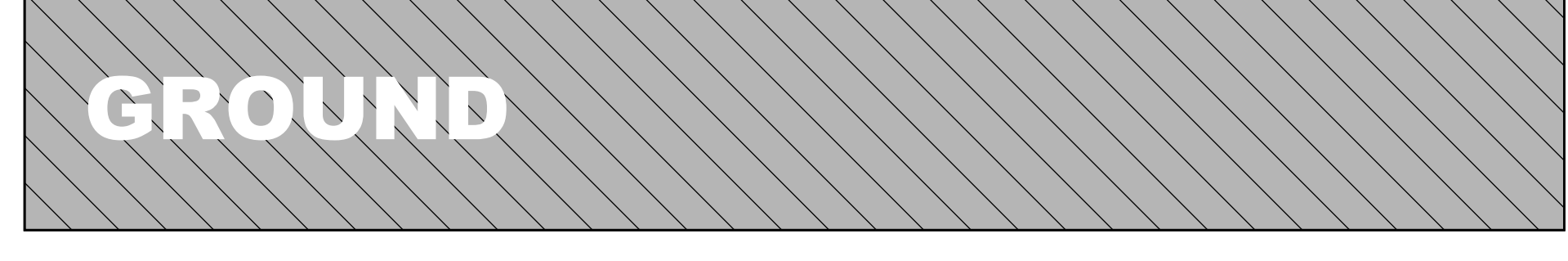

③ SIDE VIEW:INTERCOM ON WALL

Applicable Model

S539

Drawing Title

On-Wall Mounting
Rain Cover

Drawing Unit

mm

Drawing Scale

Not to scale

**DRAFT
SUBJECT TO
CHANGE**

Last Revised

Sept 17, 2025

Drawing Version

V1.0

Page

8 of 9

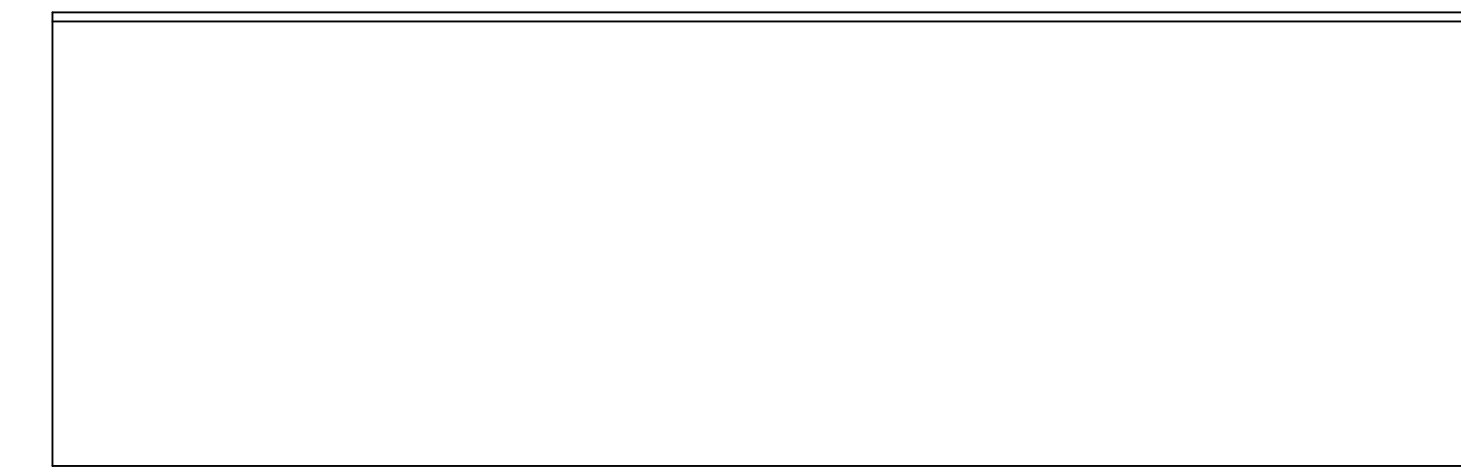

⑥ **BOTTOM VIEW**

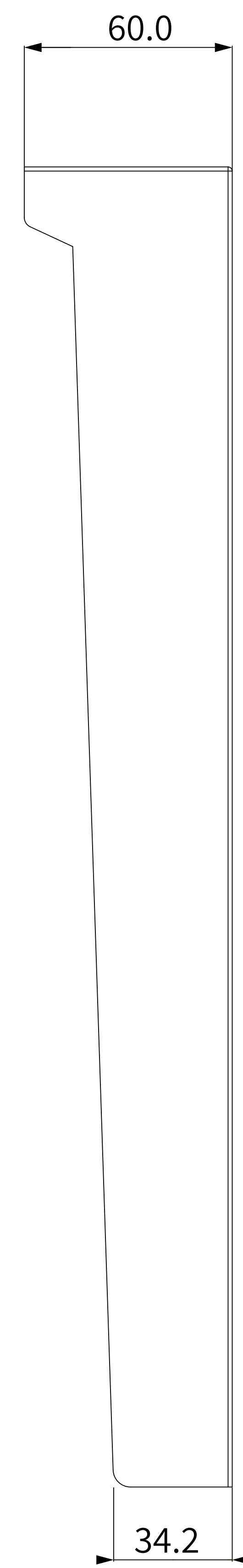

② **RIGHT VIEW**

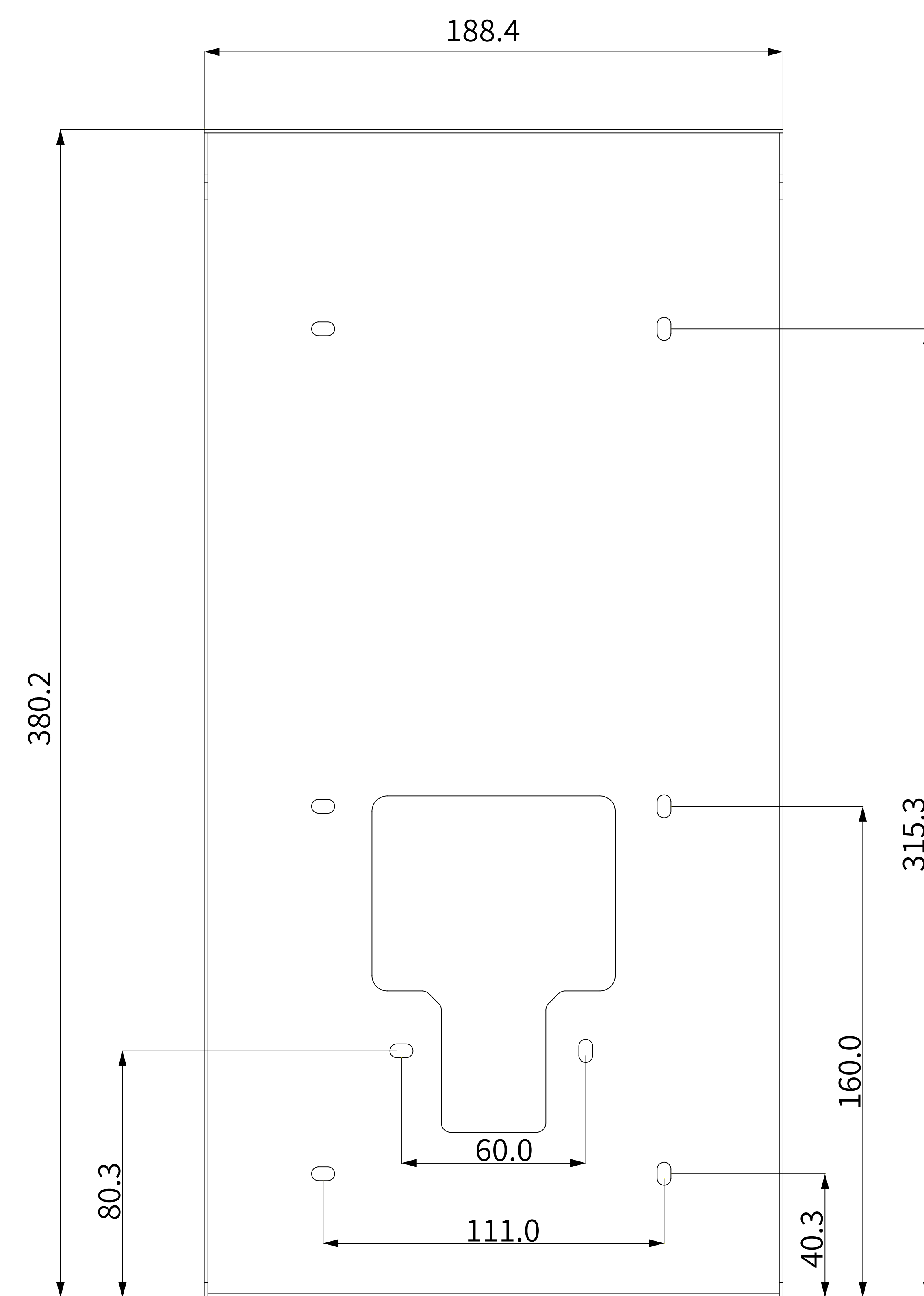

① **FRONT VIEW**

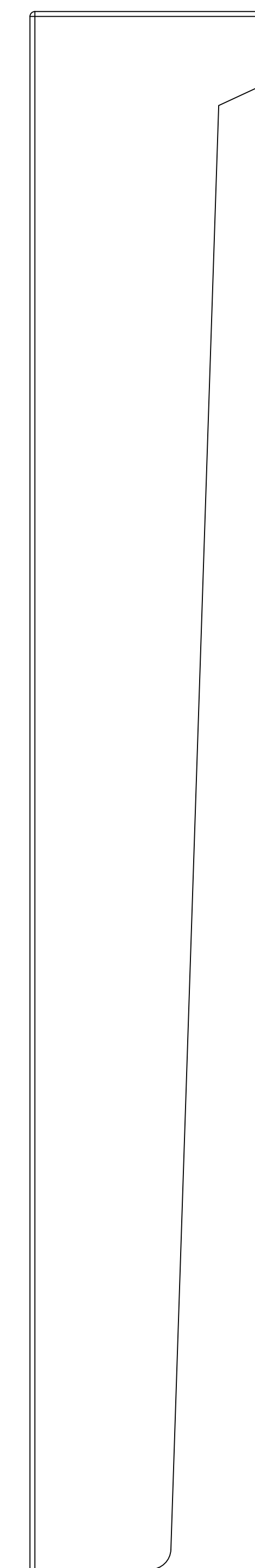

③ **LEFT VIEW**

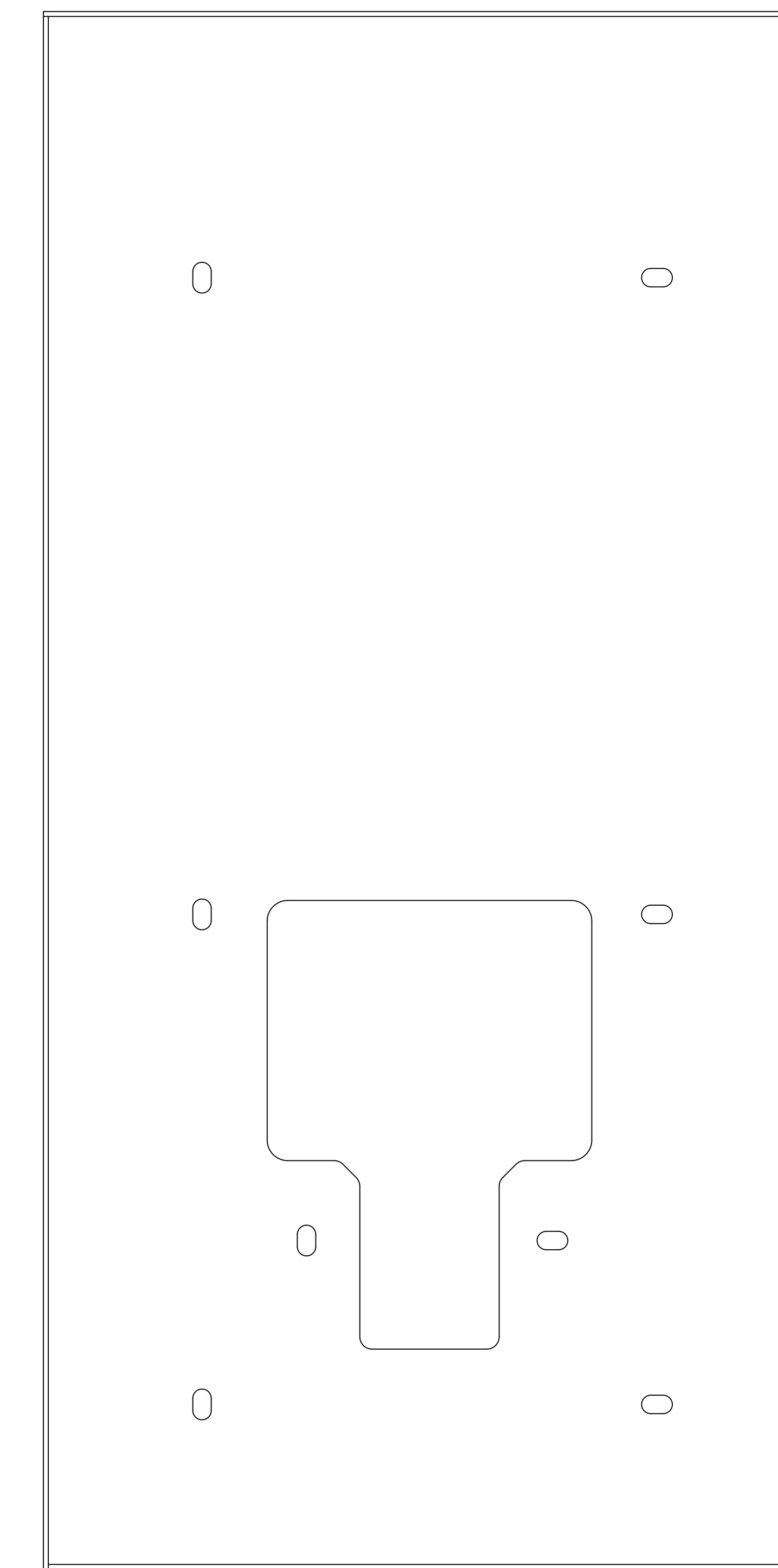

④ **BACK VIEW**

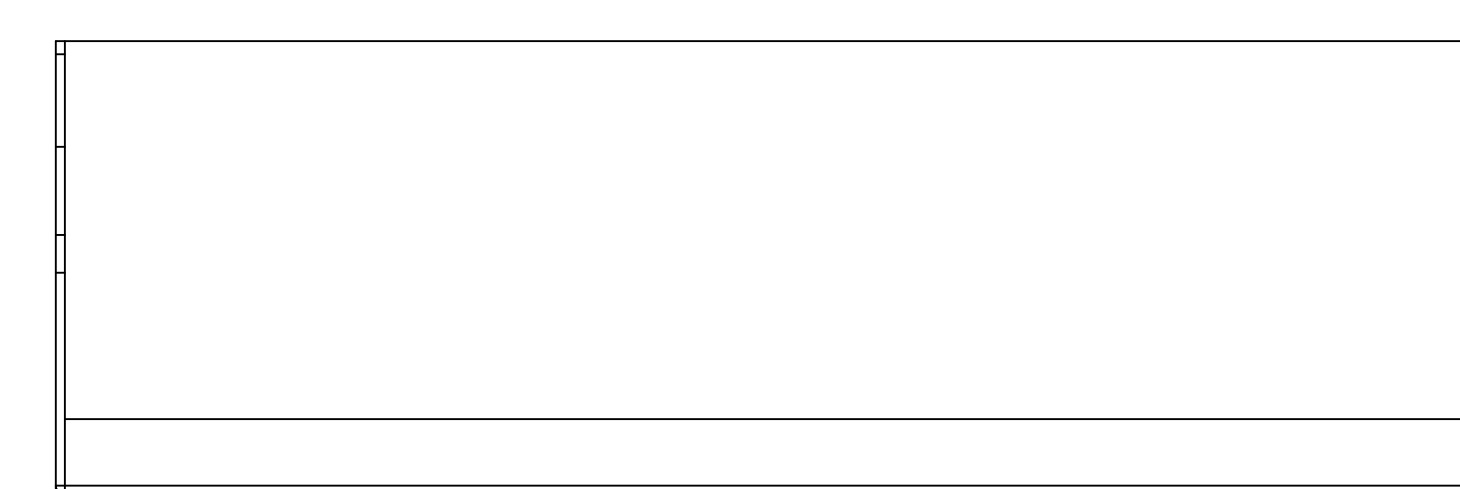

⑤ **TOP VIEW**

Applicable Model
S539

Drawing Title
Placement

Drawing Unit
mm

Drawing Scale
Not to scale

DRAFT
SUBJECT TO
CHANGE

Last Revised
Sept 17,2025

Drawing Version
V1.0

Page
9 of 9

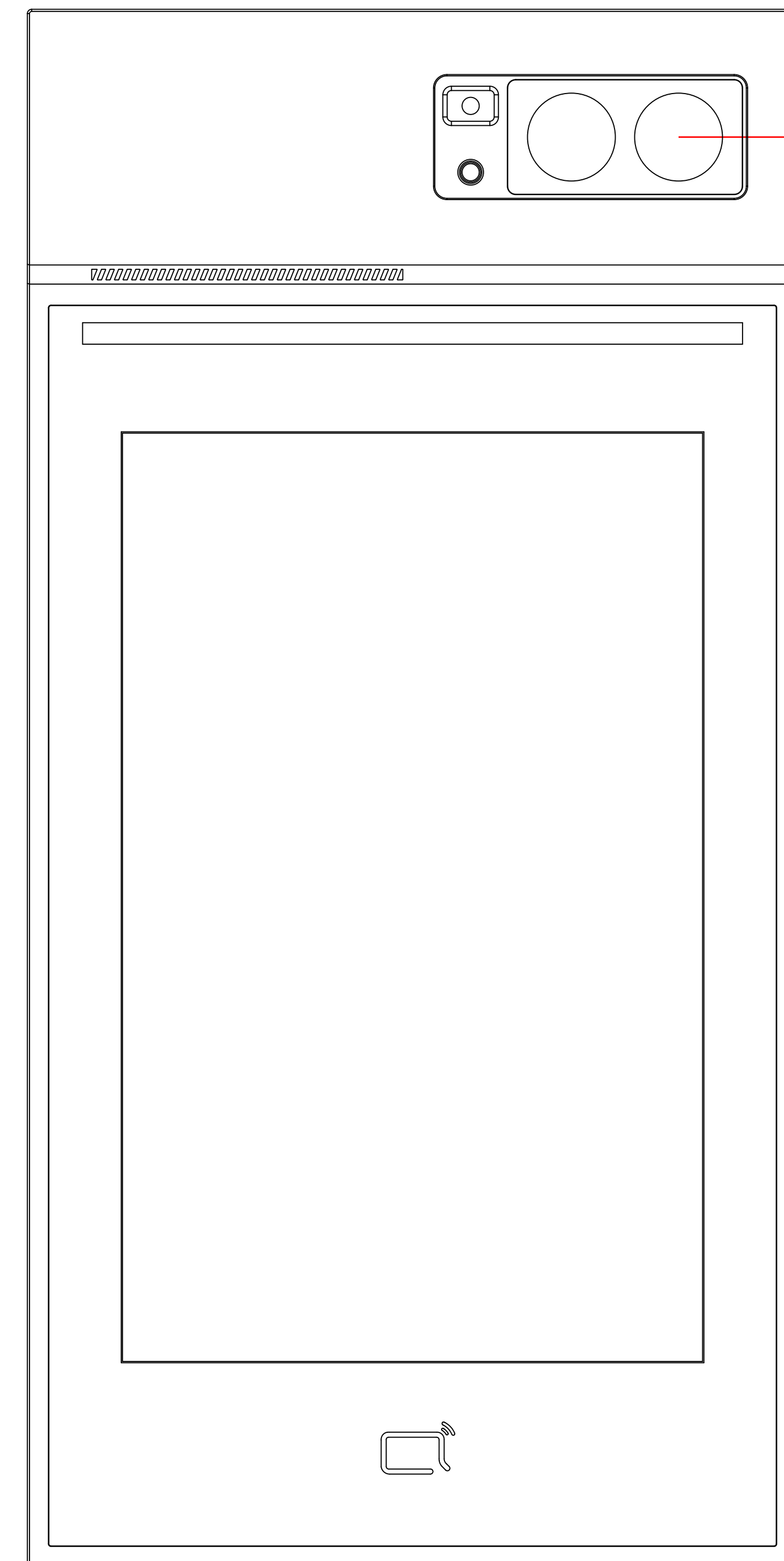

① INTERCOM PANEL FRONT VIEW

1166mm TO BOTTON OF PANEL

1500mm TO CENTER OF CAMERA

ADA Compliance Requirement

GROUND

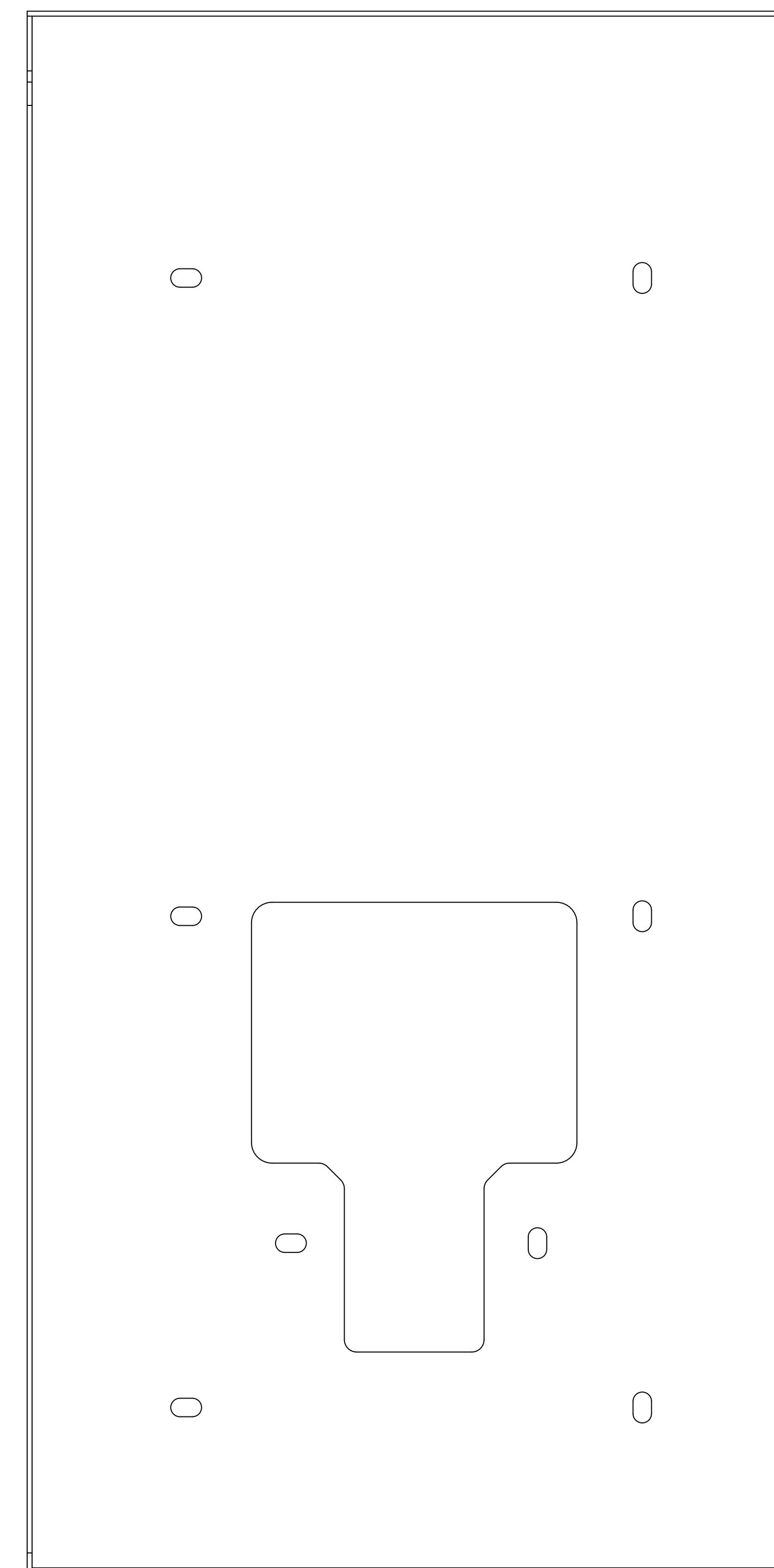

② BRACKET PLACEMENT

1162.5mm TO BOTTON OF BRACKET

GROUND

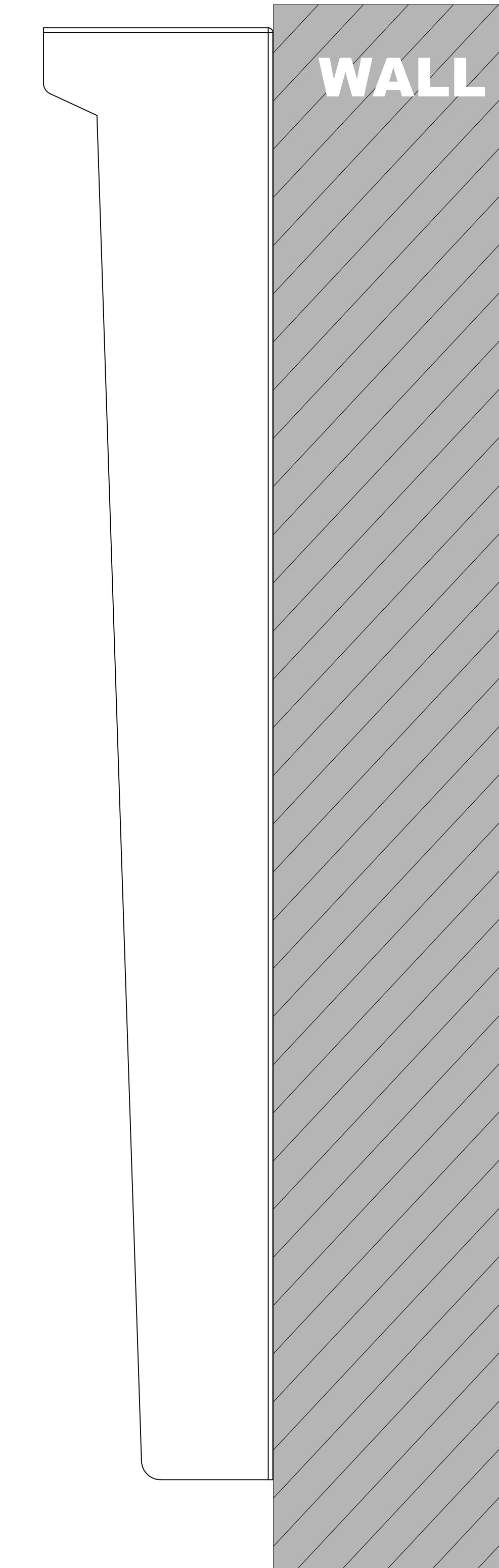

③ SIDE VIEW:INTERCOM ON WALL