



Htek IP Phones UC912G User Manual



Version 2.0.4.4.29
Mar. 2018

Notices Information

Copyright

Copyright © 2005 - 2018 Nanjing Hanlong Technology CO., LTD. All rights reserved.

Nanjing Hanlong Technology Co., LTD. owns all the rights to modify and copy this document at any time. And all the illustrations and text in this document are copyright protected. Therefore, no parts of this document may be used or reproduced, transmitted by the third parties for any purposes without the express written permission of Nanjing Hanlong Technology CO., LTD.

When this document is made available on www.htek.com, Nanjing Hanlong Technology Co., LTD. gives its right to download and print copies of this content only for private use as a user manual. No parts shall have the right to alter, modify or use as commercial means without prior written permission from Nanjing Hanlong Technology Co., LTD.

Safety Instructions

- To use the Phone, please follow the instructions in this user manual.
- Use the power adapter supplied with your phone. Other power adapters may damage the phone.
- This phone is only for indoor use. And also avoid in high humidity, water and some other liquids.
- Do not use the phone during thunderstorms.
- CE
- FCC

WEEE Warning



To avoid the potential effects on the environment and human health as a result of the presence of hazardous substances in electrical and electronic equipment, end users of electrical and electronic equipment should understand the meaning of the crossed-out wheeled bin symbol. Do not dispose of WEEE as unsorted municipal waste and have to collect such WEEE separately.

Cleaning

To clean the device, use an anti-static cloth. Please avoid cleaning liquids as they might damage the surface or internal electronics of the phone.

FCC Statement

1. This device complies with Part 15 of the FCC Rules. Operation is subject to the following two conditions:

(1) This device may not cause harmful interference.

(2) This device must accept any interference received, including interference that may cause undesired operation.

2. Changes or modifications not expressly approved by the party responsible for compliance could void the user's authority to operate the equipment.

NOTE: This equipment has been tested and found to comply with the limits for a Class B digital device, pursuant to Part 15 of the FCC Rules. These limits are designed to provide reasonable protection against harmful interference in a residential installation.

This equipment generates uses and can radiate radio frequency energy and, if not installed and used in accordance with the instructions, may cause harmful interference to radio communications. However, there is no guarantee that interference will not occur in a particular installation. If this equipment does cause harmful interference to radio or television reception, which can be determined by turning the equipment off and on, the user is encouraged to try to correct the interference by one or more of the following measures:

- Reorient or relocate the receiving antenna.

- Increase the separation between the equipment and receiver.

- Connect the equipment into an outlet on a circuit different from that to which the receiver is connected.

- Consult the dealer or an experienced radio/TV technician for help.

Summary of changes

This section describes the changes to this user manual for each release and user manual version.

Change for Release x.0.4.4.27, Manual version x.0.4.4.27

Major updates have occurred to the following sections:

- UC912G supports 4 accounts

Change for Release x.0.4.0.10, Manual version x.0.4.0.10

Major updates have occurred to the following sections:

- [Label Scroll](#)

Change for Release x.0.4.0, Manual version x.0.4.0

Major updates have occurred to the following sections:

- [IPv6](#)
- [IPv4&IPv6](#)

Change for Release x.0.3.98.O, Manual version x.0.3.98.O

Major updates have occurred to the following sections:

- [Reboot in Talking](#)

Change for Release x.0.3.98.A, Manual version x.0.3.98.A

Major updates have occurred to the following sections:

- [Auto Logout Time](#)

Change for Release x.0.3.98, Manual version x.0.3.98

Major updates have occurred to the following sections:

- [Daylight Saving Time](#)

Change for Release x.0.3.93, Manual version x.0.3.93

Major updates have occurred to the following sections:

- [Check-Syn With Authenticate](#)
- [Call Back](#)

Change for Release x.0.3.88, Manual version x.0.3.88

Major updates have occurred to the following sections:

- [Detect IP Conflict](#)

Change for Release x.0.3.72, Manual version x.0.3.72

Major updates have occurred to the following sections:

- [Voice Mail Tone](#)
- [Backup NTP Server](#)
- [Intercom Barge](#)

Change for Release x.0.3.65, Manual version x.0.3.65

Major updates have occurred to the following sections:

- [Redial Mode](#)

Change for Release x.0.3.63, Manual version x.0.3.63

Major updates have occurred to the following sections:

- [Suppress DTMF Display](#)
- [Suppress DTMF Display Delay](#)

Change for Release x.0.3.62, Manual version x.0.3.62

Major updates have occurred to the following sections:

- [Auto Redial](#)

Table of Content

Notices Information	2
Copyright.....	2
Safety Instructions.....	2
WEEE Warning	2
Cleaning.....	3
FCC Statement.....	3
Summary of changes.....	4
Change for Release x.0.4.4.27,Manual version x.0.4.4.27	4
Change for Release x.0.4.0.10,Manual version x.0.4.0.10	4
Change for Release x.0.4.0,Manual version x.0.4.0.....	4
Change for Release x.0.3.98.O,Manual version x.0.3.98.O.....	4
Change for Release x.0.3.98.A,Manual version x.0.3.98.A	4
Change for Release x.0.3.98,Manual version x.0.3.98.....	4
Change for Release x.0.3.93,Manual version x.0.3.93.....	5
Change for Release x.0.3.88,Manual version x.0.3.88.....	5
Change for Release x.0.3.72,Manual version x.0.3.72.....	5
Change for Release x.0.3.65,Manual version x.0.3.65.....	5
Change for Release x.0.3.63,Manual version x.0.3.63.....	5
Change for Release x.0.3.62,Manual version x.0.3.62.....	5
Table of Content.....	6
Getting Started	10
Packing List.....	10
Phone Installation.....	12
1. Attach the Foot stand.....	12
2. Connect the Handset and optional Headset.....	12
3. Connect the Network and Power	13
Initialization	13
Status.....	14
Registration.....	15
Idle Screen.....	18
Getting Familiar with Your Phone.....	19
Hardware Components Preview	19
Icon Preview.....	21
LED Instruction.....	22
Power Indicator LED.....	23
Line LED:(Line Key set as Line)	23
BLF or BLF List Key LED :(Line Key set as BLF).....	23
Shared Line Key LED:.....	23
Other Key Led.....	24
User Interface.....	25
Line Key Function Overview.....	26

Basic Features Configuration	29
General Settings.....	29
Web Login.....	29
Administrator Password.....	30
Language	31
Screen Saver	31
Gray Level.....	33
Time and Date.....	33
LED Status Setting	38
Key as Send.....	38
Network Setting.....	39
IPv4	39
IPv6.....	41
IPv4&IPv6	43
PC Port	44
Contact Settings.....	46
Local Directory	46
Remote Phonebook.....	50
LDAP Phonebook.....	50
Search Contact.....	52
Call History Settings	53
Call History.....	53
Audio settings.....	56
Ring Tone.....	56
Volume	58
Voice Mail Tone	59
Play Hold Tone	59
Play Hold Tone Delay	60
System Settings	60
Dial Plan.....	60
Dial-Now Timeout	61
No Key Entry Timeout.....	62
Emergency Call.....	62
Label Scroll	63
Show Missed Calls	63
Auto Logout Time	64
Reboot in Talking.....	64
Detect IP Conflict.....	64
Redial Mode	64
Keypad Lock	65
Suppress DTMF Display.....	66
Suppress DTMF Display Delay.....	66
Check-Syn With Authenticate	66
Other features settings	67

Action URL	67
Softkey Layout.....	68
Programmable Key.....	69
Basic Call Features	70
Place a Call.....	70
End a Call	71
Receive a Call.....	72
Incoming Call Show Mode	72
Auto Answer	73
Call Hold	74
Call Transfer.....	74
Call Conference.....	77
Call Forward.....	78
Call Return.....	81
Call Back.....	82
Call Waiting Tone.....	82
Hide Caller ID	83
Reject Anonymous	84
Call Mute.....	84
DND	85
Hot Line.....	85
Auto Redial.....	86
Function Keys Features Settings.....	86
Line.....	86
Speed Dial.....	87
BLF	88
BLF List.....	89
Voice Message.....	90
Direct Pickup.....	92
Group Pickup	93
Call Park	94
Intercom.....	95
Intercom Barge.....	96
DTMF.....	97
Prefix.....	98
Local Group.....	99
XML Group.....	100
LDAP	101
XML Browser.....	101
Broadsoft Group.....	102
Conference.....	103
Forward.....	104
Transfer.....	104
Hold	105

Group Listening.....	106
DND	106
Redial.....	107
SMS	107
Send SMS	107
Set SMS Line Key	108
Record	109
URL Record	110
Paging.....	110
Shared Line.....	111
Public Hold	112
Private Hold.....	113
Hot Desking.....	114
ACD	115
Zero Touch.....	116
Multicast Paging.....	117
Sending RTP Stream.....	117
Receiving RTP Stream	118
Upgrade	120
Factory Reset.....	120
Pcap Feature.....	120
System Log	121
Upgrade	121
Configuration File	124
Troubleshooting.....	125
Why is the phone LCD screen blank?.....	125
Why does the phone display "Network Unavailable"?	125
Why can't I get a dial tone?	126
Where to set the tone?	126
How to download XML Configuration?.....	126
How to Import Trusted CA certificate?.....	127
How to Import Server CA certificate?.....	127
How to use Vlan?	128
How to use LLDP?	128
How to Set LCD and Web GUI?	128
How to Upgrade via FTP?	128
How to make Ringtone?	128
How to use Open VPN?	128
Provisioning Guide on Free PBX	128
Redundancy Server.....	129
How to Use Auto Provision Phonebook?.....	129
All Documents	129

Getting Started

Packing List

The package contains the following parts, please check if all the items are not missed:

1. The phone device

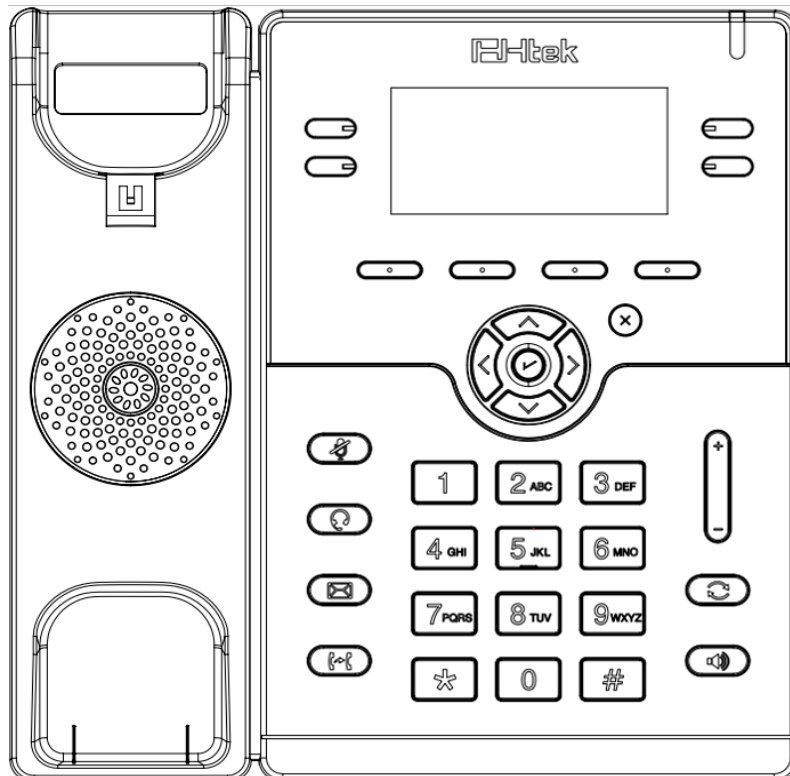

2. The footstand

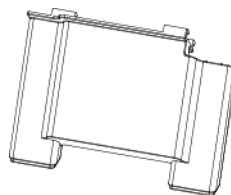

3. Handset

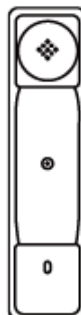

4. Headset cord

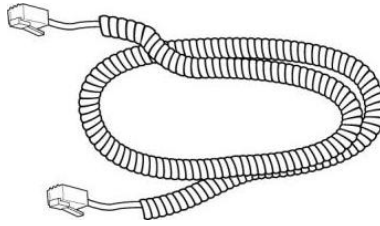

5. Power adapter

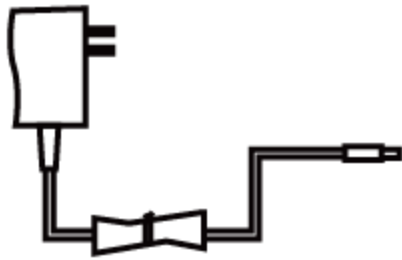

6. Ethernet cable

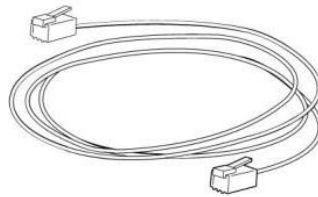

7. Quick installation reference

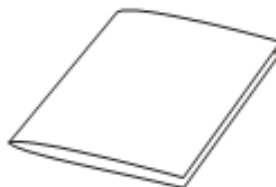

Phone Installation

1. Attach the Foot stand

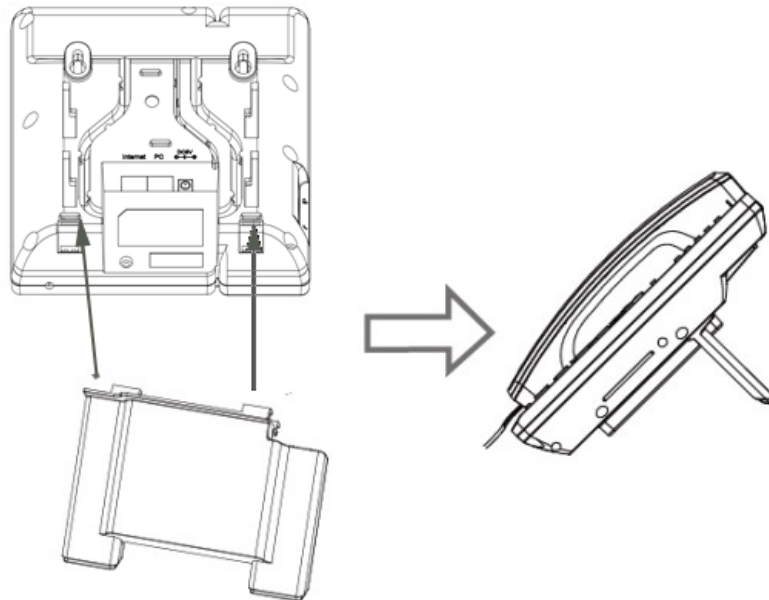

2. Connect the Handset and optional Headset

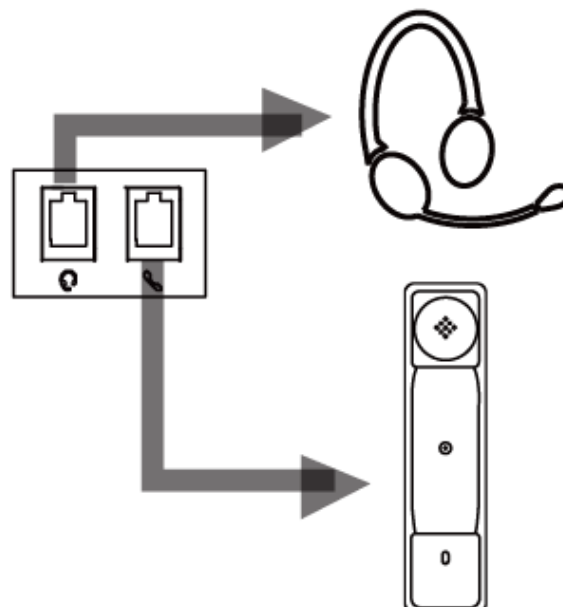

3. Connect the Network and Power

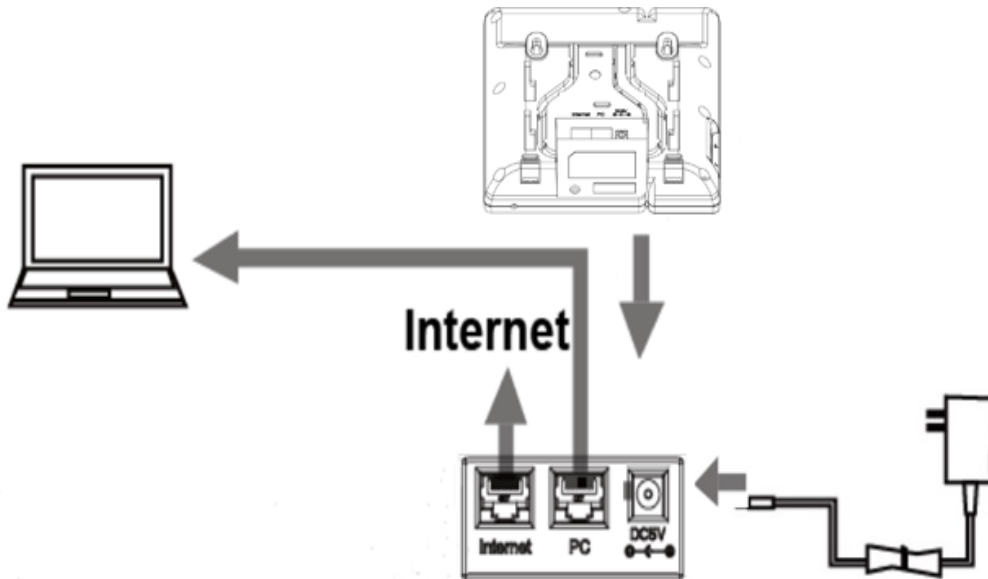

Initialization

After your phone has been powered up, the system boots up and performs the following steps:

Automatic Phone Initialization

The phone finishes the initialization process by loading the saved configuration. The phone LCD screen will display "Booting"

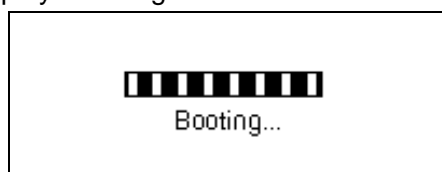

And then show "Initializing" during the initialization.

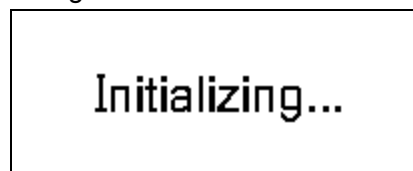

The IP Phone will upgrade the firmware if there is a new firmware on your server. And the IP Phone will show "Check firmware, please waiting..." after initialization.

**Check firmware
Please wait**

Then IP Phone will show Reboot information:

Device Reboot Please wait...

By default the phone attempts to contact a DHCP server in your network in order to obtain its valid network settings, e.g. IP address, subnet mask, default gateway, DNS server.

Status

You can view the system status of your phone via phone user interface or web user interface. The information of phone status includes: Information(e.g., Model, IP, MAC, Firmware, Hardware), Network(e.g., WAN Type, IP, Mask, LAN Type, Gateway, DNS...)Account (e.g., register status of accounts)

To view the phone status via phone interface:

1. Press Menu →Status →Information

```
1.Model:UC912G
2.IPV4:192.168.1.224
3.IPV6:2015:f4c1:1111:1111:f42c:2897:77..
Back
```

2. Press Menu →Status →Network

```
1.IPV4
2.IPV6
3.IP Port Mode:IPV4&IPV6
Back Enter
```

3. Press Menu →Status →Network→IPV4

```
1.WAN:DHCP mode
2.IP:192.168.1.224
3.Mask:255.255.252.0
Back
```

4. Press Menu →Status →Network→IPV6

```
1.WAN:DHCP mode
2.IP:2015:f4c1:1111:1111:f42c:2897:7747..
3.Gate way:/64
Back
```

5. Press Menu →Status →Accounts (UC912G support four accounts).

```
1.529:Registered
2.Empty:Not Registered
3.Empty:Not Registered
Back
```

To view the phone status via Web interface:

1. Login webpage (For How to login, please refer to [Web Login](#))
2. View the information of Version, Account and Network.

Status

- Version**

Product Model	UC912G
Firmware Version	BOOT--2.0.4.4(2018-01-20 13:34:00) IMG--2.0.4.4.29(2018-03-05 08:38:00) ROM--2.0.4.4.29(2018-03-05 08:38:00) DSP--9.0.3(Patch 1.0.16)
- Account Status**

Account1	Registered
Account2	Disabled
Account3	Disabled
- Network**

IP Mode (IPv4/IPv6)	IPv4 & IPv6
Device Type	Bridge
MAC Address	00:1f:c1:1c:a2:90
- IPv4 Setting**

WAN Port Type	DHCP
WAN IP Address	192.168.1.224
Subnet Mask	255.255.252.0
Gateway	192.168.0.2
Primary DNS	192.168.0.2
Secondary DNS	
- IPv6 Setting**

WAN Port Type	DHCP
WAN IP Address	2015:1fc1:1111:1111:f42c:2897:7747:b860/64
Gateway	::64

NOTE

Version:
Shows product type and the version of firmware.

Account Status:
Shows the registered status of accounts.

Network:
Shows the detail information of WAN port and LAN port.

System Up Time:
Shows the running time after device power up.

Restart:
Restart the voip application

Registration

To register via phone interface:

1. Press Menu→ Settings→ Advanced setting (default password: admin)→ Accounts.
2. Select the desired account
3. Select Enable for Account active
4. Select the desired profile of the account.
5. Fill the SIP User ID, Authenticate ID
6. Fill the Password and Name (shown on LCD).
7. Press Save to save the configuration.

```

1.Account Active:On
2.Account Active:Profile 1
3.SIP UserID: 529
    
```

Cancel INFO Switch Save

Note:

If there is a port of sip server, you need to press “1” on the keypad, then you will find the “.”.

Additional Information:

When the current input method is ABC/abc/2ab,

Pressing “1”, you will find “, . ?:;”

Pressing “0”, you will find “ < > () { } [] ”

Pressing “*”, you will find “*!@#\$”

Pressing “#”, you will find “#%&*|”

To register via web interface:

1. Login Web interface and Click Profile→ Basic.

2. Fill the Primary SIP Server and other profile information.

3. Select the SIP Transport.

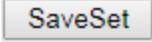
4. Click  to save the configuration.
5. Click Account→ Basic.

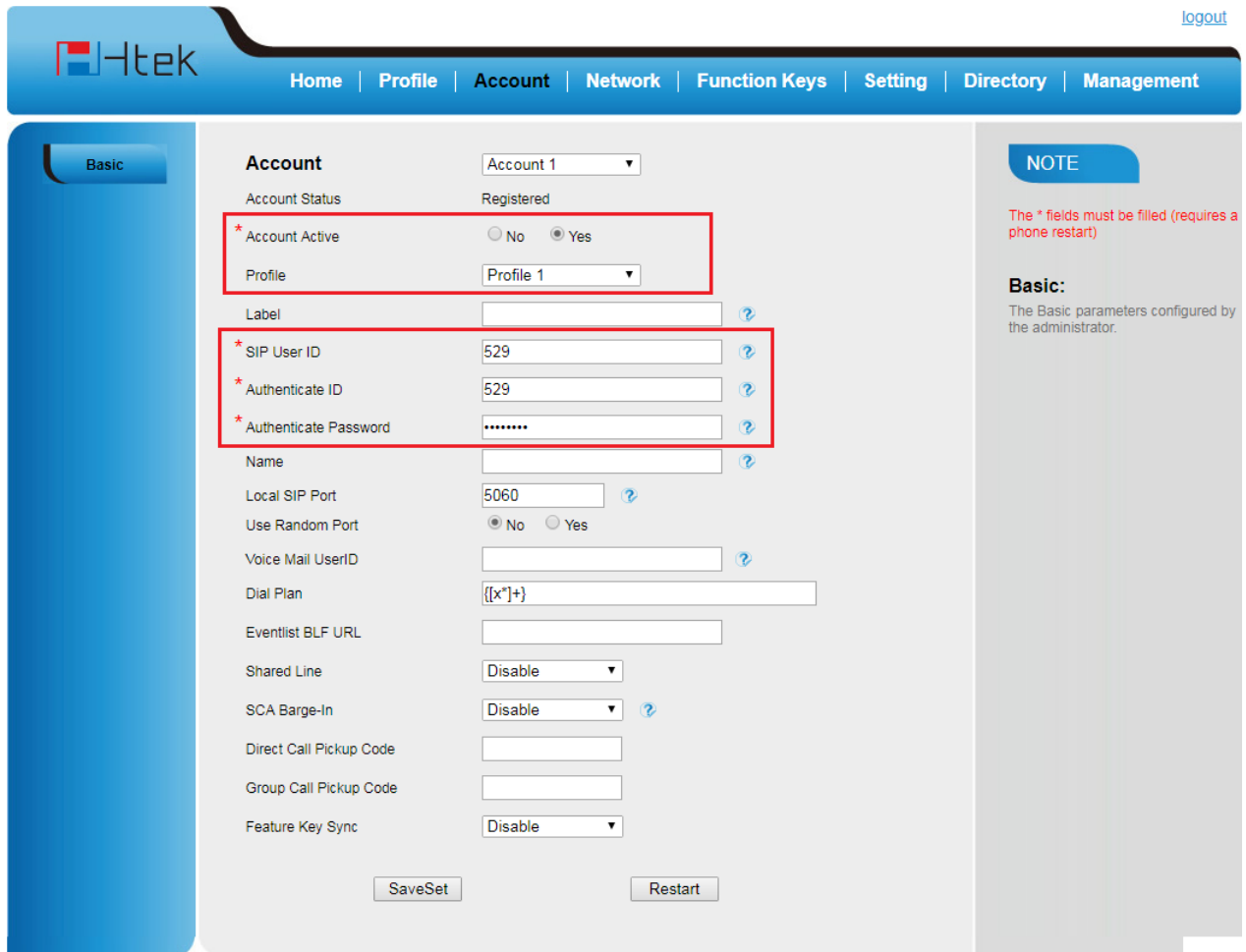

Account Account 1

Account Status Registered

* Account Active No Yes

Profile Profile 1

Label

* SIP User ID 529

* Authenticate ID 529

* Authenticate Password

Name

Local SIP Port 5060

Use Random Port No Yes

Voice Mail UserID

Dial Plan {[x*]+}

Eventlist BLF URL



Shared Line Disable

SCA Barge-In Disable

Direct Call Pickup Code

Group Call Pickup Code

Feature Key Sync Disable

NOTE

The * fields must be filled (requires a phone restart)

Basic:
The Basic parameters configured by the administrator.

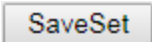

6. Select Yes for Account Active.
7. Select the desired Profile.
8. Fill the SIP User ID, Authenticate ID, Authenticate Password and other account information.
9. Click  to save the configuration.

Note:

1. All fields with * must be filled. If changed, it requires a phone restart.
2. Account Status says the account registered successfully or not.
3. When change the account information via phone, it will shown Restart note when back to idle page.

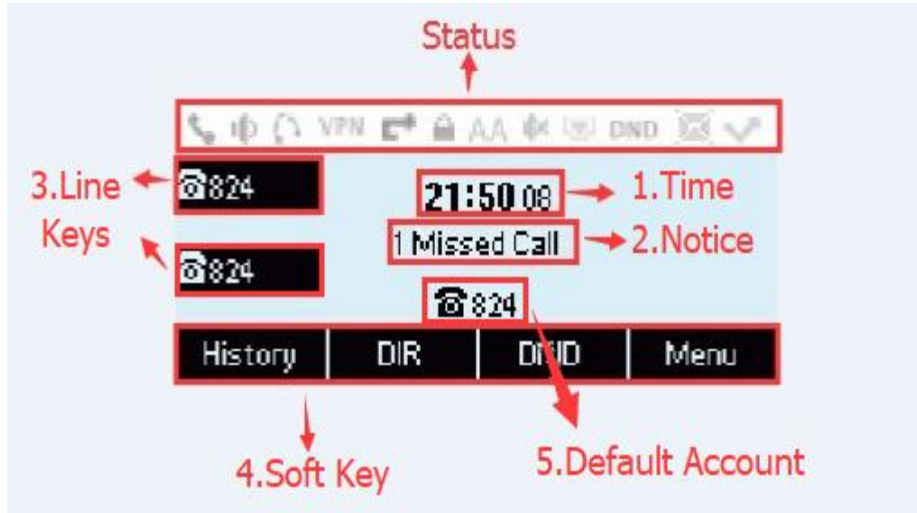
Idle Screen







Name	Description
1. Date & Time	It shows the phone's time & date. For Date& time setting, see Time&Date
2. Notice	It shows the phone features status, More see Icon Preview
3. Line Keys	This area shows the four line key labels. Line keys are also can be used as other function keys. For more information you can refer to Line Keys
4. Soft Key	This area shows the soft key labels. The default soft key labels are "History", "Directory", "DND" and "Menu". More to see Programmable Key
5. Default Account	This shows the current use account. User can   use to change the default use account.

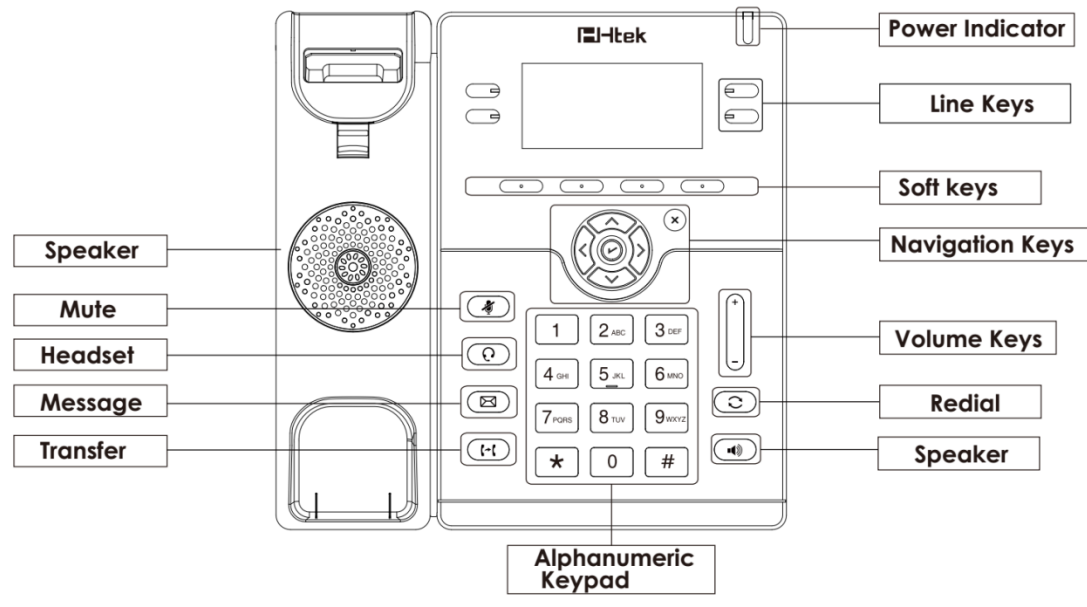





Getting Familiar with Your Phone

Hardware Components Preview













Item	Description
LCD screen	To Presentation all information about the date& time, accounts, soft keys, messages, calls and other some information.
Power Indicator LED	To indicate the power status
Line keys	The phone supported up to 2 accounts 1. Steady green: idle interface, during a call.. 2. Blink red: a call incoming
Soft keys	Labels automatically to identity their context-sensitive features.
Navigation keys	<ul style="list-style-type: none">  1. OK.  Up arrow key: To move up of the selection shown on the screen.  Right arrow key: To move right of the selection shown on the screen.  Left arrow key: To move left of the selection shown on the screen.  Down arrow key: To move down of the selection shown on the screen.

	 <ol style="list-style-type: none"> 1. To return to idle screen. 2. To cancel the information or call on the screen.
<p>Mute key</p>	 <ol style="list-style-type: none"> 1. To mute the voice during the call (green light). 2. To un-mute the call.
<p>Line Keys</p>	<p>To be configured as different function as:</p> <ol style="list-style-type: none"> 1. Line 2. Speed Dial 3. BLF 4. BLF List 5. Voice Mail 6. Direct Pickup 7. Group Pickup 8. Call Park 9. Intercom 10. DTMF 11. Prefix 12. Local Group 13. XML Group 14. XML Browser 15. LDAP 16. Network Directories 17. Conference 18. Forward 19. Transfer 20. Hold 21. DND 22. Redial 23. Call Return 24. SMS 25. Record 26. URL Record 27. Paging 28. Group Listening 29. Public Hold 30. Private Hold 31. Hot Desking 32. ACD 33. Zero Touch 34. URL 35. Network Group 36. Multicast Paging 37. Group Call Park 38. CallPark Retrieve

	<p>39. Pull Call</p> <p>40. Shared Line The LED lights status when set as Shared line: Stay green: Idle Stay red: Busy Blinked green: Ring Back Blinked red: A call incoming Steady orange: During a call Blinked orange: Public Hold Blinked green: Private Hold Light Down: Unregistered</p> <p>41. Broadsoft Group</p>
Speaker	 Press this button to place a call in hands-free mode.
Redial	 <p>To dial the previous dialed number. To act as send key.</p>
Volume	<p> To decrease the volume.</p> <p> To increase the volume.</p>
Alphanumeric keypad	To enter the phone numbers, letters and so on.
Headset	 To indicate that the phone is or not in Headset mode.
Transfer	 <p>To transfer a call to a third party. To enable or disable Forward feature during the idle page.</p>
Message	 To indicator the New message, and press to read.

Icon Preview

Icon	Description
	Network

	Registered succeed
	Unregistered
	Speakerphone mode
	Handset mode
	Headset mode
	Mute
	Forward
	Do Not Disturb
	SRTP
	Received calls
	Dialed Calls
	Missed calls
	Forward calls

LED Instruction

This part mainly instructs the LED status. The Power LED Status describe on the premise that the LED setting all set as Yes. For LED status setting, please refer to: [LED Status Setting](#)

Power Indicator LED

LED Status	Description
Blinked green	Ringling or have missed call
Steady Green	Idle status(Power on)
Off	Powered off.

Line LED:(Line Key set as Line)

LED Status	Description
Steady Green	Hold
Steady Green	Off hook or during a conversation.
Blinked red	Ringling.
Off	Idle status

BLF or BLF List Key LED :(Line Key set as BLF)

LED Status	Description
Steady Green	Idle status for the monitored line
Steady Red	The monitored line is calling or during a call
Blinked red	The monitored line is ringing.
Off	All other unknown status

Shared Line Key LED:

LED Status	Description
off	Idle status

Stay green	a member of the SCA group in off-hook status
Stay red	Other member of the SCA group's led status when a member of the SCA group in off-hook status
Blinked green every 500ms	a member of the SCA group in Private hold status.
Stay red	Other member of the SCA group's led status when a member of the SCA group in Private hold status
Blinked green every 500ms	a member of the SCA group in public hold status
Blinked red every 500ms	Other member of the SCA group's led status when a member of the SCA group in public hold status
Blinked green every 500ms	a member of the SCA group in progressing status
Stay red	Other member of the SCA group's led status when a member of the SCA group in progressing status
Blinked red every 100ms	Alerting
Stay green	a member of the SCA group in active status when there is an incoming call designated for the SCA group
Stay red	Other member of the SCA group's led status when a member of the SCA group in active status

Other Key Led

Key	Description
Headset Key	When use in headset mode, the led is steady green or the LED is off.
Message Key	Blinked green when there is new messages or the LED is off.
Mute Key	Red when the mute the call, or the LED is off.

User Interface

There are two ways to customize specific configurations on your IP phone:

- The user interface on the IP phone
- The user interface in a web browser on your PC

The hardware components keypad and LCD screen constitute the phone user interface, which allows the user to execute all call operation tasks and basic configuration changes directly on the phone. In addition, you can use the web user interface to access all configuration settings. In many instances, it is possible to use both the phone user interface and the web user interface to operate the phone and change settings. However, in some instances, it is only possible to use the phone or the web user interface.

Phone Interface Overview

Option	
Status	Information
	Network
	Accounts
Features	Call Forward
	Function Keys (Line and Line Key setting) More Key see Line Key Overview
	Key as Send
	Hot Line
	Anonymous Call
	DND
	History Setting
DIR	All Contacts
	Contacts
	BlackList
History	Local History
	Network CallLog
Message	Voice Mail View and Set.
	Text Message View and Set.
Basic Setting	Language
	Time & Date
	Time & Date Format
	DHCP Time
	Ring Tone

	Headset
	Screensaver
	User Mode
	Gray Level
	Font Size
Advanced Setting	Accounts
	Network
	Phone Setting
	Auto Provision
Others	Factory Function
	System Restart
	Device Reboot
	Pcap Feature

Line Key Function Overview

Line
Speed Dial
BLF
BLF List
Voice Mail
Direct Pickup
Group Pickup
Call Park
Intercom
DTMF
Prefix

Local Group
XML Group
XML Browser
LDAP
Network Directories
Conference
Forward
Transfer
Hold
DND
Redial
Call Return
SMS
Record
URL Record
Paging
Group Listening
Public Hold
Private Hold

Hot Desking
ACD
Zero Touch
URL
Network Group
Multicast Paging
Group Call Park
CallPark Retrieve
Pull Call
Shared Line
Broadsoft Group

Basic Features Configuration

This part will mainly introduce the basic configuration as the Time, Language, and Volume...

General Settings

Web Login

1. Get the IP address: Press Menu →Status→ Information

```

1.Model:UC912G
2.IPV4:192.168.1.224
3.IPV6:2015:1fc1:1111:1111:f42c:2897:77..
Back
    
```

2. Input the IP Address in the web browser.
3. Input the user name (default is admin), password (default is admin).
4. Login successfully.

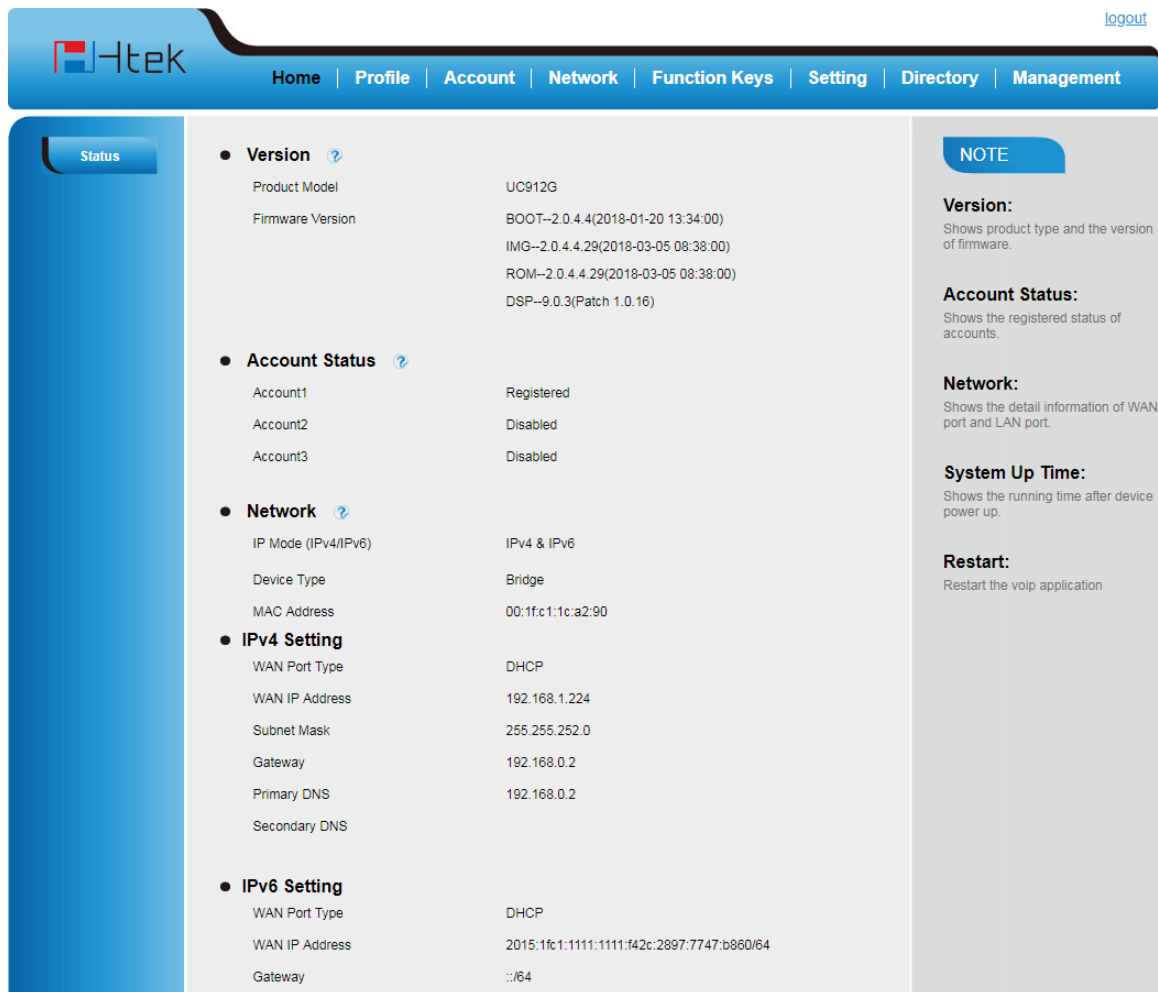

The screenshot shows the Htek web management interface. At the top, there is a navigation bar with the Htek logo and a 'logout' link. Below the navigation bar, there are menu items: Home, Profile, Account, Network, Function Keys, Setting, Directory, and Management. The main content area is titled 'Status' and contains several sections:

- Version:** A table showing Product Model (UC912G) and Firmware Version (BOOT--2.0.4.4(2018-01-20 13:34:00), IMG--2.0.4.4.29(2018-03-05 08:38:00), ROM--2.0.4.4.29(2018-03-05 08:38:00), DSP--9.0.3(Patch 1.0.16)).
- Account Status:** A table showing Account1 (Registered), Account2 (Disabled), and Account3 (Disabled).
- Network:** A table showing IP Mode (IPv4/IPv6) (IPv4 & IPv6), Device Type (Bridge), MAC Address (00:1f:c1:1c:a2:90).
- IPv4 Setting:** A table showing WAN Port Type (DHCP), WAN IP Address (192.168.1.224), Subnet Mask (255.255.252.0), Gateway (192.168.0.2), Primary DNS (192.168.0.2), and Secondary DNS.
- IPv6 Setting:** A table showing WAN Port Type (DHCP), WAN IP Address (2015:1fc1:1111:1111:f42c:2897:7747:b860/64), and Gateway (::/64).

On the right side, there is a 'NOTE' section with the following information:

- Version:** Shows product type and the version of firmware.
- Account Status:** Shows the registered status of accounts.
- Network:** Shows the detail information of WAN port and LAN port.
- System Up Time:** Shows the running time after device power up.
- Restart:** Restart the voip application.

Note:

The PC and phone should be in the same segment.

When register the accounts in web and the server port is not “5060”, then “SIP Server” should be set as “SIP Server’s IP address: server port.”, for example, “192.168.0.122: 5090”.

Administrator Password

The password is mainly used for login the web interface or set the advanced settings through phone interface. And the default password of the administrator is: **admin**

To change to password via Phone interface

1. Press Menu → Settings → Advanced Setting → password (default admin) → Phone Setting → Set Password
2. Enter the current PWD (password), new password and confirm the new password.
3. Press Save soft key or  to save the new password.

1.Current PWD: |
 2.New PWD:
 3.Confirm:
 Cancel 2aB Delete Save

To change to password via Web interface

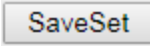
1. Management → Password
2. Fill the value
3. Click  to save the configuration.

Note:

When you use the web interface: user name: admin password: admin(default)

Language

The default Phone interface language is English.

To change the language via Phone interface

1. Press Menu → Settings → Basic Setting → Language.
2. Press  or Save soft key to save the configuration.

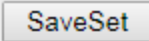

To change the language via Web interface

1. Setting → Preference → Web Language & LCD Language.
2. Select the necessary one.
3. Press  to save the configuration.

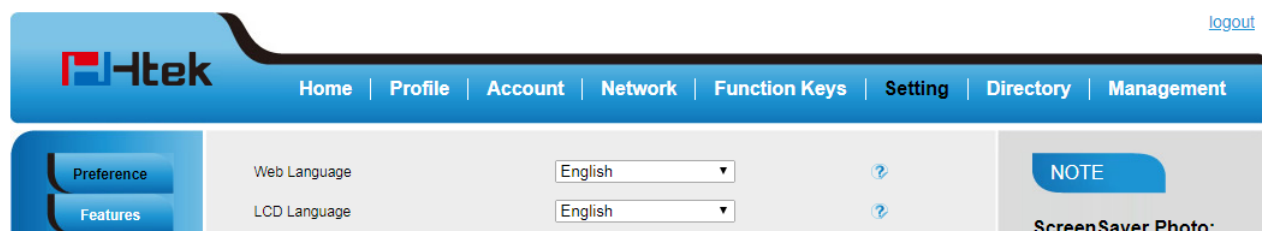



Note:

All languages may not be available for selection. The available languages depend on the language packs currently loaded to the IP phone.

Screen Saver

There are two types of screen saver: Backlight off, Time & Logo .



To enable screen saver via Phone interface

1. Press Menu → Settings → Basic Setting → Screensaver...
2. Press  and  or press Switch soft key to Choose the Time-out as 1 min or

2/5/10/30 minute, then press the Save button.

3. Enter the Screensaver Type to choose one of the type: Logo only, Time & Logo.
4. Press  or Save soft key to save the selected configuration.

To disable screen saver via Phone interface

1. Press Menu → Settings → Basic Setting → Screensaver...
2. Press  and  or press Info/Switch soft key to Choose the Time-out as off.
3. Press  or Save soft key to save the selected configuration.

To Enable screen saver via Web interface

1. To Click Setting → Preference
2. To choose the Time-out as 1 min or 2/5/10/30 minute.
3. To select the screen Type as Logo only or time & logo.
4. Click SaveSet to save the configuration.

Screen Time Out	1 min	?
Text Logo		?
ScreenSaver Type	time & logo	

To Disable screen saver via Web interface

1. To Click Setting → Preference
2. To choose the Time-out as Off
3. Click SaveSet to save the configuration.

Screen Time Out	off	?
Text Logo		?
ScreenSaver Type	time & logo	

To custom text logo via Web interface:

1. Click Setting → Preference.

2. Choose the Time-out as 1 min or 2/5/10/30 minute.
3. Enter the desired value in the Text Logo field.
4. Click SaveSet to save the configuration.

Screen Time Out	1 min	<div style="border: 2px solid red; padding: 5px; color: red; font-size: small;"> it will work when screensaver type is time & logo or logo only, and '\n' represents the newline </div>
Text Logo	Welcome	

To wake up screen saver via Web interface:

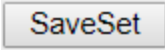

1. Click Setting → Preference
2. Choose Dial First Digit: Screensaver Wakes up or Screensaver Wakes up and Dial
3. Click  to save the configuration.

Dial First Digit	<input checked="" type="radio"/> Screensaver Wakes up <input type="radio"/> Screensaver Wakes up and Dial
------------------	--

Gray Level

There are 20 levels. you can change the LCD's brightness according to your visual perception



To change the gray level via Phone interface

1. Press Menu → Settings → Basic Setting → Gray level
2. Press  and  or press Info/Switch soft key to Choose the level from 1 to 20
3. Press  or Save soft key to save the selected configuration

Time and Date

The time and date show on the idle page, and it can be set and change by SNTP server automatically or manual setting.



To configure the time and Date by SNTP setting

1. Press Menu → Settings → Basic Setting → Time & Date → SNTP Settings
2. Press  or , or Info/Switch soft key to change the Time zone.
3. Fill the NTP server1, NTP Server2, and Daylight Saving.





4. Press  or Save soft key to save the configuration.





To configure time and date manually via Phone interface

1. Press Menu → Settings → Basic Setting → Time & Date → Manual
2. Press  and  or change the right time, or you can input the right time.
3. Press  or Save soft key to save the configuration.

To configure the Time & Date Format

1. Press Menu → Settings → Basic Setting → Time & Date Format
2. Press  and  or press Info/Switch to change between 12 Hour or 24 Hour.
3. Press  and  or press Info/Switch to change among Y-M-D(year-month-day), M-D-Y(month-day-year), D-M-Y(day-month-year).
4. Press  or Save soft key to save the configuration.

To configure the DHCP time

1. Press Menu → Settings → Basic Setting → DHCP time
2. Press  and  or press Info/Switch to change between Disable and Enable.
3. Press  or Save soft key to save the configuration.

To configure the NTP Server by web interface

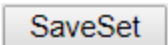
1. Login
Login name: admin, password: admin (default)
2. Setting → Date & Time → NTP Server
3. Fill the value in the blank.
4. Click  to save the configuration.

Preference
Features
BLF Settings
Date&Time
Tones
SMS
Action URL
Softkey Layout
TR069
SIP

Home | Profile | Account | Network | Function Keys | **Setting** | Directory | Management

logout

DHCP Option 100 No Yes ?

DHCP Time No Yes ?

Time Zone ?

NTP Server is Covered with DHCP No Yes ?

NTP Server ?

Backup NTP Server ?

SIP Date Override Time No Yes ?

Account ?

Daylight Saving Time Disable Enable Auto ?

Time Format 24 Hour 12 Hour ?

Date Display Format Year - Month - Day ?
 Month - Day - Year ?
 Day - Month - Year ?

NOTE

Time Zone:
Select the time zone of your location.

NTP Server
The server which is used to synchronize the clock of the phone.

To change the Time Zone and Date Display Format via Web interface

1. Setting → Date & Time
2. Select the necessary one.
3. Press to save the configuration.

Preference
Features
BLF Settings
Date&Time
Tones
SMS
Action URL
Softkey Layout
TR069
SIP

Home | Profile | Account | Network | Function Keys | **Setting** | Directory | Management

logout

DHCP Option 100 No Yes ?

DHCP Time No Yes ?

Time Zone ?

NTP Server is Covered with DHCP No Yes ?

NTP Server ?

Backup NTP Server ?

SIP Date Override Time No Yes ?

Account ?

Daylight Saving Time Disable Enable Auto ?

Time Format 24 Hour 12 Hour ?

Date Display Format Year - Month - Day ?
 Month - Day - Year ?
 Day - Month - Year ?

NOTE

Time Zone:
Select the time zone of your location.

NTP Server
The server which is used to synchronize the clock of the phone.

To change the SIP Date Override Time via Web interface

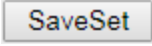
1. Setting → Date & Time → SIP Date Override Time
2. Select Yes or No for SIP Date Override Time .
3. Click  to save the configuration.

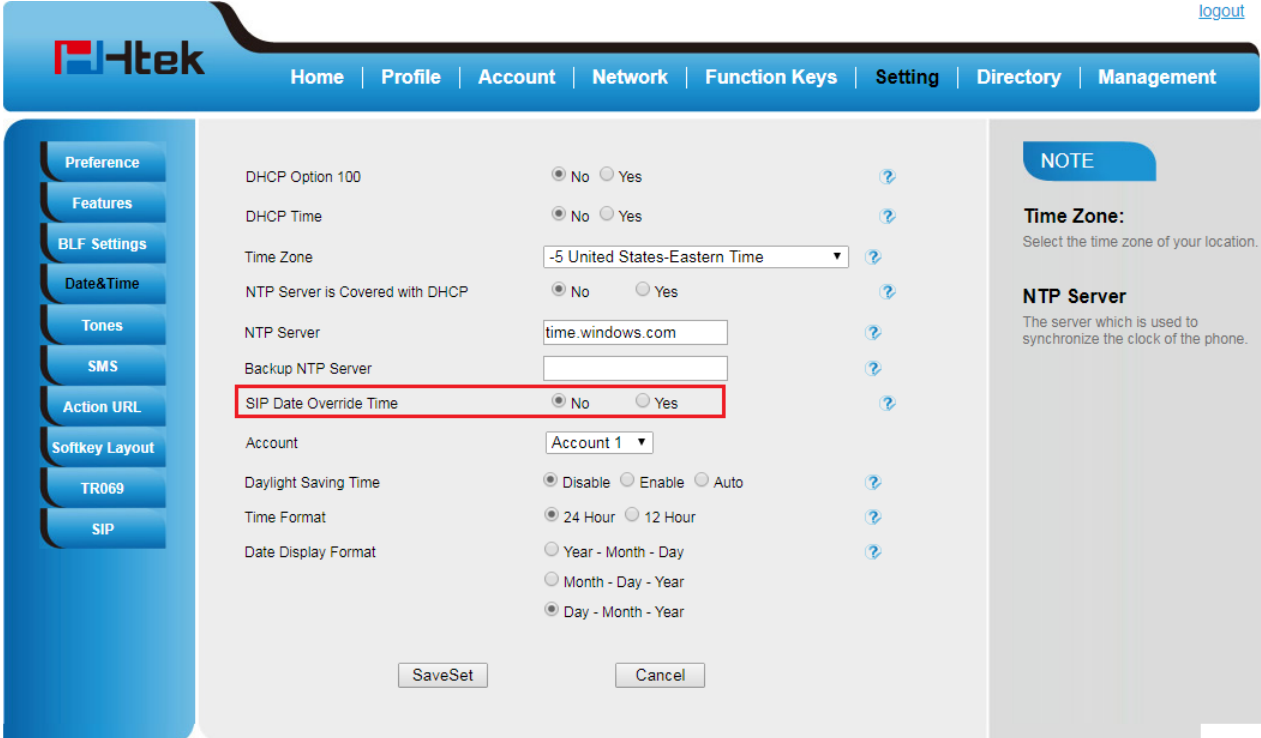

The screenshot shows the Htek web interface for configuring SIP settings. The top navigation bar includes Home, Profile, Account, Network, Function Keys, Setting, Directory, and Management. The left sidebar lists various settings categories: Preference, Features, BLF Settings, Date & Time, Tones, SMS, Action URL, Softkey Layout, TR069, and SIP. The main content area displays the 'Date & Time' settings for 'Account 1'. The 'SIP Date Override Time' option is selected with the 'No' radio button and is highlighted with a red box. Other settings include DHCP Option 100, DHCP Time, Time Zone (-5 United States-Eastern Time), NTP Server (time.windows.com), Backup NTP Server, Daylight Saving Time (Disable), Time Format (24 Hour), and Date Display Format (Day - Month - Year). A 'SaveSet' button is visible at the bottom of the settings area. On the right, there are two notes: 'Time Zone: Select the time zone of your location.' and 'NTP Server: The server which is used to synchronize the clock of the phone.'

To change the Account via Web interface

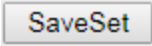
1. Setting → Date & Time → Account.
2. Select desired Account.
3. Click  to save the configuration.

The screenshot shows the 'Date & Time' configuration page. The 'Daylight Saving Time' dropdown menu is open, showing options: Account 1, Account 2, and Account 3. The 'Account 1' option is highlighted. The 'SaveSet' button is visible at the bottom.

To change the Daylight Saving Time via Web interface

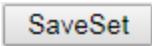
1. Setting → Date & Time → Daylight Saving Time
2. Select Disable or Enable or Auto for Daylight Saving Time.
3. Click  to save the configuration.

The screenshot shows the 'Date & Time' configuration page. The 'Daylight Saving Time' radio buttons are selected, showing options: Disable, Enable, and Auto. The 'SaveSet' button is visible at the bottom.

Note:

If the IP Phone cannot obtain the time and date from the Simple Network Time Protocol (SNTP) server, please contact your system administrator for more information.

Daylight Saving Time

Daylight Saving Time (DST) is the practice of temporary advancing clocks during the summertime so that evenings have more daylight and mornings have less. Typically, clocks are adjusted forward one hour at the start of spring and backward in autumn. Many countries have used the DST at various times, details vary by location. The DST can be adjusted automatically from the time zone configuration. Typically, there is no need to change this setting.

LED Status Setting

The LED Status setting mainly defines the power indicator LED.

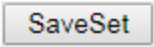

To configure LED Status via Web interface :

1. Click Setting → Preference
2. Select Yes or No for Power Status, Ringing Status, Miss Calls Status and Voice Message Status.
3. Click  for the setting.

For the LED status description, see: LED Instruction [Power Indicator LED](#)



LED Status Setting:		
Power Status	<input checked="" type="radio"/> Yes	<input type="radio"/> No
Ringing Status	<input checked="" type="radio"/> Yes	<input type="radio"/> No
MissCalls Status	<input type="radio"/> Yes	<input checked="" type="radio"/> No
Voice Message Status	<input type="radio"/> Yes	<input checked="" type="radio"/> No

Key as Send**To configure Key as Send**

1. Press Menu → Features → Key as Send
2. Press  and  or press Info/Switch soft key to select the enable choice.

3. Press  or Save soft key to save the configuration

To cancel # Key as Send

1. Press Menu → Features → Key as Send
2. Press  and  or press Info/Switch soft key to select the disable choice.
3. Press  or Save soft key to save the configuration.

Network Setting

Htek IP Phone supports IPv4、IPv6、IPv4&IPv6.They have three mode of Network: DHCP, Static, and PPPoE. The default mode is DHCP, it will obtain IP address and other information automatically.

If your phone cannot contact a DHCP server for any reason, you need to configure a static IP address manually.

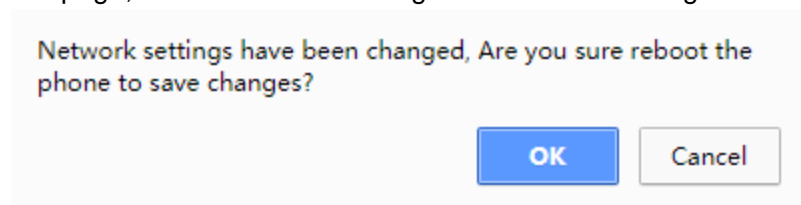

When switch DHCP, Static IP and PPPoE to each other, or change the Static IP on webpage, it will show the warning of restart as following.



IPv4

If you set IP Mode to IPv4,IP phone will use IPv4 address. IPv4 has three network modes: DHCP, Static, and PPPoE

To configure IPv4 via Phone interface:

1. Press Menu→ Settings→ Advanced Setting (password: admin) → Network→ WAN Port → IP Port Mode.
2. Press  or  to change the IP Port Mode..
3. Press  or Save soft key to save the configuration.

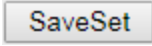

To configure IPv4 via Web interface:

1. Click Network→ Basic→ Internet Port
2. Select IPv4 for Internet Port
3. Click  for the setting.

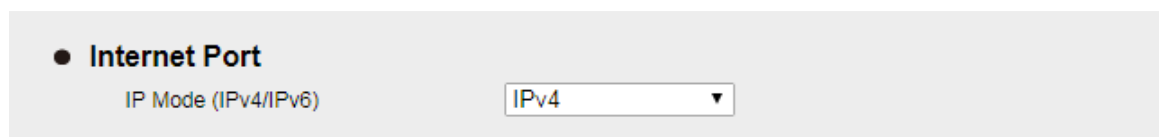

To configure DHCP via Phone interface:

1. Press Menu→ Settings→ Advanced Setting (password: admin) → Network→ WAN Port→ IPv4→ DHCP mode.
2. Click Save and restart the phone.

To configure a static IP address via Phone interface:

1. Press Menu→ Settings→ Advanced Setting (password: admin) → Network→ WAN Port → IPv4 → Static mode.
2. Enter the parameters: IP, Netmask, Gateway, Pri.DNS(primary DNS), Sec.DNS (secondary DNS) in the corresponding fields.

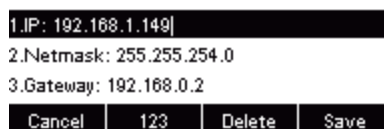

3. Click Save and restart the phone.

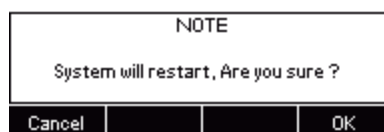

4. Press the Save soft key to accept the change or the Cancel soft key to cancel. If you are using an xDSL modem, you can connect your phone to the Internet via PPPoE mode. You can set a WAN port to be a PPPoE port. The PPPoE port will perform a PPP negotiation to obtain the IP address. Contact your system administrator for the PPPoE user name and password.

To configure PPPoE via Phone interface:

1. Press Menu→ Settings→ Advanced Setting (password: admin) → Network→ WAN

Port → PPPoE mode.

2. Enter the User ID and password
3. Click Save and restart the phone.

1. User ID: 02584685230
 2. Password: xxxxxxxx

Cancel 2aB Delete Save

To configure Network via Web interface :



1. Click Network→ Basic→ IPv4 setting
2. Select the desired Type: DHCP, Static or PPPoE
3. Filled the necessary information.
4. Click the SaveSet and restart the phone.

IPv6

If you set IP Mode to IPv6, IP phone will use IPv6 address. IPv4 has two network modes:

DHCP, Static

To configure IPv6 via Phone interface :

1. Press Menu→ Settings→ Advanced Setting (password: admin) → Network→ WAN Port → IP Port Mode.
2. Press  or  to change the IP Port Mode..
3. Press  or Save soft key to save the configuration.

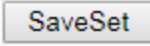

To configure IPv6 via Web interface :

1. Click Network→ Basic→ Internet Port
2. Select IPv6 for Internet Port
3. Click  for the setting.

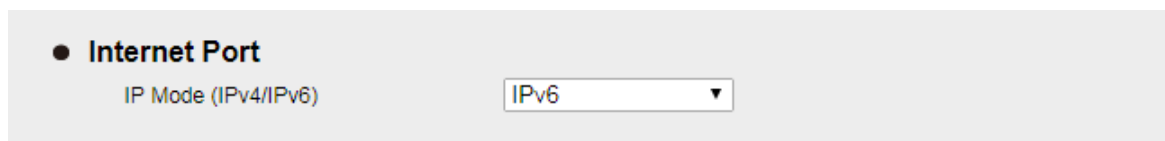

To configure DHCP via Phone interface :

1. Press Menu→ Settings→ Advanced Setting (password: admin) → Network→ WAN Port→ IPv6→ DHCP mode.
2. Click Save and restart the phone.

To configure a static IP address via Phone interface :

1. Press Menu→ Settings→ Advanced Setting (password: admin) → Network→ WAN Port → IPv6 → Static mode.
2. Enter the parameters: IP, IPV6 Prefix, Gateway, Pri.DNS(primary DNS), Sec.DNS (secondary DNS) in the corresponding fields.



3. Click Save and restart the phone.

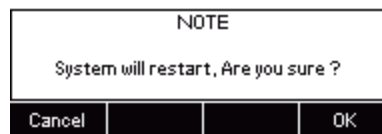

To configure Network via Web interface :

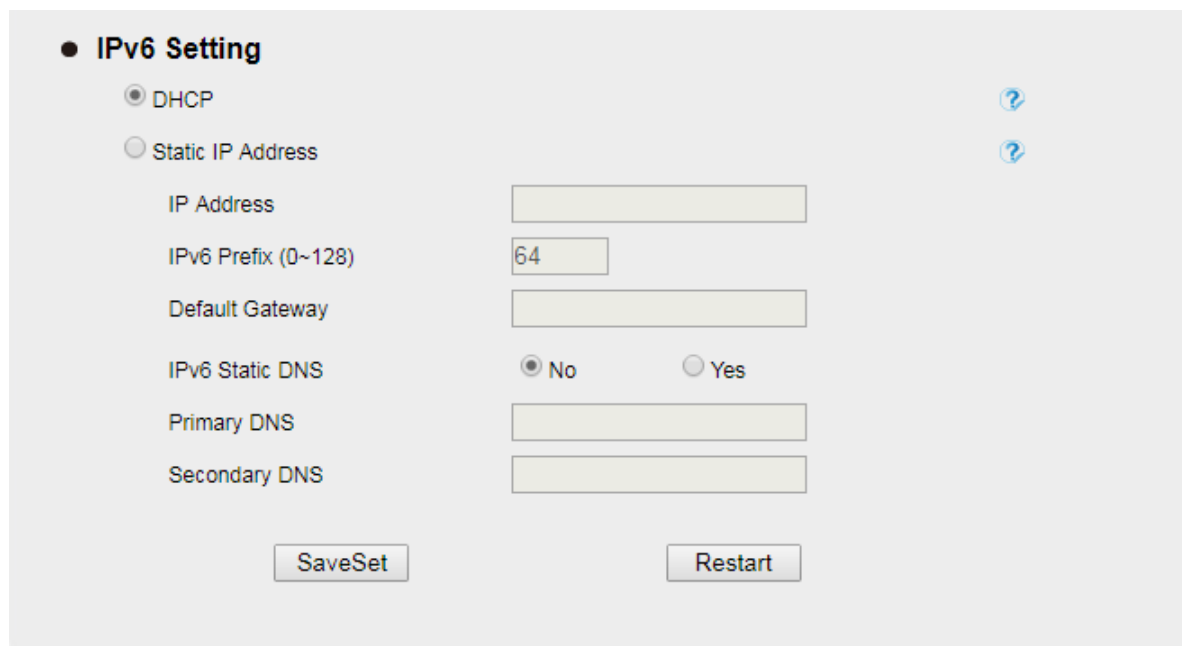

1. Click Network→ Basic→ IPv6 setting
2. Select the desired Type: DHCP, Static
3. Fill required fields.
4. Click the SaveSet and restart the phone.



IPv4&IPv6

If you set IP Mode to IPv4&IPv6, IP phone will support both IPv4 and IPv6 address. The settings of DHCP, Static, and PPPoE are same as above.

To configure IPv4&IPv6 via Phone interface :

1. Press Menu→ Settings→ Advanced Setting (password: admin) → Network→ WAN Port → IP Port Mode.
2. Press  or  to change the IP Port Mode..

- Press  or Save soft key to save the configuration.

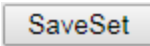

To configure IPv4&IPv6 via Web interface:

- Click Network→ Basic→ Internet Port
- Select IPv4&IPv6 for Internet Port
- Click  for the setting.

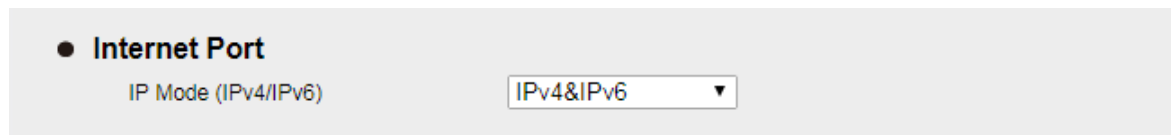

Note:

Wrong network parameters may result in inaccessibility of your phone and may also have an impact on your network performance. For more information about these parameters, contact your system administrator.

PC Port

Two modes for PC port: bridge and router.

To configure PC Bridge via Phone interface :

- Press Menu→ Settings→ Advanced Setting (password: admin) → Network→ PC Port → Bridge mode.
- Click Save and restart the phone.

To configure PC router via Phone interface :

- Press Menu→ Settings→ Advanced Setting (password: admin) → Network→ PC Port → Router mode.
- Enter the IP, Netmask and DHCP server

3. Click Save and restart the phone.

To configure Bridge via Web interface:

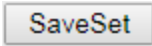
1. Click Network→ PC Port
2. Select As Bridge.
3. Click  and restart the phone

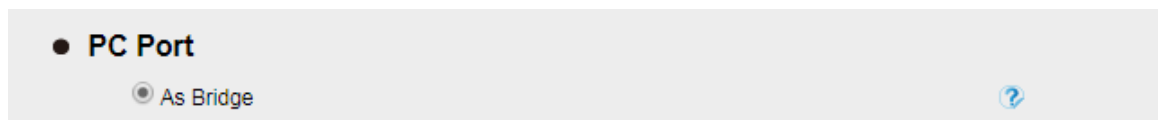

To configure Router via Web interface:

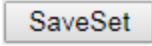
1. Click Network→ PC Port
2. Select As Router
3. Fill the IP address and other necessary information.
4. Click  and restart the phone

● **PC Port**

As Bridge ?
 As Router ?

IP Address
 Subnet Mask
 IP Lease Time
 DHCP Server ▼
 DMZ IP

Port Map

Wan port 0	Lan IP	Lan port 0	Protocol	UDP
Wan port 0	Lan IP	Lan port 0	Protocol	UDP
Wan port 0	Lan IP	Lan port 0	Protocol	UDP
Wan port 0	Lan IP	Lan port 0	Protocol	UDP
Wan port 0	Lan IP	Lan port 0	Protocol	UDP
Wan port 0	Lan IP	Lan port 0	Protocol	UDP
Wan port 0	Lan IP	Lan port 0	Protocol	UDP
Wan port 0	Lan IP	Lan port 0	Protocol	UDP

Contact Settings

This section provides the operating instructions for managing contacts. The topics include:

- Local Directory
- Remote Phonebook
- LDAP
- Search Contact

Local Directory

In the directory, you can add or delete your friends, business partner or anyone others' phone No. so you will not forget their number. Or put some anonymous phone No. in the blacklist to prevent from being disturbed. The local Directory can add up to 1000 contacts.

A. To add contacts list into local directory





To add contacts manually

1. Press Menu → DIR→ Contacts...
2. Press Add soft key

1.Name: |
2.Number:
3.Mobile Number:
Cancel 2aB Delete Save

3. Enter the necessary information as Name, Phone number...
4. Press Save soft key or  to add the contacts successfully.

To add contacts from History via Phone interface

1. Press History soft key or press Menu →History→ Local History
2. Press  and  to select the targeted one. (Press  and  switched among the All calls, Dialed calls, Received calls, Missed Calls and Forward Calls).
3. Press Option soft key → Add to Contacts
4. Edit the necessary information as Name, Phone number...
5. Press Save soft key or  to add the contacts successfully.

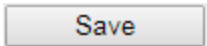

To add contacts via Web interface

1. Click Directory→ Directory
2. Enter the name, number and some other information.
3. Press  and then press  button.

The screenshot shows the Htek web interface for configuring the BlackList. The top navigation bar includes Home, Profile, Account, Network, Function Keys, Setting, Directory, and Management. The left sidebar contains Directory, Remote Phone Book, Call History, LDAP, Network Directory, and MultiCast Paging. The main content area is titled 'Contact BlackList' and features a table with columns for Index, Display Name, Office Number, Mobile Number, Other Number, and Account. Below the table are buttons for Save, Delete, and Move to Contact/blacklist. A form for adding a contact is visible, with fields for Name (Luisa), Office Number (860), Mobile Number, Other Number, Account (Auto), Ring (Default), Group (Not In Group), and Photo (Auto). The 'Add' button is highlighted with a red box. To the right, there is a 'NOTE' section with instructions for adding, deleting, moving, and exporting contacts.



B: To add contacts into blacklist

To add blacklist manually via Phone interface

1. Press Menu → DIR → BlackList
2. Press Group soft key.
3. Press Add soft key.
4. Enter the Name and select the Ring Tone.
5. Press Save soft key or  to add the Group successfully.
6. Enter the added Group, then press Add soft key.
7. Enter the necessary information as Name, Phone number...
8. Press Save soft key or  to add the contacts successfully.

To add blacklist from history via Phone interface

1. Press History soft key or press Menu → History → Local History

2. Press  and  to select the targeted one.
3. Press Option soft key → Add to Blacklist
4. Edit the necessary information as Name, Phone number...
5. Press Save soft key or  to add successfully.

To import or export the contact list

You can manage your phone's local directory via phone or web user interface. But you can only import or export the contact list via Web interface.

To import an XML file of contact list via Web interface:

1. Click on Directory → Directory
2. Click Choose file to select a contact list file (file format must be .xml) from your local system.
3. Click Import XML to import the contact list.

To export an XML file of contact list via Web interface:

1. Click on Directory → Directory
2. Click Export XML to export the contact list.

To import a CSV file of contact list via Web interface:

1. Click on Directory → Directory
2. Click Choose file to select a contact list file (file format must be .csv) from your local system.
3. Click Import Csv to import the contact list.

To export a CSV file of contact list via Web interface:

1. Click on Directory → Directory
2. Click Export Csv to export the contact list.

<p>Contact</p> <p>Name <input type="text"/></p> <p>Office Number <input type="text"/></p> <p>Mobile Number <input type="text"/></p> <p>Other Number <input type="text"/></p> <p>Account <input type="text" value="Auto"/></p>	<p>Import Local Contacts</p> <p><input type="button" value="Choose file"/> <input type="button" value="No file chosen"/></p> <p><input type="button" value="Import XML"/> <input type="button" value="Export XML"/></p> <p><input type="button" value="Choose file"/> <input type="button" value="No file chosen"/></p> <p><input type="button" value="Import Csv"/> <input type="button" value="Export Csv"/> <input checked="" type="checkbox"/> Show Title</p>
--	---

Note:

If the xml file and CSV file more than 1000 contacts, the phone will only upload 1000 contacts.

Remote Phonebook

To set Remote Phonebook via Web interface :

1. Login the webpage and click Directory→ Remote Phone Book
2. Fill the path of the remote file in the Phone Book URL field.
For example,
http://192.168.0.106/Phonebook/Remote_Phonebook/remotephonebook.xml
3. Fill the Name and then click to save the configuration.

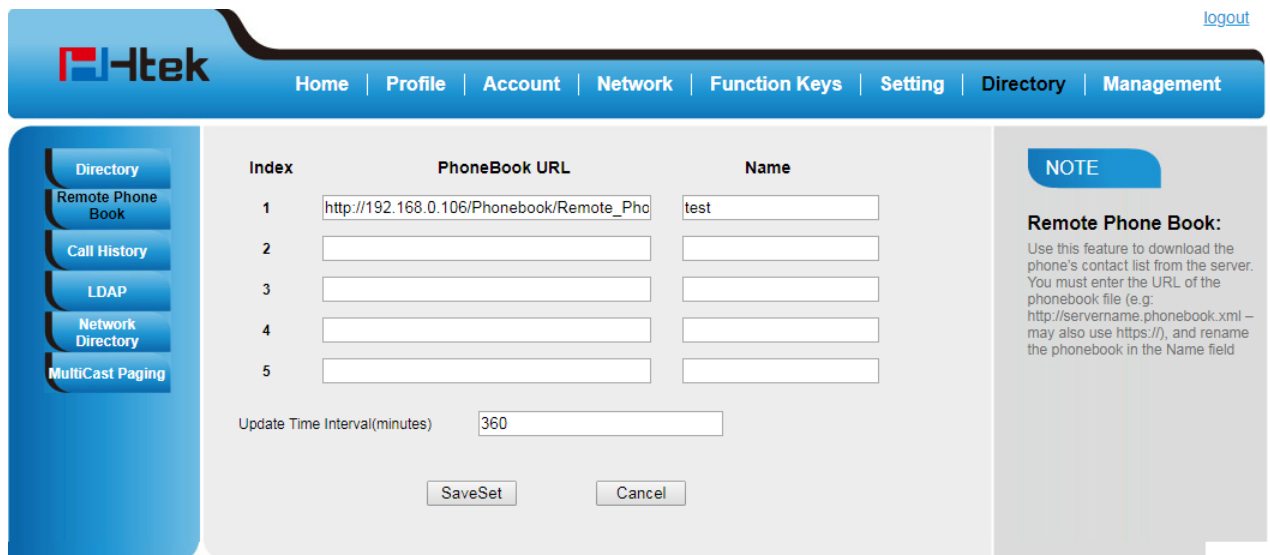

To check the contacts via Phone interface :

Press Directory→ Left Button→ Left Button, and then you can see the item you set, press enter you will find the detail.

For More detail, please refer to: [Remote Phonebook](http://www.htek.com) on www.htek.com .

Note:

Every remote contact only support 1000 contacts.

LDAP Phonebook

When use the LDAP feature, you can get the LDAP Phonebook directly.

To configure LDAP via Web interface :

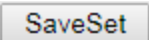
1. Login Web interface and click Directory→ LDAP
2. Fill the LDAP Name Filter:
 - a) This parameter specifies the name attributes for LDAP searching. The “%” symbol in the filter stands for the entering string used as the prefix of the filter condition.
 - b) For example (cn=%), when the name prefix of the cn of the contact record matches the search criteria, the record will be displayed on the IP PHONE LCD.
3. Fill LDAP Number Filter:
This parameter specifies the number attributes for LDAP searching.
4. Fill Server Address: Fill the domain name or IP address of the LDAP Server.
For example: 192.168.0.124
5. Port(the port of the LDAP Serve) Base, User Name, Password
6. Max.Hits(1-32000): the maximum number of the search results to be returned by the LDAP server.
7. LDAP Display Name: the display name of the contact record displayed on the LCD screen.
8. Fill the relative value and then click  to save the settings.

Following is the example screenshot for the configuration.

To Configure LDAP Key

To configure LDAP Key via Web interface :

1. Click Function Keys→ Line Key→ choose Line Key 2(for example)
2. Select LDAP in the Type field.
3. Click to save the configuration.

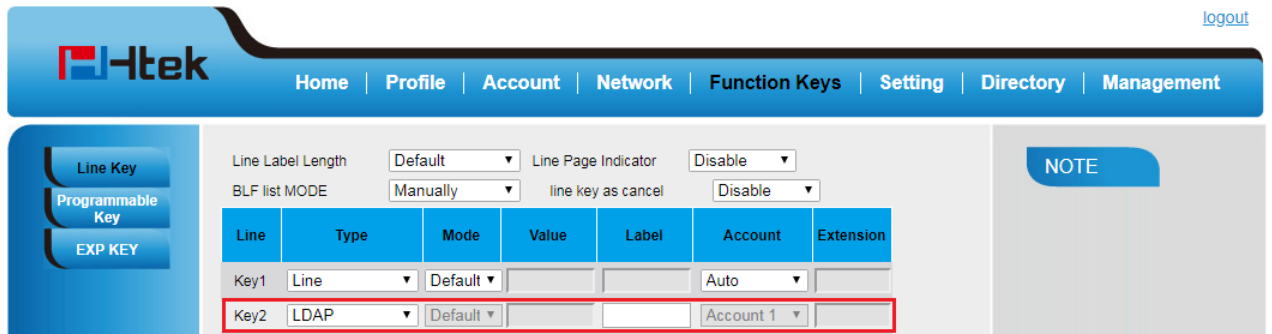

To Configure LDAP Key via Phone interface :

1. Press Menu→ Features→ Function Keys→ Line Keys as Function Keys→ Line Key 2
2. Select LDAP in the Type field
3. Press Save or OK key to save the configuration.

When press the LDAP Key the LCD will display as following:



For More detail, please refer to [LDAP Notes](http://www.htek.com) on www.htek.com

Search Contact

You can search contact in all contacts, local contacts, remote contacts and LDAP contact.

To search contact in all contacts:

1. Click the Directory soft key on Idle interface.
2. Click the More soft key, then you can see the Search soft key
3. Click the Search soft key, you can enter the desired part of name or part of number.
4. With the search content to match the contact will be automatically displayed on the LCD within 5 seconds.

Luisa

Filter: 86			
Back	2aB	Delete	

To search contact in Local contacts:

1. Click the Directory soft key on Idle interface.
2. Click the  button and select the Local contacts list.
3. Click the More soft key, then you can see the Search soft key
4. Click the Search soft key, you can enter the desired part of name or part of number.
5. With the search content to match the contact will be automatically displayed on the LCD within 5 seconds.

To search contact in Remote contacts:

1. Click the Directory soft key on Idle interface.
2. Click the  button and select the remote contacts list.
3. Select the desired the remote contact and click Enter soft key.
4. Click the Search soft key, you can enter the desired part of name or part of number.
5. With the search content to match the contact will be automatically displayed on the LCD within 5 seconds.

To search contact in LDAP contacts:

1. Click the LDAP function key.
2. Enter the first character or more of contact's name.
3. Select the desired the remote contact and click Enter soft key.
4. Then IP Phone will display the relevant contacts automatically within Search Delay.



Call History Settings

Call History

This phone maintains call history lists of Dialed Calls, Received Calls, Missed Calls and Forwarded Calls. The call history list supports up to 100 entries in all on phone interface and more than 1500 items. You can check the call history, dial a call, add a contact or delete an entry from the call history list. You should enable the history record feature in advance.

To enable the history record feature via Phone interface:

1. Press Menu → Features → History Setting

2. Press  and  or Info/Switch soft key to enable History record.
3. Press Save soft key to save the configuration.



To check the call history via Phone interface :

1. Press the History soft key. The LCD screen displays All Calls list.
2. Press Right or Left Key to switch among All Calls, Missed Calls, Received Calls, Dialed Calls and Forwarded Calls.
3. Press to select the desired entry.
4. Press the Option soft key, and then select Detail from the prompt list.
5. The detailed information of the entry appears on the LCD screen.

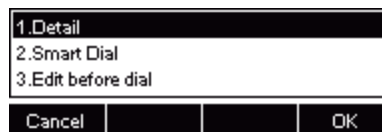

To delete an entry from the call history list via Phone interface :

1. Press the History soft key.
2. Press Right or Left Key to switch among All Calls, Missed Calls, Received Calls, Dialed Calls and Forwarded Calls.
3. Press UP or DOWN key to select the desired entry.
4. Press the Delete soft key.

To delete all entries from the call history list via Phone interface :

1. Press the History soft key.
2. Press Right or Left Key to switch among All Calls, Missed Calls, Received Calls, Dialed Calls and Forwarded Calls.
3. Press the Option soft key, and then select Delete All from the prompt list.

4. Press the OK soft key.
5. Press the OK soft key to confirm the deleting or the Cancel soft key to cancel.

To check the call history via Web interface:

1. Click Directory→ Call History
2. Click Dialed List, Missed List, Received List, Forwarded List then you can see the history list.

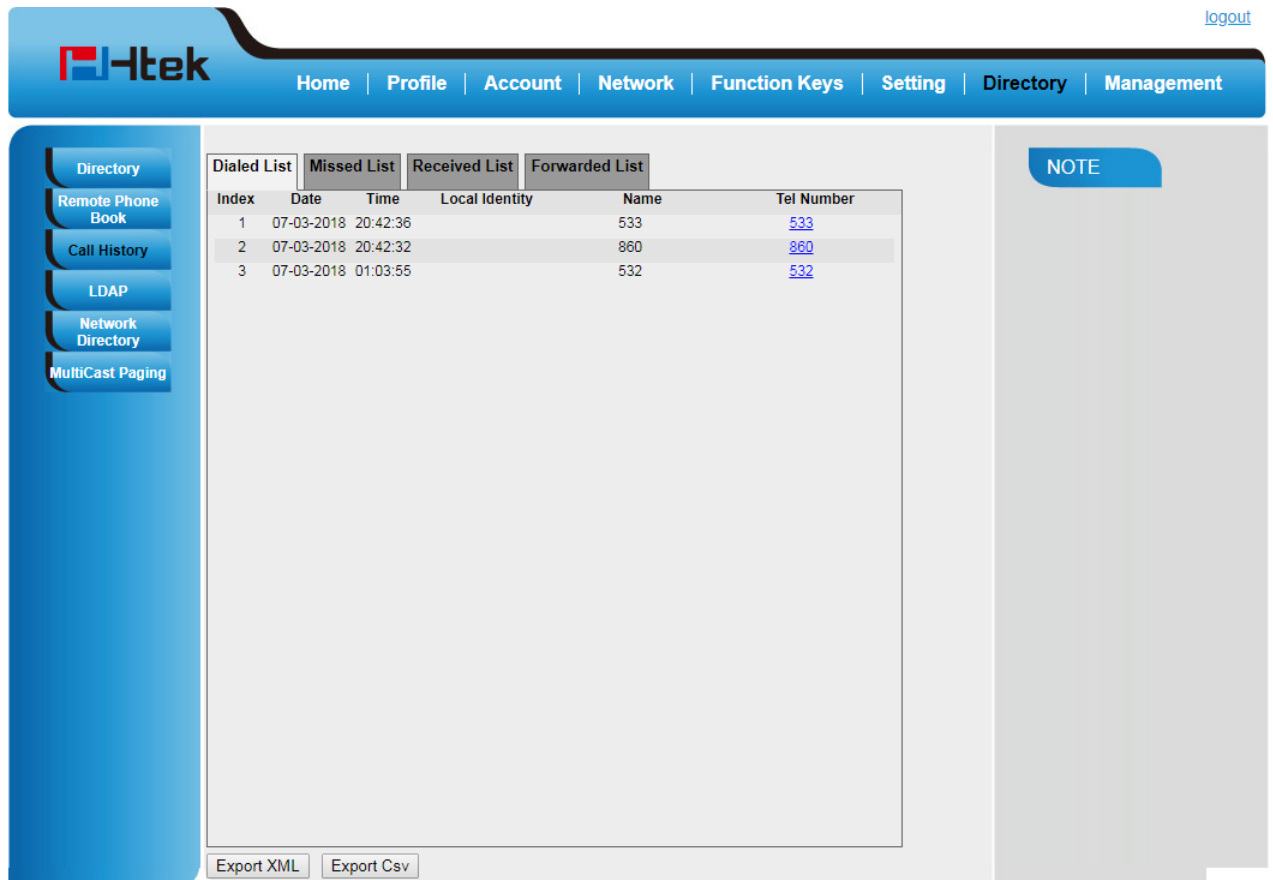

Dialed List		Missed List	Received List	Forwarded List	
Index	Date	Time	Local Identity	Name	Tel Number
1	07-03-2018	20:42:36		533	533
2	07-03-2018	20:42:32		860	860
3	07-03-2018	01:03:55		532	532

To dial a call from Call History via Web interface:

1. Click Directory→ Call History
2. Select the desired history item, and click Tel Number.
3. Then the call is dialed on phone.

[logout](#)

Htek

[Home](#) | [Profile](#) | [Account](#) | [Network](#) | [Function Keys](#) | [Setting](#) | [Directory](#) | [Management](#)

[Directory](#)
[Remote Phone Book](#)
[Call History](#)
[LDAP](#)
[Network Directory](#)
[MultiCast Paging](#)

Dialed List		Missed List		Received List		Forwarded List	
Index	Date	Time	Local Identity	Name	Tel Number		
1	07-03-2018	20:42:36		533	533		
2	07-03-2018	20:42:32		860	860		
3	07-03-2018	01:03:55		532	532		

[Export XML](#) [Export Csv](#)

NOTE

To Dial a call from Call History via Phone interface :

1. Press History soft key or press Menu → History → Local History
2. Press and to select the targeted one.
3. Press the Send soft key, or , or , or the corresponding line key.

Audio settings

Ring Tone

You can adjust the type and volume of the ring tone.

To adjust the Ring Tone Type via Phone interface

1. Press Menu → Settings → Basic Setting → Ring Tone.
2. Press and to select the aimed one.

- Press  or Save soft key to save the configuration.





To adjust the Ring Tone Type via Web interface

- Setting → Preference → Ring Tone
- Select the wanted one

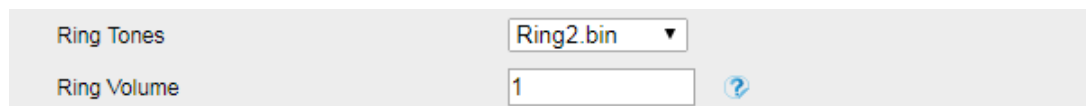
- Click  to save the configuration.



To configure Distinctive Ring Tone via Phone interface

- Press Directory
- Select the target contact
- Press Detail soft key to edit the contact.
- Press  and  to select the wanted Ring Tone for the contact
- Press Save soft key to save the contact.

To configure Distinctive Ring Tone via Web interface

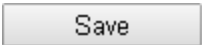
- Directory → Directory → Contact
- Choose the Ring Tone you want to use.
- Click  →  to save the configuration.

[logout](#)

Htek Home | Profile | Account | Network | Function Keys | Setting | Directory | Management

Directory

Remote Phone Book

Call History

LDAP

Network Directory

MultiCast Paging

Contact
BlackList
Hangup

Index	Display Name	Office Number	Mobile Number	Other Number	Account	
1	Luisa	860			Auto	<input checked="" type="checkbox"/>

Save
Delete
Move to Contact/blacklist

Contact

Name:

Office Number:

Mobile Number:

Other Number:

Account:

Ring:

Group:

Photo:

Edit

Import Local Contacts

Choose file:

Choose file: Show Title

GroupInfo

Group:

Ring:

NOTE

Add Contact/Blacklist
Fill in the contact information and the contact name can not be empty.

Delete Contact/Blacklist
Select a contact or more contacts and press the button 'Delete' to delete it.

Move to Contact/blacklist
Select a contact or more contacts and press the button 'move to Contact/Blacklist' to move it.

Import
Browse .xml and .csv format's file and import.

Export
Click Export button, then the phonebook.xml or phonebook.csv file will be downloaded.

Volume

You can adjust the volume for the phone by the volume keys: and .

To adjust the Ring tone volume via Phone interface



- Option 1: Press and on the idle page



- Option 2: Press and during the call is ringing.





To adjust the handset volume via Phone interface

Press  and  during a call in handset mode.





To adjust the headset volume via Phone interface

Press  and  during a call in headset mode.



To adjust the speaker Volume via Phone interface

Press  and  during a call in speaker mode.



Voice Mail Tone

This option can set whether to play the beep for phone's voice mail

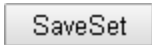
1. Click the Setting → Preference
2. Select On or Off for Voice Mail Tone.
3. Click  for the setting.

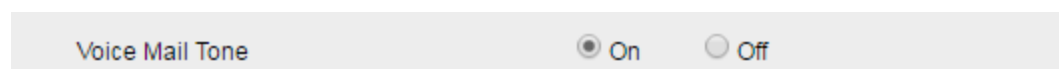

Play Hold Tone

When you hold the phone, Whether to play hold tone

1. Click the Setting → Preference
2. Set On or Off for Play Hold Tone.
3. Click  for the setting.

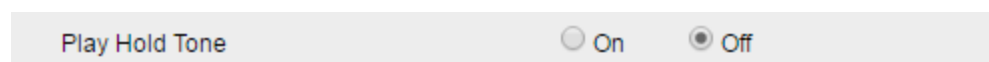

Play Hold Tone Delay

When you hold the phone. How many seconds to play beep?

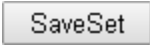
1. Click the Setting → Preference
2. Set Enable or Disable for Play Hold Tone Delay.
3. Click  for the setting.

Play Hold Tone Delay

System Settings

Dial Plan

Dial plan is a string of characters that governs the way this phone processes the inputs received from your phone keypad. This phone supports dial plan with following accept digits:

1,2,3,4,5,6,7,8,9,0,*,#

Grammar	Description
x	any digit from 0-9;
xx+	at least 2 digit number;
^	exclude;
,	hear dial tone;
[3-5]	any digit of 3, 4, or 5;
[147]	any digit 1, 4, or 7;
<2=011>	replace digit 2 with 011 when dialing.

To configure dial plan via Web interface :

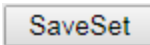
1. Click Account →Basic →Dial Plan.
2. Fill the value in dial plan field.
3. Click  to save the configuration.

[logout](#)

Htek

[Home](#) | [Profile](#) | [Account](#) | [Network](#) | [Function Keys](#) | [Setting](#) | [Directory](#) | [Management](#)

Basic

Account	Account 1
Account Status	Registered
* Account Active	<input type="radio"/> No <input checked="" type="radio"/> Yes
Profile	Profile 1
Label	<input type="text"/> ?
* SIP User ID	534 ?
* Authenticate ID	534 ?
* Authenticate Password ?
Name	<input type="text"/> ?
Local SIP Port	5060 ?
Use Random Port	<input checked="" type="radio"/> No <input type="radio"/> Yes
Voice Mail UserID	<input type="text"/> ?
Dial Plan	{[*]*+}
Eventlist BLF URL	<input type="text"/>
Shared Line	Disable
SCA Barge-In	Disable ?
Direct Call Pickup Code	<input type="text"/>
Group Call Pickup Code	<input type="text"/>
Feature Key Sync	Disable

NOTE

The * fields must be filled (requires a phone restart)

Basic:
The Basic parameters configured by the administrator.

Note:

Illegal input will fall back to default: {[*]*+}. For More, please refer to [dial plan](http://www.htek.com) on www.htek.com

Dial-Now Timeout

Dial-Now Timeout means that when you enter the number which matching with dial plan, it will dial out automatically after some time when you stop enter the number.

To configure Dial-Now Timeout via Web interface :

1. Click Webpage Setting → Preference
2. Fill the blank of Dial-Now Timeout: for example 5(seconds).(0 means dial out immediately).
3. Click the button to save the configuration

Dial-now Time-out (seconds) 

No Key Entry Timeout

No Key Entry Timeout means that when you enter the number, it will dial out automatically after some time when you stop enter the number.

To configure No Key Entry Timeout

1. Click Webpage Setting → Preference
2. Fill the blank of No Key Entry Timeout: for example 5(seconds).(0 means never timeout, you should press the send key the dial out the number.

3. Click the  button to save the configuration.

NO Key Entry Timeout(seconds) 

Emergency Call

Public telephone networks in countries around the world have a single emergency telephone number (emergency services number), that allows a caller to contact local emergency services for assistance when required. The emergency telephone number may differ from country to country. It is typically a three-digit number so that it can be easily remembered and dialed quickly. Some countries have a different emergency number for each of the different emergency services.

You can specify the emergency telephone numbers on the IP phone for contacting the emergency services in an emergency situation.

To configure emergency call via Web interface:

1. Click Setting→ Features→ Phone Lock
2. Enter the emergency services number in the Emergency field
3. Click  to save the configuration.

Phone Lock

Keypad Lock All Keys ▼

Phone Unlock Pin(0~15dial)

Auto Lock Time-Out(15~3600s) 15

Emergency 110,120,119

Label Scroll

When setting function keys, you need to set the label of the function keys. If the words are too long to show on the label, you can use this function to make labels scroll. Another approach is to set the labels to long label mode.

To configure Label Scroll via Web interface :

1. Click the Setting → Preference
2. Select Enable or Disable for Label Scroll.
3. Click SaveSet for the setting.

Lable Scroll Disable ▼

Use # As Dial Key Disable

Enable ?

Show Missed Calls

Whether to show missed call notification on LCD

To configure Show Missed Calls via Web interface :

1. Click the Setting → Preference
2. Select Yes or No for Show Missed Calls.
3. Click SaveSet for the setting.

Show Missed Calls Yes No ?

Auto Logout Time

Set the Web login timeout

1. Click the Setting → Preference
2. Set number 1~5000 min for Auto Logout Time.
3. Click for the setting.

Auto Logout Time (1 ~ 5000 min)	<input type="text" value="6"/>
---------------------------------	--------------------------------

Reboot in Talking

This function is to allow reboot during the calls or not

1. Click the Setting → Preference
2. Set Enable or Disable for Reboot in Talking.
3. Click for the setting.

Reboot in Talking	<input type="text" value="Disable"/>
-------------------	--------------------------------------

Detect IP Conflict

LCD can display message when IP conflict

1. Click the Setting → Preference
2. Set Enable or Disable for Detect IP Conflict.
3. Click for the setting.

Detect IP Conflict	<input type="text" value="Enable"/>
--------------------	-------------------------------------

Redial Mode

Call redial has two ways:(1) To redial the last placed call from the IP Phone (2) To redial the call from all calls list

1. Click the Setting → Preference
2. Set Direct Mode or Select Mode for Redial Mode.

- Click for the setting.

Redial Mode	<input checked="" type="radio"/> Direct Mode <input type="radio"/> Select Mode
-------------	---

Keypad Lock

To enable Keypad Lock via Phone interface

- Press Menu--Settings--Advanced Setting--Phone Setting--Lock
- Press and key or Info or Switch to change choose lock type: All Keys, Menu Key, Function Key, Lock & Answer
- Press Save or OK key to save the configuration.

To disable Keypad Lock via Phone interface

- Press Menu--Settings--Advanced Setting(Password: admin)--Phone Setting--Lock
- Press and key or Info or Switch to change to choose Off.
- Press Save or OK key to save the configuration.

To enable Keypad Lock via Web interface

- Click Web interface Setting → Features
- To choose the Phone Lock.
- To fill the Phone Unlock Pin and Auto Lock Time-Out
- Fill the Emergence Number, when the phone is Lock, only Emergency Number can be sent.
- To click SaveSet to save the configuration.

Phone Lock	
Keypad Lock	<input type="text" value="All Keys"/>
Phone Unlock Pin(0~15digial)	<input type="text" value="....."/>
Auto Lock Time-Out(15~3600s)	<input type="text" value="15"/>
Emergency	<input type="text" value="110,120,119"/>

To Disable Keypad Lock via Web interface

1. Click Web interface Setting → Features
2. To choose Disable for the Phone Lock.
3. To click SaveSet to save the configuration.

Suppress DTMF Display

In order to ensure safety in Call process, you can choose whether to hide DTMF

1. Click the Setting → Preference
2. Select On or Off for Suppress DTMF Display.
3. Click  for the setting.

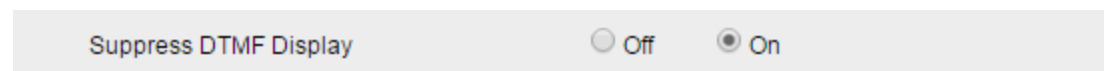

Suppress DTMF Display Delay

In order to ensure safety in Call process, you can choose whether to hide DTMF

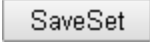
1. Click the Setting → Preference
2. Select On or Off for Suppress DTMF Display Delay.
3. Click  for the setting.

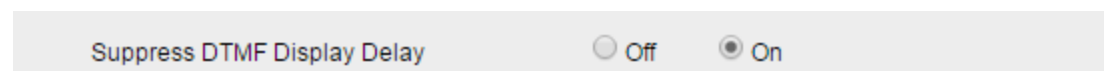

Check-Syn With Authenticate

If this option is enabled, the server needs to be authenticated before the phone agrees to synchronize.

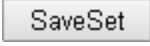
1. Click the Setting → Preference
2. Set Enable or Disable for Check-Syn With Authenticate.
3. Click  for the setting.

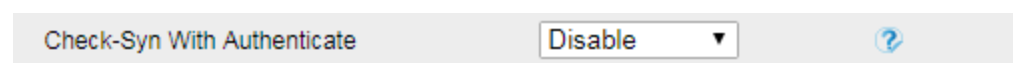

Other features settings

Action URL

To configure action url via Web interface :

1. Click Setting→ Action URL
2. Filled the needed value in the necessary blank.
3. Click to save the setting.





Click [Action URL](#) for more how to use, or check on www.htek.com

Setting Name	Input Field	Help Icon
Setup Completed	<input type="text"/>	?
Log On	<input type="text"/>	?
Log Off	<input type="text"/>	?
Register Failed	<input type="text"/>	?
Off Hook	<input type="text"/>	?
On Hook	<input type="text"/>	?
Incoming Call	<input type="text"/>	?
Outgoing Call	<input type="text"/>	?
Call Established	<input type="text"/>	?
Call Terminated	<input type="text"/>	?
Open DND	<input type="text"/>	?
Close DND	<input type="text"/>	?
Open Always Forward	<input type="text"/>	?
Close Always Forward	<input type="text"/>	?
Open Busy Forward	<input type="text"/>	?
Close Busy Forward	<input type="text"/>	?
Open No Busy Forward	<input type="text"/>	?
Close No Busy Forward	<input type="text"/>	?
Transfer Call	<input type="text"/>	?
Blind Transfer call	<input type="text"/>	?
Attended Transfer Call	<input type="text"/>	?
Hold	<input type="text"/>	?
Unhold	<input type="text"/>	?

Softkey Layout

This feature mainly defines which shown on the soft key in some status. For example, what the soft key displays when dialing, or talking.

To configure Soft key via Web interface :

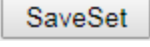
1. Click Setting→ Softkey Layout
2. Select Enable for Custom Softkey
3. Select Call States.
4. Select the feature form the disable key to enable key field by 
 moves the Disable key to Enable field.  moves the Enable key, and it will back to Disable field.
5. Click  or  to change to position or each feature.
6. Click  to save the configuration.

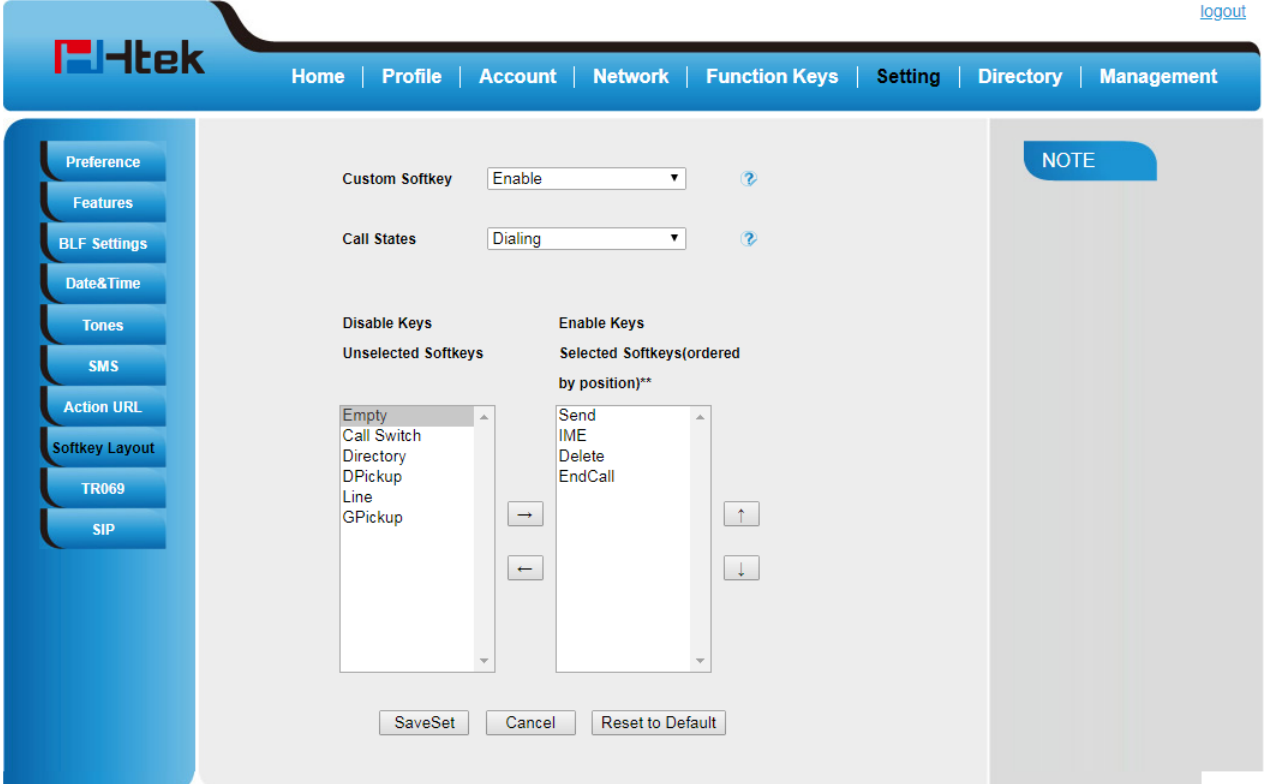

The screenshot shows the Htek web interface for configuring Softkey Layout. The top navigation bar includes Home, Profile, Account, Network, Function Keys, Setting, Directory, and Management. The left sidebar lists various settings: Preference, Features, BLF Settings, Date&Time, Tones, SMS, Action URL, Softkey Layout (selected), TR069, and SIP. The main content area shows the following configuration options:

- Custom Softkey: Enable
- Call States: Dialing

Below these are two columns for key management:

- Disable Keys (Unselected Softkeys):** Empty, Call Switch, Directory, DPickup, Line, GPickup
- Enable Keys (Selected Softkeys(ordered by position)**):** Send, IME, Delete, EndCall

Navigation buttons between the lists include right and left arrows. At the bottom, there are buttons for SaveSet, Cancel, and Reset to Default. A NOTE box is visible on the right side.

Note:

1. When there more than 5 items in the Enable field, the last soft key will display More, and last two item will show in the next page soft key, you can check by press more.

Programmable Key

For the default keys as Soft keys, Navigation keys and so on, you can define them as some specific feature, and it works only on the idle page.

To configure Programmable Key via Web interface :

1. Click Function Keys→ Programmable Keys
2. Select the desired Key to set.
3. Click to save the setting.
4. By clicking , all setting of the keys will be back to default.

[logout](#)

Home | Profile | Account | Network | **Function Keys** | Setting | Directory | Management

Line Key

Programmable Key

EXP KEY

Key	Type	Label	Account	Value
SoftKey1	History		Account 1	
SoftKey2	Directory		Account 1	
SoftKey3	DND		Account 1	
SoftKey4	Menu		Account 1	

Key	Type	Account	Value
Up	History	Account 1	
Down	Directory	Account 1	
Left	Switch Account Up	Account 1	
Right	Switch Account Dowl	Account 1	
OK	Status	Account 1	
Cancel	N/A	Account 1	
MUTE	N/A	Account 1	
CONF	N/A	Account 1	
TRAN	Forward	Account 1	
HOLD	N/A	Account 1	
Speaker	Speaker	Account 1	
Headset	Headset	Account 1	
VM	VM	Account 1	
Volume Up	Volume Up	Account 1	
Volume Down	Volume Down	Account 1	



NOTE

Basic Call Features



Place a Call

There are three ways to dialing a call: Handset, Headset and Hands-free speakerphone.



To place a call by Handset

1. Pick up the handset, or press a line key and dial the necessary number.
2. Press  or  or press the send soft key, then the call is sending.

To place a call by Headset:

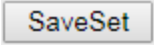

1. Press the  (light is Green)
2. Enter the desired number.
3. Press  or  or press the Send soft key, then the call is sending.

Using headset to place and answer calls for all time

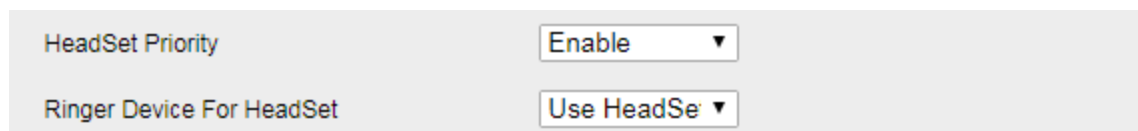



1. Click webpage Setting → Preference
2. HeadSet Priority → Enable
3. Ringer Device For HeadSet → User Headset
4. Click  to save the setting.
5. Press 



Placing a call by hands-free speakerphone

1. Press the , or press the Line key, then you can hear the dial tone.
2. Press the number.
3. Press  or  or press the Send soft key, then the call is sending.

To place a call by call history or Directory

1. Press the History/ DIR soft key (On the idle page) or Menu → History /Directory
2. Press  and  to select the targeted one.
3. Press the Send soft key, or , or , or the corresponding line key, then the call is sending.

Note:

1. The  key is set to be a send key. For more information, refer to the Key as Send on page
2. During the call, you can also change among Headset, Handset or Free-speaker mode.

Making two calls with one line and one account

1. Press a line key and dial phone number, then make a call.
2. Press Hold soft key and then press New Call soft key.
3. Dial another phone number,
4. Press the Send soft key, or , then make the second call.



End a Call

Here shows to end a call during three modes:



To end a call by Handset

Press the End Call soft key or hang up the handset, or press .

To end a call under Headset Mode

Press the End Call soft key or press , or press .

To end a call under hands-free speakerphone Mode

Press the End Call soft key or press , or press .

Note:

During the conference, to end the call is same as mentioned above.

Receive a Call

There are three ways to receive a call when the phone is ringing:

To receive a call by handset

Pick up the handset and now the conversation is built.

To receive a call by headset

Press  and now the conversation is built.

To receive a call by hands-free speaker

1. Option 1: Press  directly.
2. Option 2: Press Answer soft key.
3. Option 3: Press the Line key (flashes red).

Moreover, some other action can be done by soft key when the call is coming.

1. Press the Reject soft key to reject the call. Or press  to reject the current call.
2. Press Forward soft key to forward to another phone.
3. Press Silence soft key, and then the call will keep silent, no ring tone display.

Incoming Call Show Mode

There are two incoming call show modes for this phone:

1. name and number of the contacts
2. name and number of the incoming call and the account which is connecting

To set incoming call show mode via Web interface :

1. Click Setting → Preference
2. Select the desire mode for the incoming call show mode
3. Click  to save the setting.

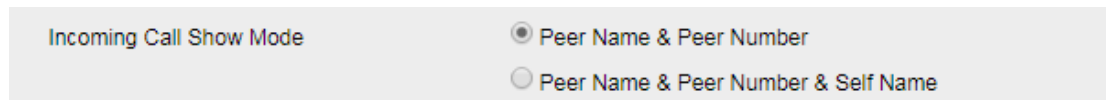

Incoming Call Show Mode

Peer Name & Peer Number

Peer Name & Peer Number & Self Name

Auto Answer

Enable auto answer feature, you will answer all incoming call automatically.

To enable Auto Answer via Web interface

1. To Click Profile → Advanced
2. To choose Yes for the Auto Answer.
3. To click SaveSet to save the configuration.

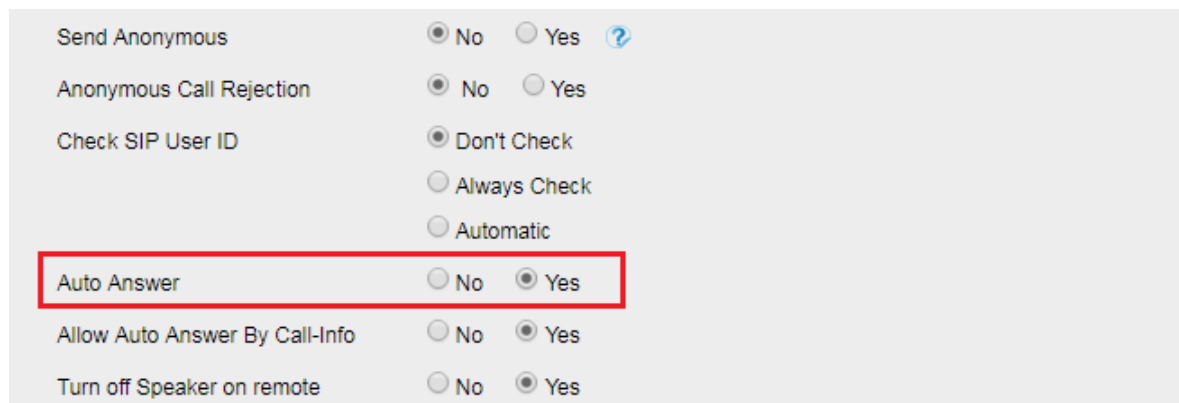

Send Anonymous No Yes 

Anonymous Call Rejection No Yes

Check SIP User ID Don't Check

Always Check

Automatic

Auto Answer No Yes

Allow Auto Answer By Call-Info No Yes

Turn off Speaker on remote No Yes

To Disable Auto Answer via Web interface

1. To Click Profile → Advanced
2. To choose No for the Auto Answer.
3. To click SaveSet to save the configuration.

Call Hold

When use hold feature, the Hold icon will show on the display.

To make a call on hold during three modes:

To hold a call under handset mode:

1. Press Hold soft key to hold the current call.



2. Press Resume soft key to resume the call on hold.



To hold a call under headset mode:

1. Press Hold soft key to hold the current call.
2. Press Resume soft key to resume the call on hold.

To hold a call during the speaker mode:

1. Press Hold soft key to hold the current call.
2. Press Resume soft key to resume the call on hold.

Call Transfer

This phone supports blind, attended and Semi-Attended Transfer.

Blind Transfer

When you use this feature, you can transfer

1. Press Transfer soft key during the conversation, the call is on hold now.



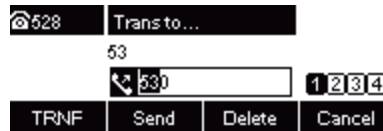

2. Enter the number that transfers to.



3. Press Transfer soft key , and now the blind transfer completed.

Attended Transfer



When you use this feature, you can

1. Press Transfer soft key during the conversation, the call is on hold now.
2. Enter the number that transfer to, and press the Send soft key or  or .
3. Start the second conversation, press the Transfer soft key, then transfer completed.

NOTE:

To transfer calls across SIP domains, SIP service providers must support transfer across SIP domains. Blind transfer will usually use the primary account SIP profile.

Semi-Attended Transfer

1. Press the Transfer soft key during the conversation, the call is on hold now.
2. Enter the number transfer to, and then press  or , then you can hear the ring tone.
3. Press the Transfer soft key, and now the Semi-attended transfer completed.

BLF Transfer

1. Set a Programmable Key or line key is set as BLF. For how to set BLF, please refer to [BLF](#)
2. Press the Transfer soft key during the conversation, the call is on hold now.
3. Press BLF key then realize blind, attended and Semi-Attended Transfer. (Webpage--Setting--Features--Transfer Settings)

Transfer Settings

Blind Transfer On Hook On Off

Semi-Attended Transfer On Off

Attended Transfer On Hook On Off

Transfer Mode via DSSkey Attended Transfer ▼

Attended Transfer
Blind Transfer
New Call

Hold Transfer On Hook On Off

Hold transfer on hook:

1. Setting → Features → Transfer Setting: Hold Transfer On Hook: ON.
2. A place a call to B, B answer, A press the hold soft key and place a call to C, A cancel the call when C is ringing or answering, then C and B in the same call and the transfer is successful.

Transfer Settings

Blind Transfer On Hook On Off

Semi-Attended Transfer On Off

Attended Transfer On Hook On Off

Transfer Mode via DSSkey Attended Transfer ▼

Hold Transfer On Hook On Off

Hold transfer on Three Way conference:

1. Setting → Preference → Three Way Call Release Type: Transfer.
2. A place a call to B, B answer, A place a call to C again, C answer, A press the Conference soft key then A, B and C will establish meeting.
3. A press the End Call soft key or on-hook to exit the meeting in the process of talking.
4. Then B and C will continue to talk.

Three Way Call Release Type Transfer ▼

Hung Up
Transfer

Detect IP Conflict

Transfer to New Call via Web interface

1. Click Setting → Features
2. Select Transfer Mode via DSS key: New Call
3. Select the desired Line Key and select Transfer in the Type.

4. Enter the phone number in the Value field.

Transfer Settings

Blind Transfer On Hook On Off

Semi-Attended Transfer On Off

Attended Transfer On Hook On Off

Transfer Mode via DSSkey New Call ▾

Hold Transfer On Hook

Attended Transfer

Blind Transfer

New Call

[logout](#)

Home
Profile
Account
Network
Function Keys
Setting
Directory
Management

Line Key

Programmable Key

EXP KEY

Line Label Length Default ▾ Line Page Indicator Disable ▾

BLF list MODE Manually ▾ line key as cancel Disable ▾

Line	Type	Mode	Value	Label	Account	Extension
Key1	Line ▾	Default ▾			Account 1 ▾	
Key2	BLF ▾	Default ▾	527		Account 1 ▾	*04

NOTE



Note: if the person that wanted to be spoken to do not want to answer the call, then the person that answered the coming call could use this function.

Call Conference

This IP Phone supports up to 5-way conference.

5-way conference

1. Assuming that call party **A** and **B** are in conversation. **A** wants to bring **C**, **D** and **E** in a conference
2. **A** press the Conference soft key, the call is placed on hold.
3. **A** enter the number of **C** and then press Send soft key or .
4. **C** answer the call.
5. **A** press Conference soft key, then **A**, **B** and **C** are now in a conference.(and now this is **3-way conference**)
6. **A** press the Conference soft key, the current 3-way conference is placed on hold.

7. **A** enter the number of **D** and then press Send soft key or .
8. **D** answer the call.
9. **A** press the Conference soft key, then **A, B, C** and **D** are now in a conference.(and now this is **4-way conference**)
10. **A** press the Conference soft key, the call is placed on hold.
11. **A** enter the number of **E** and then press Send soft key or .
12. **E** answering the call.
13. **A** press the Conference soft key, then **A, B, C, D** and **E** are now the **5-way conference** is built.
14. **A** end the call, the conference is finished.

Note:

1. If **C** does not answer the call, **A** can back to continue the conversation with **B**;
2. Once **A** hangs up the call, the conference is ended, while if **B** or **C** drops the call, **A&C** or **A&B** conversation continues.
3. The conference feature is not available on all servers. For more information, contact your system administrator.
4. To realize the 5 way conference, the line should be all available.

Call Forward

This phone supports static forward (always forward, busy forward and no answer forward) and dynamic forward

To configure static forward

To configure always forward

With this feature, all incoming calls will forward immediately to configured number.

1. Press Menu → Features → Call Forward →Always Forward.



- Press  and  or press Info/Switch soft key to select the enable choice



- Enter the Forward To number.
- Press  or Save soft key to save the configuration.

To configure busy forward

With this feature, the incoming calls are immediately forwarded if the phone is busy.



- Press Menu → Features → Call Forward → Busy Forward.
- Press  and  or press Info/Switch soft key to select the enable choice.



- Enter the Forward To number.
- Press  or Save soft key to save the configuration.

To configure no answer forward

No Answer Forward: Incoming calls are forwarded if not answered after some time.

- Press Menu → Features → Call Forward → No Answer Forward.
- Press  and  or press Info/Switch soft key to select the enable choice



- Enter the Forward To number and After Ring Times.
- Press  or Save soft key to save the configuration.

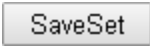

When the Forward feature is enabled, the Forward Icon will display on Top of the LCD.

To configure Forward via Web interface

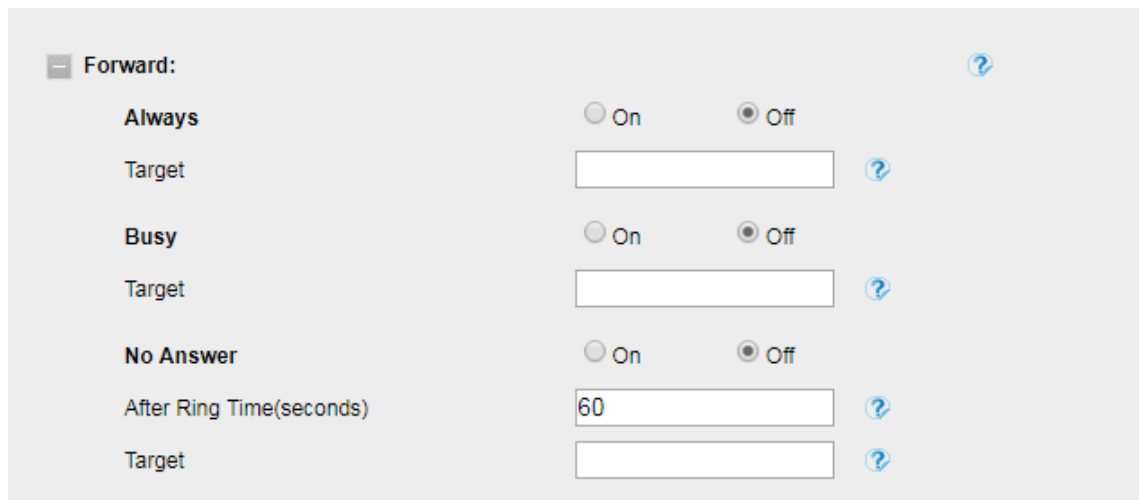
1. Setting → Features
2. Click On for the Always/Busy/No Answer
3. Fill the Forward to Number
4. Fill the After Ring Time
5. Click  to save the configuration



To cancel the forward feature via Phone interface

1. Press Menu → Features → Call Forward → Always/Busy/No Answer Forward
2. Press  and  or press Info/Switch soft key to select the disable choice
3. Press  or Save soft key to save the configuration.

To cancel the forward feature via Web interface

1. Setting → Features
2. Click Off for the Always/Busy/No Answer
3. Click  to save the configuration

To configure dynamic forward

Forward an incoming call during the ringing.

1. When the phone is ringing, press FWD soft key.



2. Enter the forward number or select the desired number from Directory soft key (Precondition: local directory has one or more contacts).
3. Press  or press the Send soft key, then the call is forwarded.

Note:



If the Programmable Key or line key is set as BLF, when an incoming call ringing, press this BLF key directly to realize the dynamic forward.

You can choose a desired forward number from the Directory when you press the Forward key.

Call Return

This feature allows you to dial the last phone call you received.

To configure the Call Return via Phone interface

1. Press Menu → Features → Function Keys → Line Keys as Function Keys → Line Key2(for example)
2. Press  and  or press Switch soft key to select the Call Return in the Type field.
3. Press  or Save soft key to save the configuration

To configure the Call Return via Web interface

1. Click Function keys → Line Key.
2. Select the desired Line Key and select Call Return in the Type.

- Click the button to save the configuration.

Call Back

When this option is set, if the phone you call is busy and does not set call waiting or voice mail, your LCD screen will prompt for call-back, as shown in figure



If you press the callback, the phone will dial the Callback phone number.

To configure the Call Back via Web interface

- Click Setting → Features → Callback .
- Fill the Callback phone number.
- Click to save the configuration.

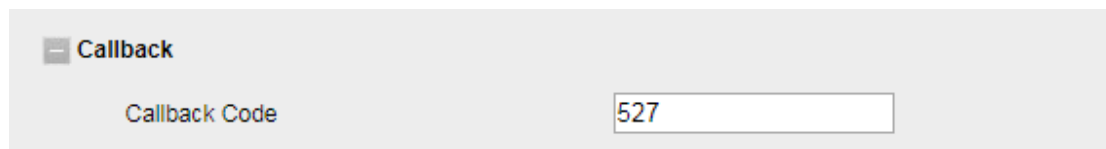

Call Waiting Tone

- Click Setting → Features
- Select Call Waiting: On and Call Waiting Tone: On

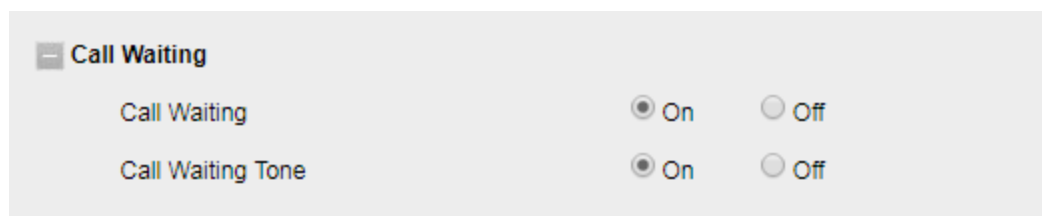

To Change the Call Waiting Tone time via Web interface

- Click Setting → Tones

[logout](#)

Htek

[Home](#) | [Profile](#) | [Account](#) | [Network](#) | [Function Keys](#) | [Setting](#) | [Directory](#) | [Management](#)

[Preference](#)
[Features](#)
[BLF Settings](#)
[Date&Time](#)
[Tones](#)
[SMS](#)
[Action URL](#)
[Softkey Layout](#)
[TR069](#)
[SIP](#)

Select Country	<input type="text" value="Custom"/>
Dial Tone	<input type="text" value="f1=350@-13,f2=440@-13,c=0/0;"/>
Ringback Tone	<input type="text" value="f1=440@-19,f2=480@-19,c=2000/4000;"/>
Busy Tone	<input type="text" value="f1=480@-24,f2=620@-24,c=500/500;"/>
Reorder Tone	<input type="text" value="f1=480@-24,f2=620@-24,c=250/250;"/>
Confirmation Tone	<input type="text" value="f1=350@-11,f2=440@-11,c=100/100-100/100-100/100;"/>
Call Waiting Tone	<input type="text" value="f1=440@-13,c=300/10000-300/10000-0/0;"/>

Syntax: f1=freq@vol, f2=freq@vol, c=on1/off1-on2/off2-on3/off3; [...]
 Note: freq: 0 - 4000Hz; vol: -30 - 0dBm

NOTE

Select Country:
 Select your country to generate the standard call tones. Or select Custom to customize the call tones.

2. Change the Tone Time as you want (for example 3s)

Call Waiting Tone	<input type="text" value="f1=440@-13 c=300/10000-300/10000-0/0;"/>
-------------------	--

Hide Caller ID

Just enable the unknown/hidden caller feature, by enabling Anonymous call feature thereby the receiver won't be able to know who is calling them.

To configure anonymous call

1. Press Menu → Features → Anonymous Call → Account ID 1
2. Press and or press Info/Switch soft key to select the enable choice in Anonymous Call filed.
3. Enter the Call On Code (optional), Call Off Code (optional).
4. Press or Save soft key to save the configuration.

To cancel anonymous call feature



1. Press Menu → Features → Anonymous Call → Account ID 1
2. Press and or press Info/Switch soft key to select the disable choice in Anonymous Call filed.

3. Press  or Save soft key to save the configuration.



Reject Anonymous

If you do not want to be disturb by anonymous calls, you can set the reject anonymous call features, so you will not hear the unknown calls

To configure rejecting anonymous call

1. Press Menu →Features →Anonymous Call →Account ID 1
2. Press  and  or press Info/Switch soft key to select the enable choice in Rejection filed.
3. Enter the Reject On Code (optional), Reject Off Code (optional).
4. Press  or Save soft key to save the configuration

To cancel rejecting anonymous call

1. Press Menu →Features →Anonymous Call →Account ID 1
2. Press  and  or press Info/Switch soft key to select the disable choice in Rejection filed.
3. Press  or Save soft key to save the configuration.

Call Mute

When you use the Mute feature, the other parties will not hear your voice while you can hear their voice. Call mute applies to all modes (handset, headset, and speakerphone).

To mute the call during a call (including a conference call)

1. Press the Mute key , then the Mute key glows green, and the LCD display Mute Icon.

2. To disable the mute function, press  again.

DND

When you use the DND feature, the phone is to reject all incoming calls automatically and you can see the DND icon shown on the Top of the LCD on idle page.

To enable DND feature via Phone interface

Press the DND soft key when the phone is idle, and then DND icon shown on the LCD.

To disable DND feature via Phone interface

Press the DND soft key again, and then there is no DND icon on the LCD.

Hot Line

To configure Hot Line

1. Press Menu → Features → Hot Line
2. Enter the Number and Delay time (as present, we support off hook auto dial).
3. Press  or Save soft key to save the configuration

To configure Hotline auto dial via Web interface

1. Setting → Features.
2. Fill the number in the Hotline Number and Hotline Time-out.
3. Click  to save the configuration.

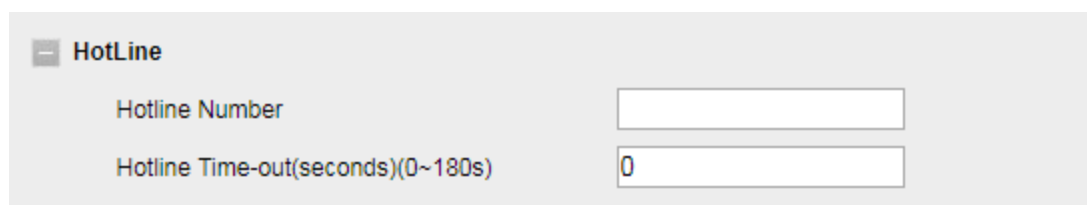

The screenshot shows a web interface for configuring the HotLine feature. It has a title bar with a minus sign and the text "HotLine". Below the title bar, there are two input fields. The first field is labeled "Hotline Number" and is empty. The second field is labeled "Hotline Time-out(seconds)(0~180s)" and contains the number "0".

Delete the hotline number and save the configuration, then now the Hotline auto dial is cancelled.

Auto Redial

When this option is set, if the phone you call is busy and does not set call waiting or voice mail, your LCD screen will prompt for Auto Redial, as shown in figure.



If you press OK, your LCD will prompt Auto Redial Interval and Auto Redial Times

To configure Auto Redial via Web interface

1. Click Setting → Features → Auto Redial
2. Select On or Off for Auto Redial.
3. Fill the number 1~300 seconds for the Auto Redial Interval.
4. Fill the number 1~300 times for the Auto Redial Times.
5. Click to save the configuration.



The image shows a web interface configuration for "Auto Redial". It includes a section header "Auto Redial" with a minus sign icon. Below it are three rows of configuration options:

- "Auto Redial" with radio buttons for "On" (selected) and "Off".
- "Auto Redial Interval (1~300s)" with a text input field containing the number "3".
- "Auto Redial Times (1~300)" with a text input field containing the number "3".

Function Keys Features Settings

Line

It works same as Line keys.

To configure Line Feature via Web interface

1. Click Function keys → Line Key.

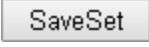

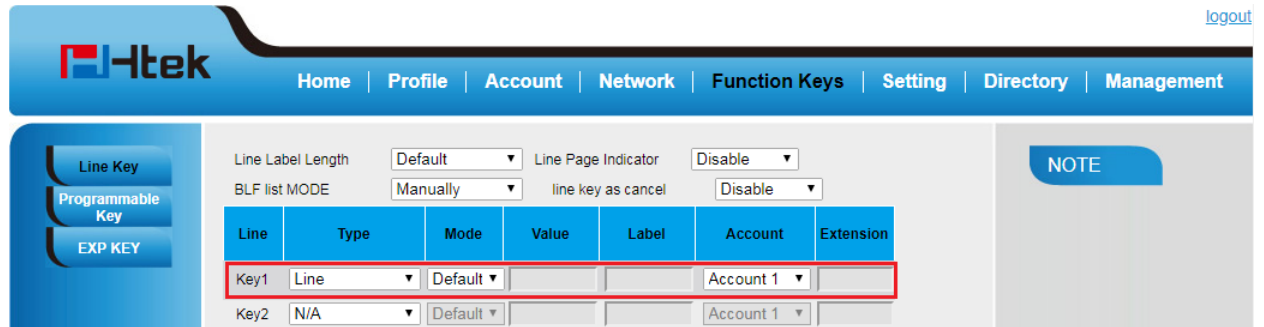
2. Select the wanted Key and set as Line.
3. Select the Account.
4. Click the  button to save the configuration.



Speed Dial

With this feature, you can dial one number by pressing the configured speed dial key.

To configure Speed Dial feature via Phone interface

1. Press Menu → Features → Function Keys → Line Keys as Function Keys → Line Key2(for example)
2. Press  and  key to select the Speed Dial in the Type field.
3. Enter the targeted Number.
4. Press  or Save soft key to save the configuration

Then the selected Line Key will work as Speed Dial.

To configure Speed Dial feature via Web interface

1. Click Function keys → Line Key.
2. Select the wanted Line Key and set as Speed Dial.
3. Enter the desired phone number in the Value field.
4. Select the Account

- Click the to save the configuration.

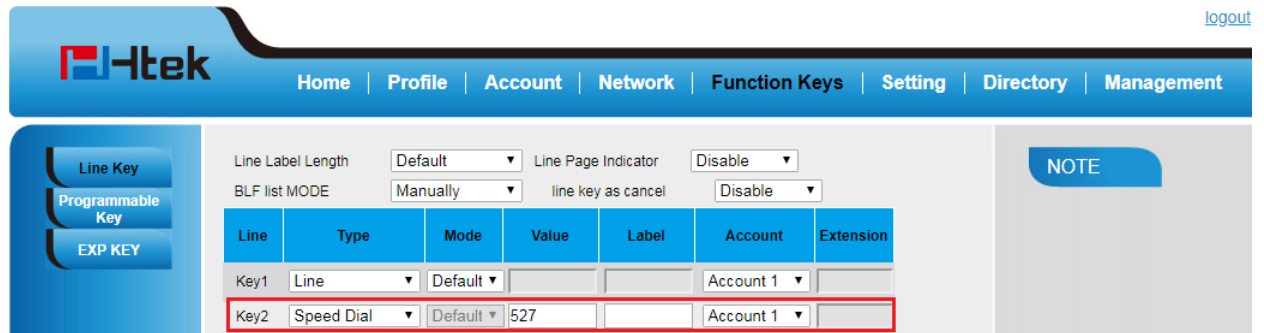

BLF

You can use the BLF (Busy Lamp Field) feature to monitor a specific extension number whether the extension is busy or free.

- When the extension you are monitoring is idle, the light is steady green.
- When the monitored extension is ringing, the light is blinking red, press the BLF key to pick the phone up directly.
- When the monitored extension is calling or in a conversation, the light is steady red.

To configure a BLF key by phone

- Press Menu → Features → Function Keys → Line Keys as Function Keys → Line Key2 (for example).
- Select the targeted Line Key.
- Press and or press Switch soft key to select the BLF in the Type field.
- Enter the targeted Value Number.
- Press and to select the Account ID.
- Enter the Pickup Code.
- Press or Save soft key to save the configuration

To configure a BLF key by web

1. Click Function keys → Line Key.
2. Select the desired Line Key and select BLF in the Type.
3. Enter the monitored phone number in the Value field.
4. Select the Account
5. Filled the Extension.
6. Click to save the configuration.

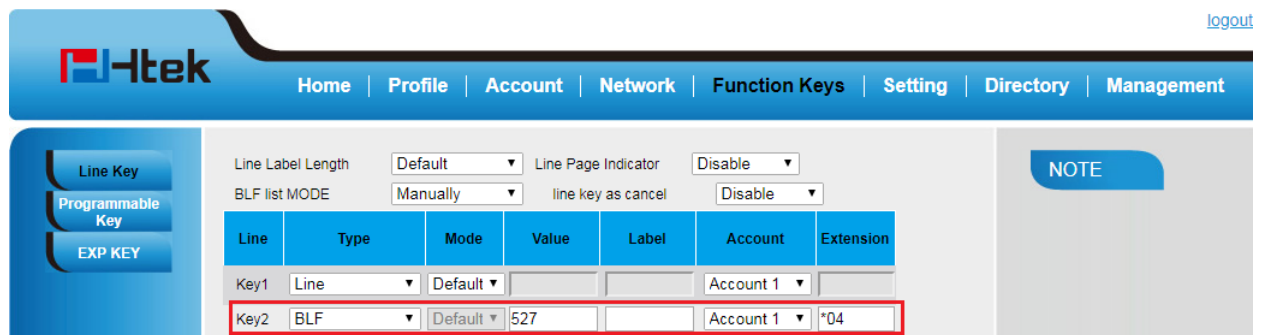

[logout](#)

Htek Home | Profile | Account | Network | **Function Keys** | Setting | Directory | Management

Line Key
Programmable Key
EXP KEY

Line Label Length: Line Page Indicator:
 BLF list MODE: line key as cancel:

Line	Type	Mode	Value	Label	Account	Extension
Key1	Line	Default			Account 1	
Key2	BLF	Default	527		Account 1	*04

NOTE

Note:
 This feature is not available on all servers. For more information, contact your system administrator.
 After setting the BLF key, do not need to restart the phone.

BLF List

To configure BLF List via Web interface:

1. Login and click Account→Basic
2. Fill the Eventlist BLF URL and click to save the configuration.

[logout](#)

[Home](#) | [Profile](#) | [Account](#) | [Network](#) | [Function Keys](#) | [Setting](#) | [Directory](#) | [Management](#)

Basic

Account	Account 1 ▼
Account Status	Registered
* Account Active	<input type="radio"/> No <input checked="" type="radio"/> Yes
Profile	Profile 1 ▼
Label	<input type="text"/> ?
* SIP User ID	531 ?
* Authenticate ID	531 ?
* Authenticate Password ?
Name	<input type="text"/> ?
Local SIP Port	5060 ?
Use Random Port	<input checked="" type="radio"/> No <input type="radio"/> Yes
Voice Mail UserID	<input type="text"/> ?
Dial Plan	{{[x*]+}
Eventlist BLF URL	<input type="text"/>
Shared Line	Disable ▼
SCA Barge-In	Disable ▼ ?
Direct Call Pickup Code	*04
Group Call Pickup Code	<input type="text"/>
Feature Key Sync	Disable ▼

NOTE

The * fields must be filled (requires a phone restart)

Basic:
The Basic parameters configured by the administrator.

3. To configure BLF List Keys

3.1 Click→ Function Keys→ Line Key

3.2 Select the BLF List in the Type Field.

3.3. Select Account

3.4 Click SaveSet to save the configuration and then restart the Phone.

For more information, please check [BLF list Note](#) on www.htek.com web.

Voice Message

To configure the Voice mail feature via Phone interface

1. Press Menu →Messages →Voice Mail →Set Voice Mail.



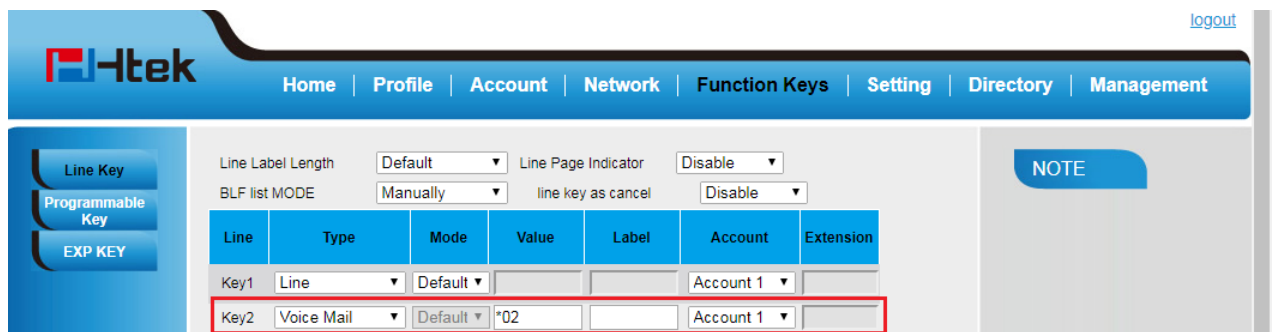

2. Enter the Account NO.1/2/3/4/5/6
3. Press  or Save soft key to save the configuration

To configure Voice Mail Line Key via Web interface:

1. Click Function keys → Line Key.
2. Select the wanted Key.
3. Enter the desired voicemail feature codes in the Value field.
4. Fill the Label name to be displayed on LCD.
5. Select the Account.
6. Click  to save the configuration.



To configure a Voice mail key by Phone interface:

1. Press Menu →Features →Function Keys →Line Keys as Function Keys→ Line Key2(for example).
2. Select the targeted Line Key.
3. Press  and  key to select the Voice mail in the Type field.
4. Enter the Value.
5. Press  and  key to select the Account ID.

6. Press  or Save soft key to save the configuration

To leave a voice mail:

You can leave a voice mail when the receiver is busy or its inconvenient for them to answer the call. Follow the voice prompt from the system server to leave a voice mail, and then hang up.

To listen to voice mails:

When the Phone interface prompts receiving new voice mail's icon, the power indicator LED flashes red(Setting->Preference: Enable Voice Message Status).

1. Pressing  or the targeted Line Key to dial out the voice mail access code.
2. Follow the voice prompt to listen to voice mail.

To view the voicemail via Phone interface

Press Menu->Messages->Voice Mail->View Voice Mail.

The LCD screen displays the amount of new and old voice mails

```
1.861:1 new, 2 old, 0 new urgent, 0 old urgent
2.Account2:Not Registered
3.Account3:Not Registered
Back
```

Note:

This feature is not available on all servers. For more information, contact your system administrator.



Before listening to voice mails, make sure the voice mail access code has been configured.



When all new voice mails are retrieved, the power indicator LED will go out.

Direct Pickup

With this feature, you can pick up the set line when it ringing.

To configure Direct Pickup feature via Phone interface

1. Press Menu →Features →Function Keys →Line Keys as Function Keys → Line Key2(for example)
2. Press  and  key to select the PickUP in the Type field.

3. Enter the value.
4. Press  and  key to select the Account ID.
5. Press  or Save soft key to save the configuration

Then the selected Line Key will work as Direct Pickup.

To configure Direct Pickup feature via Web interface

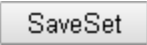

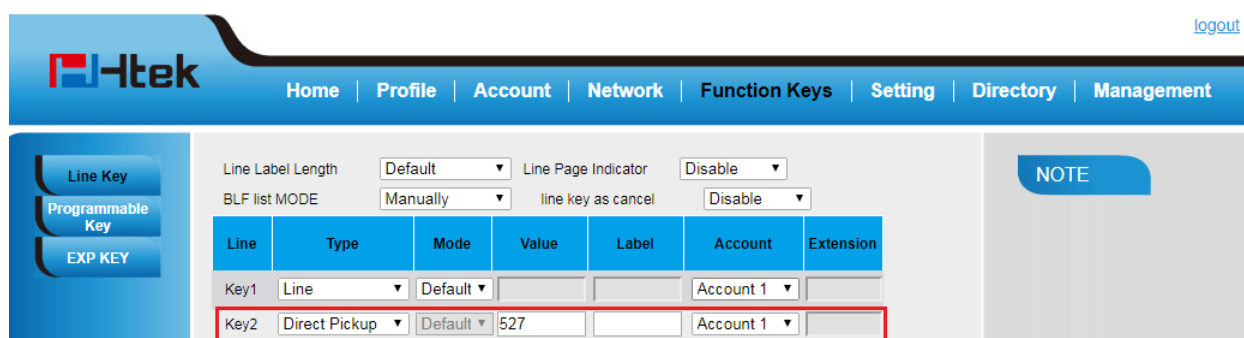
1. Click Function keys → Line Key.
2. Select the wanted Line Key and set as Direct Pickup.
3. Enter the desired phone number in the Value field.
4. Select the Account
5. Click the  button to save the configuration.



Group Pickup

With this feature, you can pick up the specified group that you want incoming calls.

To configure the Group Pickup via Phone interface

1. Press Menu → Features → Function Keys → Line Keys as Function Keys → Line Key2(for example)
2. Press  and  or press Switch soft key to select the Group in the Type field.
3. Enter the group pickup code or the direct pickup code followed the desired phone

number in the Value field.

4. Press and key to select the Account ID.
5. Press or Save soft key to save the configuration

To configure the Group Pick up via Web interface

1. Click Function keys → Line Key.
2. Select the desired Line Key and select Group Pickup in the Type.
3. Enter the group pickup code or the direct pickup code followed the desired phone number in the Value field.
4. Select the Account.
5. Click the to save the configuration.

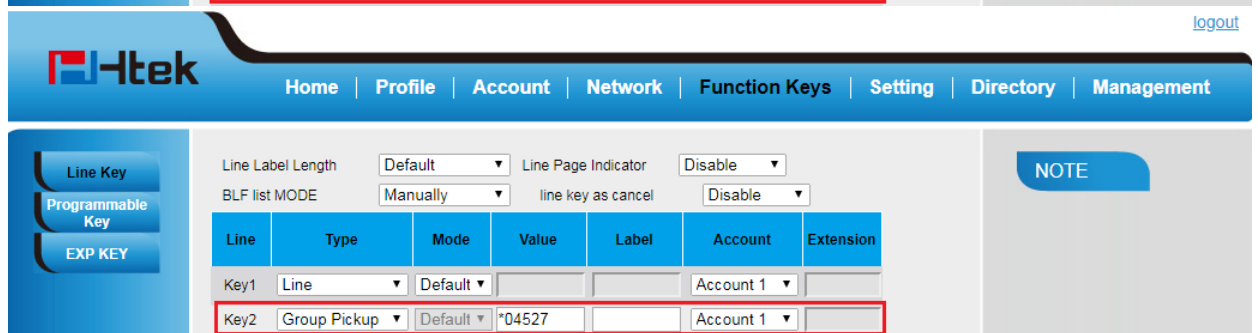
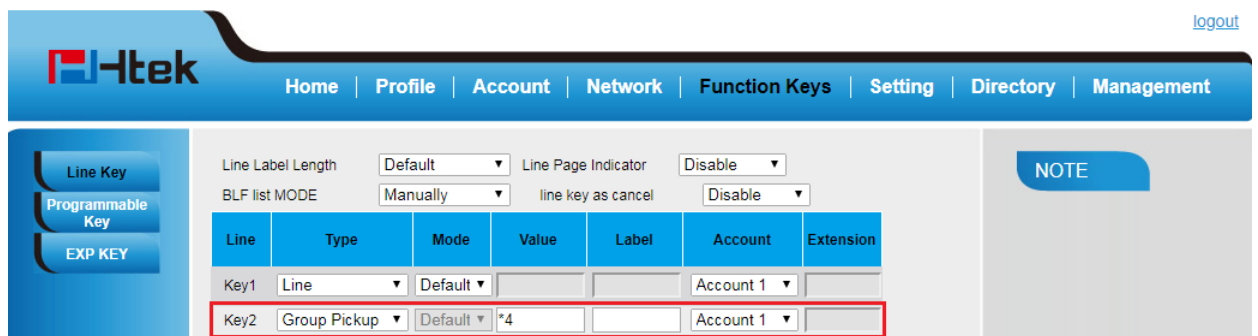



Call Park

With this feature, you can put a call on hold and continue the conversation from another phone.

To configure the Call Park via Phone interface

1. Press Menu →Features →Function Keys →Line Keys as Function Keys → Line Key2(for example)

2. Press  and  or press Switch soft key to select the Call Park type.
3. Select the Account ID.
4. Press  or Save soft key to save the configuration

To configure the Call Park via Web interface

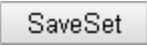
1. Click Function keys → Line Key.
2. Select the desired Line Key and select Call Park in the Type.
3. Enter the call park code in the Value field.
4. Select the Account.
5. Click the  button to save the configuration.

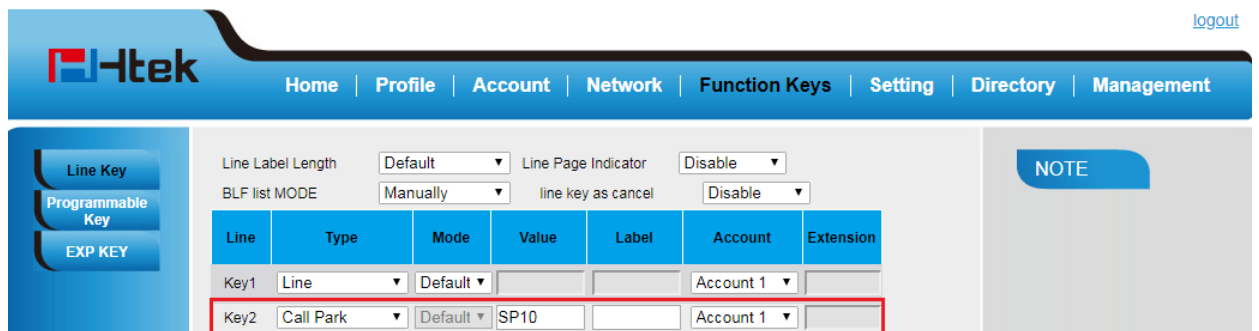



For More information for Call Park, please see: [Call park note](http://www.htek.com/) on www.htek.com/

Intercom

When use the intercom feature, you can quickly get access connect to the configured one.

To configure intercom feature via Phone interface

1. Press Menu →Features →Function Keys →Line Keys as Function Keys → Line Key2(for example)
2. Press  and  or press Switch soft key to select the Intercom in the Type field.
3. Enter the intercom codes followed by desired number in the Value field.

4. Select the Account ID.
5. Press  or Save soft key to save the configuration

Then the selected Line Key will work as intercom.

To configure Intercom feature via Web interface

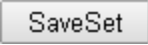
1. Click Function keys → Line Key.
2. Select the wanted Line Key.
3. Enter intercom codes followed by desired number in the Value field.
4. Select the Account
5. Click the  button to save the configuration.

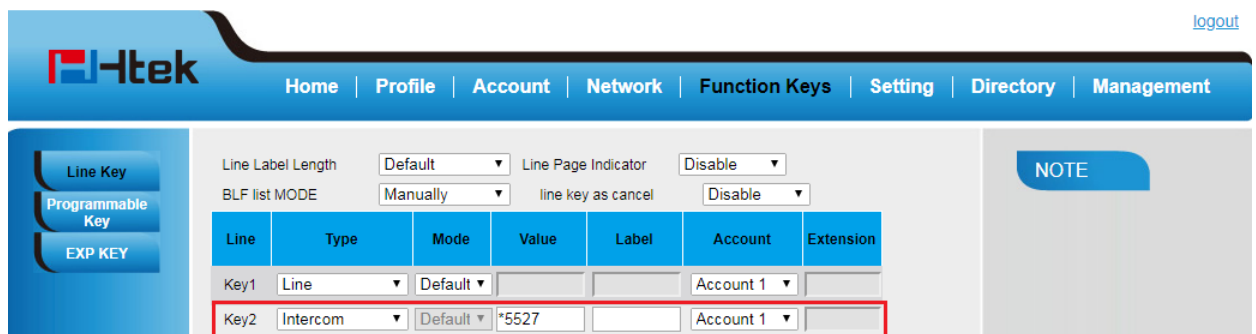

If you want to achieve the intercom feature, you must enable the “Allow Auto Answer By Call-Info”

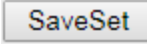
1. Click Profile
2. Select the desired profile from the pull-down list of Profile in the Profile field.
3. Click Advanced
4. Enable the “Allow Auto Answer By Call-Info”
5. Click the  button to save the configuration.

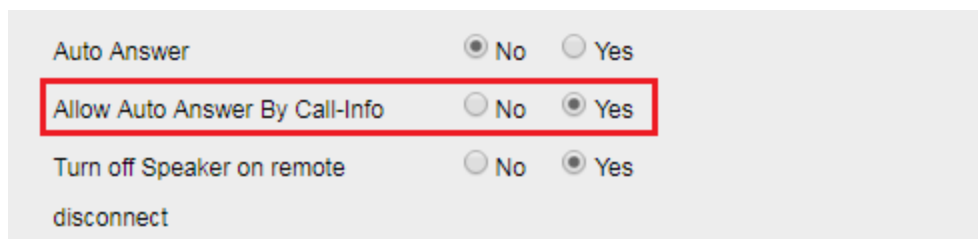

Intercom Barge

If this option is enabled, when there is an active call and an incoming intercom call arrives, the previous call will be put on hold and the intercom call will be answered

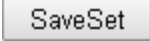
1. Click the Setting → Preference
2. Set On or Off for Intercom Barge.
3. Click  for the setting.

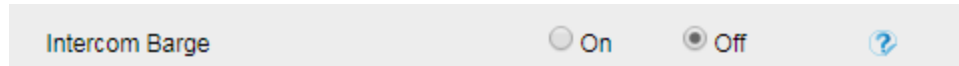

Note:

This feature is not available on all servers. For more information, contact your system administrator.

DTMF

When the key is configured as DTMF key, you are allowed to send out the desired DTMF number during the conversation.

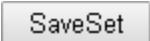

To use this feature, you should sure that the DTMF Tone is on.

To configure the DTMF via Web interface

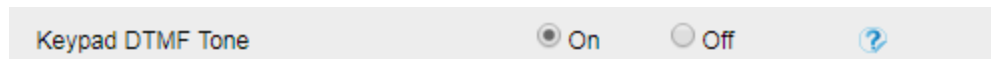
1. Click Setting→ Preference
2. Select On for Keypad DTMF Tone.
3. Click the  button to save the configuration.



To configure the DTMF via Phone interface

1. Press Menu →Features →Function Keys →Line Keys as Function Keys → Line Key2(for example)
2. Press  and  key to select the DTMF in the Type field.
3. Enter the value with the Desired DTMF number
4. Press  or Save soft key to save the configuration

To configure the DTMF via Web interface

1. Click Function keys → Line Key.
2. Select the desired Line Key and select DTMF in the Type.
3. Fill the value with the Desired DTMF number.
4. Click the  button to save the configuration.

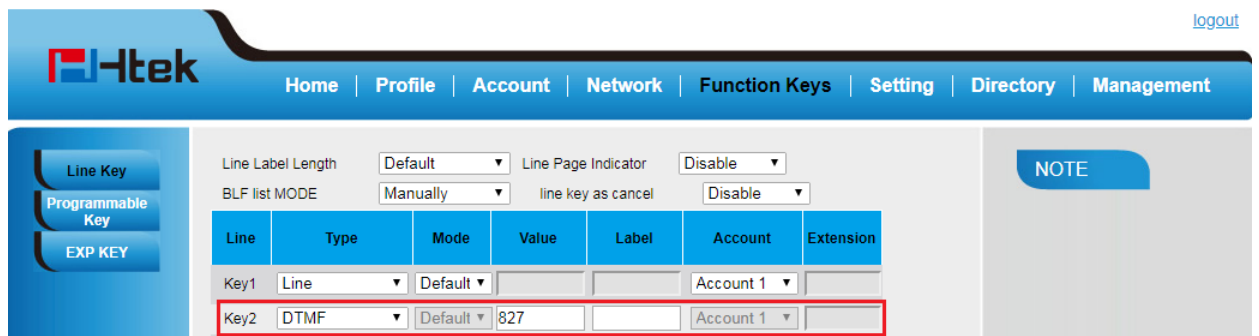



Line Label Length: Default | Line Page Indicator: Disable
 BLF list MODE: Manually | line key as cancel: Disable

Line	Type	Mode	Value	Label	Account	Extension
Key1	Line	Default			Account 1	
Key2	DTMF	Default	827		Account 1	

Prefix

If the key is configured as Prefix key, you can set the number prefix (e.g. Before the number plus 9), then you don't input 9, press the key and 9 will display on the LCD interface.

To configure the Prefix via Phone interface

1. Press Menu → Features → Function Keys → Line Keys as Function Keys → Line Key2(for example)
2. Press  and  key to select the Prefix in the Type field.
3. Enter the value with number that you want to set as prefix
4. Press  or Save soft key to save the configuration

To configure the Prefix via Web interface

1. Click Function keys → Line Key.
2. Select the desired Line Key and select Prefix in the Type.
3. Fill the value.

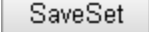
- Click the  button to save the configuration.

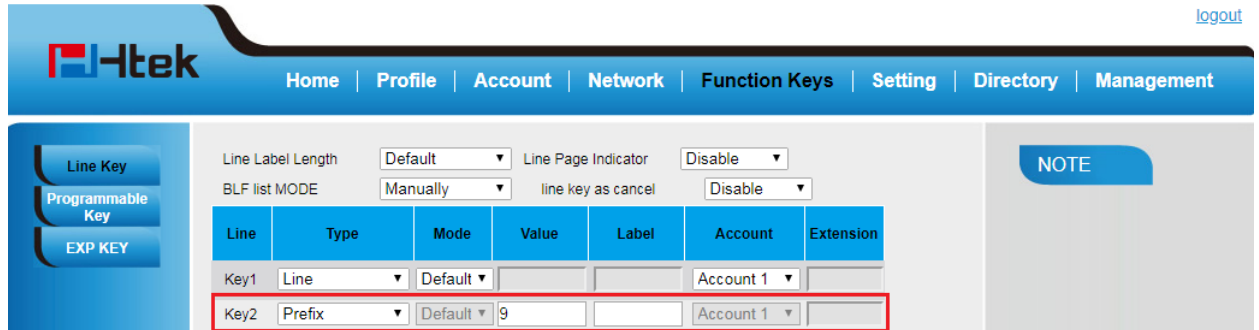

Then when you press this key, the set value is input directly.



Local Group

When use the Local Group feature, press the key and enter the local Contacts interface quickly.

To configure the Local Group via Phone interface

- Press Menu → Features → Function Keys → Line Keys as Function Keys → Line Key2(for example)
- Press  and  key to select the Local Group in the Type field.
- Press  or Save soft key to save the configuration

To configure the Local Group via Web interface

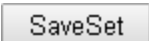
- Click Function keys → Line Key.
- Select the desired Key and select Local Group in the Type.
- Click the  button to save the configuration.

Then you can press the Local Group key to access the pre-defined contact group in the local directory quickly.

Line	Type	Mode	Value	Label	Account	Extension
Key1	Line	Default			Account 1	
Key2	Local Group	Default			Account 1	

XML Group

When use the XML Group feature, press the key and enter the Remote Contacts interface quickly.

To configure the XML Group via Phone interface

1. Press Menu → Features → Function Keys → Line Keys as Function Keys → Line Key2(for example)
2. Press and key to select the XML Group in the Type field.
3. Press and key to select the Account ID.
4. Press or Save soft key to save the configuration

To configure the XML Group via Web interface



1. Click Function keys → Line Key.
2. Select the desired Key and select XML Group in the Type.
3. Click the button to save the configuration.

Line	Type	Mode	Value	Label	Account	Extension
Key1	Line	Default			Account 1	
Key2	XML Group	Default			Account 1	

LDAP

When use the LDAP feature, you can get the LDAP Phonebook directly.

To configure the LDAP via Phone interface

1. Press Menu → Features → Function Keys → Line Keys as Function Keys → Line Key2(for example)
2. Press  and  key to select the LDAP in the Type field.
3. Press  or Save soft key to save the configuration

To configure the LDAP via Web interface

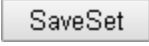
1. Click Function keys → Line Key.
2. Select the desired Key and select LDAP in the Type.
3. Click the  button to save the configuration.

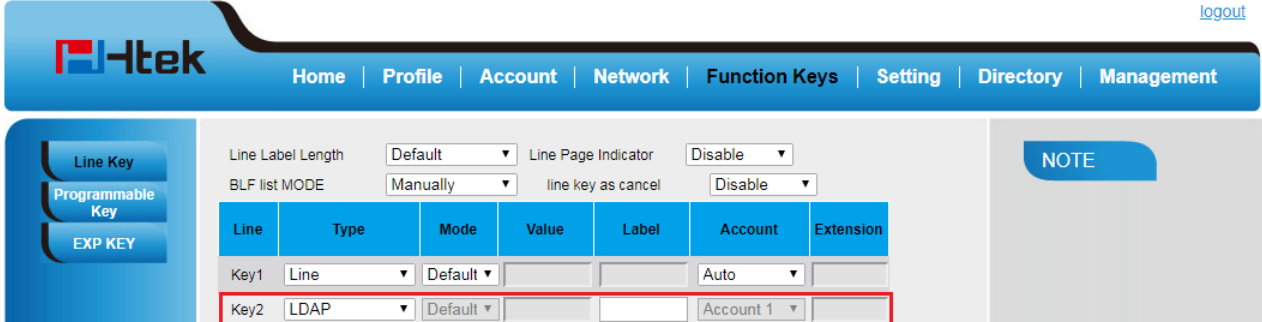



Line	Type	Mode	Value	Label	Account	Extension
Key1	Line	Default			Auto	
Key2	LDAP	Default			Account 1	

XML Browser

You can use this key feature to access the Xml browser quickly. The Xml browser allows you to create custom services which meet your functional requirements on the server. You can customize practical applications, such as weather report, stock information, Google search, etc.

To configure the XML Browser via Phone interface

1. Press Menu →Features →Function Keys →Line Keys as Function Keys → Line Key2(for example)
2. Press  and  key to select the XML Browser in the Type field.
3. Fill the access URL for xml browser
4. Press  or Save soft key to save the configuration

To configure the XML Browser via Web interface

1. Click Function keys → Line Key.
2. Select the desired Key and select Xml Browser in the Type.
3. Fill the access URL for xml browser (e.g.: http://192.168.0.62/xmlbrowser/text.xml)
4. Click  button to save the configuration.

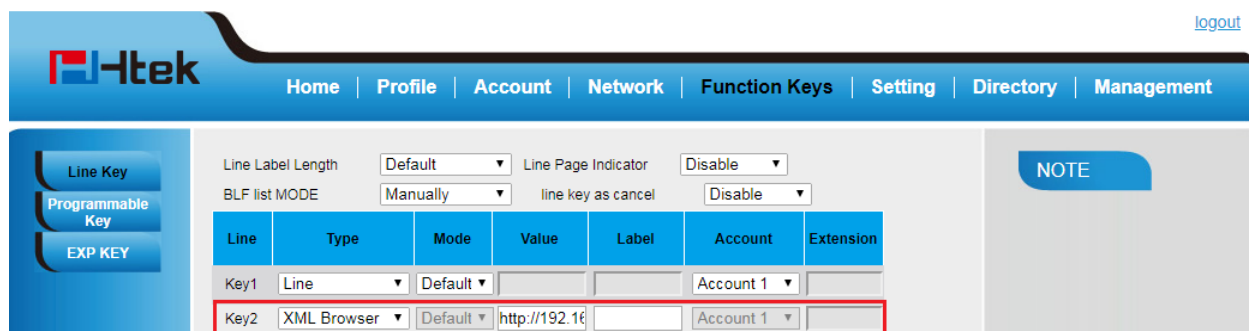



Line	Type	Mode	Value	Label	Account	Extension
Key1	Line	Default			Account 1	
Key2	XML Browser	Default	http://192.168.0.62/xmlbrowser/text.xml		Account 1	

Broadsoft Group

When using the BroadSoft Group feature, by just pressing the key you can enter the Broadsoft Contacts interface quickly.

To configure the Broadsoft Group via Phone interface

1. Press Menu →Features →Function Keys →Line Keys as Function Keys → Line Key2(for example)

2. Press  and  key to select the Broadsoft Group in the Type field.
3. Press  or Save soft key to save the configuration

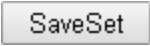

To configure the Broadsoft Group via Web interface

1. Click Function keys → Line Key.
2. Select the desired Key and select Broadsoft Group in the Type.
3. Click the  button to save the configuration.

Conference

The Htek IP Phone supports up to 5-way conference. You are allowed to configure the programmable key to be used as a conference key. This key works same as .

To configure the Conference via Phone interface

1. Press Menu → Features → Function Keys → Line Keys as Function Keys → Line Key2(for example)
2. Press  and  key to select the Conference in the Type field.
3. Press  or Save soft key to save the configuration



To configure Conference via Web interface

1. Click Function keys → Line Key.
2. Select the desired Key and select Conference in the Type.
3. Click the  button to save the configuration.

Forward

If the key is configured as Forward key, press this key under the idle status, the IP phone will turn to the Always Forward interface and you can set the Forward to number, then when there is any call to the number will be forwarded to the set number automatically.

To configure the Forward via Phone interface

1. Press Menu →Features →Function Keys →Line Keys as Function Keys → Line Key2(for example)
2. Press  and  key to select the Forward in the Type field.
3. Enter the Number to forward to.
4. Press  or Save soft key to save the configuration



To configure Forward via Web interface

1. Click Function keys →Line Key.
2. Select the desired Key and select Forward in the Type.
3. Enter the Value with the number you want to forward to.
4. Click the  button to save the configuration.

Transfer

You are able to configure the key as a transfer key to perform the Blind/Attended/Semi-Attended Transfer.

To configure the Transfer via Phone interface

1. Press Menu →Features →Function Keys →Line Keys as Function Keys → Line Key2(for example)
2. Press  and  key to select the Transfer in the Type field.

3. Enter the Number to transfer to
4. Press  or Save soft key to save the configuration

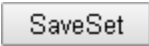

To configure Transfer via Web interface

1. Click Function keys →Line Key.
2. Select the desired Key and select Transfer in the Type.
3. Enter the Value with the number that wanted transfer to
4. Click the  button to save the configuration.

Hold

The key can be configured as a hold key. You can use this key to hold and resume a call during the conversation.

To configure the Hold via Phone interface

1. Press Menu →Features →Function Keys →Line Keys as Function Keys → Line Key2(for example)
2. Press  and  key to select the Hold in the Type field.
3. Press  or Save soft key to save the configuration

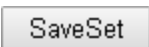

To configure Hold via Web interface

1. Click Function keys →Line Key.
2. Select the desired Key and select Hold in the Type.
3. Click the  button to save the configuration.

Group Listening

With this feature, when you have an active call, you can listen using Handset and Free-speaker, but only can use the handset to speak.

To configure the Group listening via Phone interface

1. Press Menu →Features →Function Keys →Line Keys as Function Keys → Line Key2(for example)
2. Press  and  key to select the Group Listening in the Type field.
3. Press  or Save soft key to save the configuration



To configure Group listening via Web interface

1. Click Function keys →Line Key.
2. Select the desired Key and select Group Listening in the Type.
3. Click the  button to save the configuration.

DND

If the key is configured as DND key, allows you to activate the DND function immediately when you press it and the phone will reject all incoming calls automatically. Press it again to deactivate DND mode.

To configure the DND via Phone interface

1. Press Menu →Features →Function Keys →Line Keys as Function Keys → Line Key2(for example)
2. Press  and  key to select the DND in the Type field.
3. Press  or Save soft key to save the configuration

To configure DND via Web interface

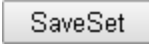
1. Click Function keys →Line Key.
2. Select the desired Key and select DND in the Type.
3. Click the  button to save the configuration.

To enable DND feature

Press the DND soft key when the phone is idle status, and then DND icon shown on the LCD.

To disable DND feature

Press the DND soft key again, and then there is no DND icon on the LCD.

Redial

If the key is configured as Redial key, you can redial the last placed call from the IP Phone.

To configure Redial via Web interface

1. Click Function keys →Line Key
2. Select the desired Key and select Redial in the Type.
3. Enter the Label displayed on LCD.
4. Click the  button to save the configuration.

SMS

Send SMS

To send SMS via web Interface

1. Click Setting→ SMS
2. Select the Account(from which account the SMS sent)
3. Enter the target number

4. Input the content of SMS, and click Send.

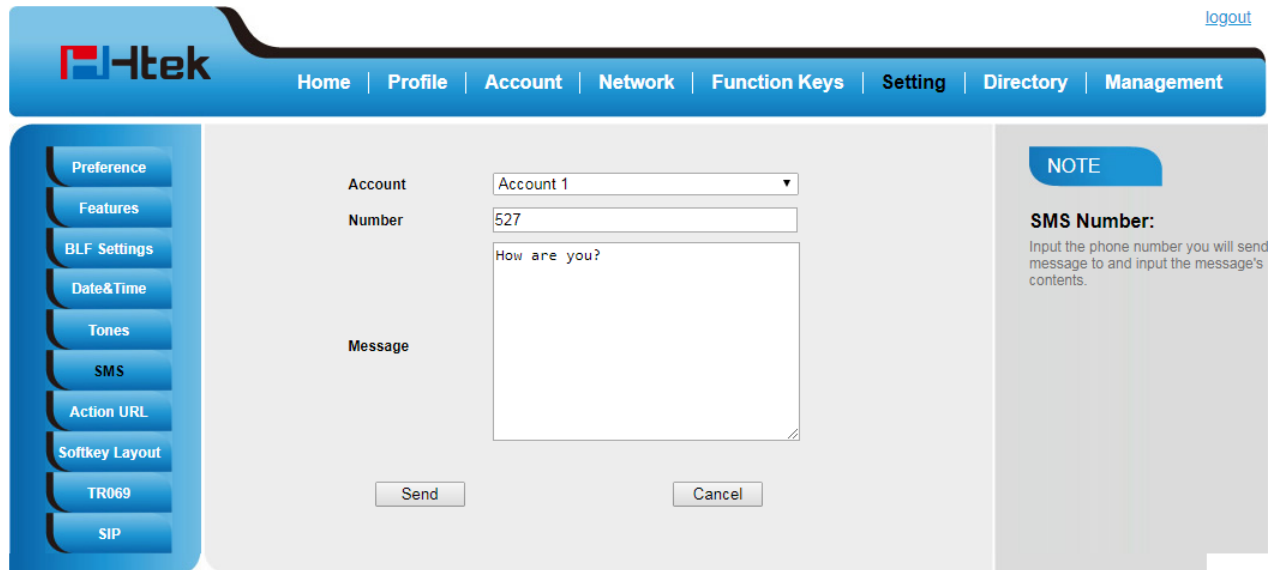



To send SMS via Phone interface :

1. Click Menu→ Messages→ Text Message→ Set SMS
2. Enter the contents in the blank field.
3. Press the Send button
4. Select the account in the From field (from which account the SMS sent)
5. Enter the target number in the To field (to which account the number sent)
6. Press the Send button.

Set SMS Line Key

To configure the SMS via Phone interface

1. Press Menu →Features →Function Keys →Line Keys as Function Keys → Line Key2(for example)
2. Press  and  key to select the SMS in the Type field.
3. Press  or Save soft key to save the configuration

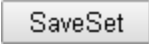

To configure SMS via Web interface

1. Click Function keys →Line Key.
2. Select the desired Key and select SMS in the Type.
3. Click the  button to save the configuration.

Record

With record feature, you can record your calls by pressing the record key .

To configure the record via Phone interface

1. Press Menu →Features →Function Keys →Line Keys as Function Keys → Line Key2(for example)
2. Press  and  or press Switch soft key to select the Record in the Type field.
3. Press  or Save soft key to save the configuration

To configure the record via Web interface

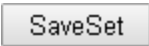
1. Click Function keys → Line Key.
2. Select the desired Line Key and select Record in the Type.
3. Click the  button to save the configuration.

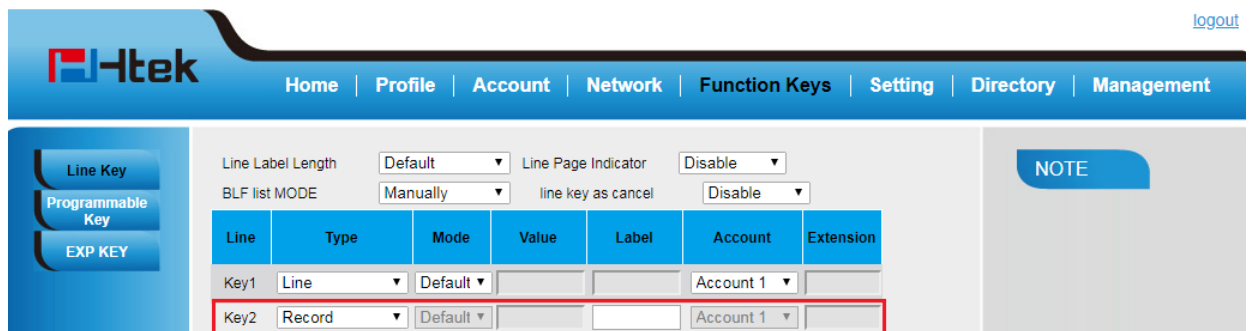

The screenshot shows the Htek web interface for configuring function keys. The navigation bar includes Home, Profile, Account, Network, Function Keys, Setting, Directory, and Management. The 'Function Keys' section is active, showing a table for configuring keys. The 'Key2' row is highlighted with a red box, indicating it is the selected key. The 'Type' field for Key2 is set to 'Record' and the 'Account' field is set to 'Account 1'. Other settings include Line Label Length (Default), Line Page Indicator (Disable), BLF list MODE (Manually), and line key as cancel (Disable).

Line	Type	Mode	Value	Label	Account	Extension
Key1	Line	Default			Account 1	
Key2	Record	Default			Account 1	



Note:

Please contact the system administrator whether support this feature or not.

URL Record

The phone sends HTTP URL request to trigger a recording. Contact your system administrator for the predefined URL.

To configure the URL record via Phone interface

1. Press Menu →Features →Function Keys→ Line Keys as Function Keys → Line Key2(for example)
2. Press  and  key to select the URL Record in the Type field.
3. Press  or Save soft key to save the configuration



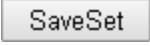

To configure the record via Web interface

1. Click Function keys → Line Key.
2. Select the desired Line Key and select URL Record in the Type.
3. Fill the Value.
4. Click the  button to save the configuration.

Paging

With this feature, you can call a paging group directly.

To configure the paging via Phone interface

1. Press Menu →Features →Function Keys →Line Keys as Function Keys → Line Key2(for example)
2. Press  and  or press Switch soft key to select the Paging in the Type field.
3. Enter the paging code followed the number.
4. Press  and  key to select the Account ID.
5. Press  or Save soft key to save the configuration

To configure the Paging via Web interface

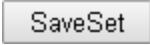
1. Click Function keys → Line Key.
2. Select the desired Line Key and select Paging in the Type.
3. Enter the paging code followed the number.
4. Select the Account.
5. Click the  button to save the configuration.

Shared Line

Htek IP Phone supports “Share Call Appearance” by Broadsoft and XCast standard. This feature allows members of the SCA group to shared SIP lines and provides status monitoring (idle, active, progressing, hold) of the shared line. When there is an incoming call designated for the SCA group, all of the members of the group will be notified of an incoming call and will be able to answer the call from the phone with the SCA extension registered in the group.





All the users that belong to the same SCA group will be notified by visual indicator when a user seizes the line and places an outgoing call, and all the users of this group will not be able to seize the line until the line goes back to an idle state or when the call is placed on hold (with the exception of when multiple call appearances are enabled on the server side).

In the middle of the conversation, there are two types of hold: Public Hold and Private Hold. When a member of the group places the call on public hold, the other users of the SCA group will be notified of this by the red-flashing button and they will be able to resume the call from their phone by pressing the line button. However, if this call is placed on private-hold, no other member of the SCA group will be able to resume that call.

To enable share call appearance, the user would need to register the share line account on the phone. In addition, they would need to navigate to “Account” -> “Advanced” on the webpage and set the line to “Share Line” and “SIP Server Type”, and configure the line key or Line Key as “line” type with the desired account on webpage or LCD. If the user requires more share call appearances, the user can configure multiple line keys (Function keys->Line key) to be “line” type associated with the account.

This feature is very useful in the boss and secretary scenario. For example, the secretary can share the boss' extension number on her phone. When there is an incoming call to the extension number of the boss, both the phones of the boss and the secretary will ring simultaneously. Either the boss or the secretary can answer the call. Calls on share line can be placed on hold or barged in.

To configure the line key as line via Phone interface

1. Press Menu → Features → Function Keys → Line Keys as Function Keys → Line Key2(for example)
2. Press  and  key to select the Line in the Type field.
3. Press  and  key to select the Account ID.
4. Enter the Label
5. Enter the Value
6. Press  or Save soft key to save the configuration

To configure the line key as line via Web interface

1. Click Function keys → Line Key.
2. Select the desired Line Key and select Line in the Type.
3. Enter the Value.
4. Enter the Label.
5. Select the Account
6. Click the  button to save the configuration and then restart.



Note:

This feature is not available on all servers. For more information, contact your system administrator.

Public Hold

The key can be configured as a public hold key. During a conversation, all members belonging to that particular SLA group can use this key to hold or resume a call.

To configure the Public hold via Phone interface

1. Press Menu →Features →Function Keys →Line Keys as Function Keys → Line Key2(for example)
2. Press  and  key to select the Public Hold in the Type field.
3. Press  or Save soft key to save the configuration

To configure public hold via Web interface

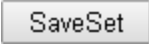
1. Click Function keys →Line Key.
2. Select the desired Key and select Public Hold in the Type.
3. Click the  button to save the configuration.

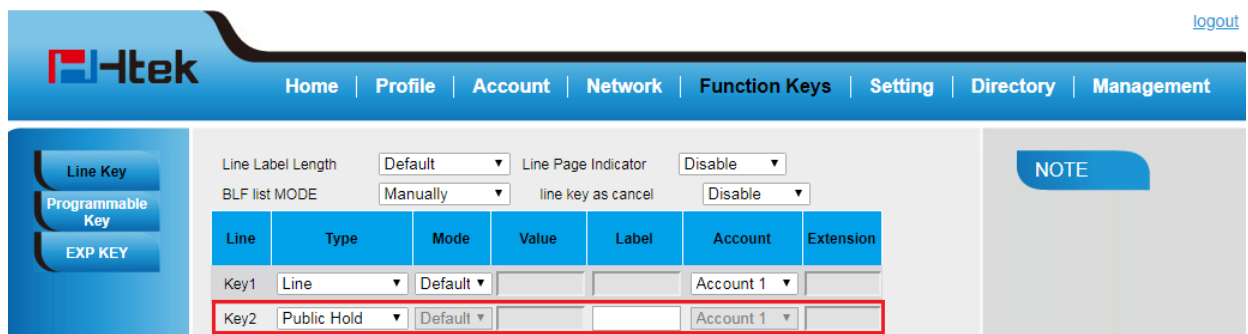



The screenshot shows the Htek web interface for configuring function keys. The navigation bar includes Home, Profile, Account, Network, Function Keys, Setting, Directory, and Management. The 'Function Keys' section is active, showing a table of keys. The 'Key2' row is highlighted with a red box, indicating it is selected. The 'Type' field for Key2 is set to 'Public Hold' and the 'Account' field is set to 'Account 1'. Other settings like 'Line Label Length', 'Line Page Indicator', and 'BLF list MODE' are visible at the top of the configuration area.

Line	Type	Mode	Value	Label	Account	Extension
Key1	Line	Default			Account 1	
Key2	Public Hold	Default			Account 1	

Private Hold

The key can be configured as a private hold key. During a conversation, all members belonging to that particular SLA group can use this key to hold the call, but only the initiator can resume the call.

To configure the Private hold via Phone interface

1. Press Menu →Features →Function Keys →Line Keys as Function Keys → Line Key2(for example)
2. Press  and  key to select the Private Hold in the Type field.
3. Press  or Save soft key to save the configuration

To configure private hold via Web interface

1. Click Function keys →Line Key.

2. Select the desired Key and select Private Hold in the Type.
3. Click the  button to save the configuration.

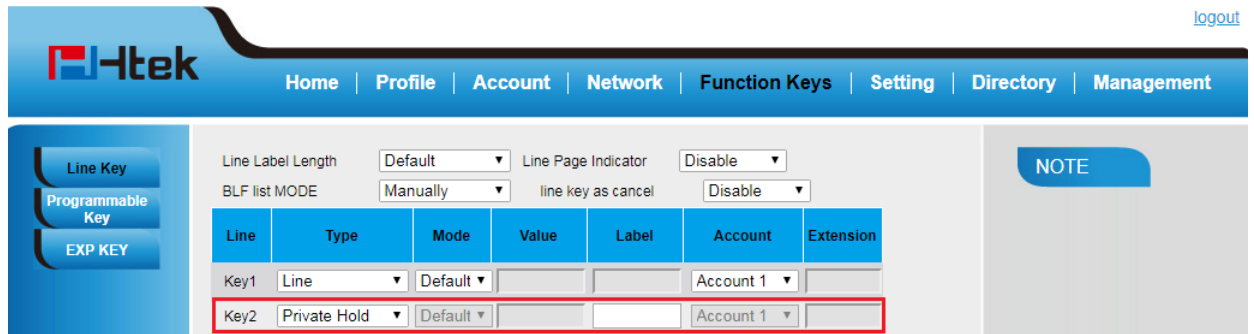





Hot Desking

Hot Desking originates from the definition of being the temporary physical occupant of a work station or surface by a particular employee. A primary motivation for Hot Desking is cost reduction. This feature is regularly used in places where all employees are not in the office at the same time, or not in the office for a very long time, which means their personal offices are often vacant, consuming valuable space and resources.

You can use Hot Desking on the IP phone to logout the existing accounts and then log in a new account, which allows many users to share the phone resource in different times. To use this feature, first you need to configure a Hot Desking key in the advance settings. This feature is supported on the version 1.0.3.82 or later

To configure the hot desking via Phone interface

1. Press Menu → Features → Function Keys → Line Keys as Function Keys → Line Key2(for example)
2. Press  and  or press  key to select the Hot Desking in the Type field.
3. Enter the display name in the Label field.
4. Press  or Save soft key to save the configuration

To configure the hot desking via Web interface:

1. Click Function keys → Line Key.

2. Select the desired Key and select Hot Desking in the Type.
3. Select the desired account from the pull-down list of Account field.
4. Click the  button to save the configuration.

To use the Hot desking feature on the user interface:

1. Press the Hot Desking key when the IP Phone is idle.
2. Enter the Extension number and password



3. Click Save soft key

You can see the account information which has changed.



Note:

This feature is not available on all servers. For more information, contact your system administrator.

ACD

ACD feature is often used in offices for customer service, such as call center. The ACD system handles large volumes of incoming calls from callers who have no need to talk to a specific person but who require assistance from any of the different personnel at the earliest point. The ACD feature on the Htek IP Phone allows the ACD system to distribute calls from large volumes of incoming calls to the registered IP phone users. To use this feature, first you should configure an ACD key in the advance settings.

To configure the ACD via Phone interface

1. Press Menu →Features →Function Keys →Line Keys as Function Keys → Line Key2(for example)
2. Press  and  or press  key to select the ACD in the Type field.
3. Enter the label in the Label field.
4. Select the desired account in the Account ID field.

5. Press  or Save soft key to save the configuration

To configure the ACD via Web interface :

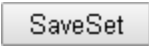
1. Click Function keys →Line Key.
2. Select the desired Key and select ACD in the Type.
3. Enter the label in the Label field.
4. Select the desired account from the pull-down list of Account field.
5. Click the  button to save the configuration.





Note:

This feature is not available on all servers. For more information, contact your system administrator.

Zero Touch

You can use this key feature to configure auto provision and network parameters quickly. This feature is supported on the version 1.0.3.82 or later

To configure the zero touch via Phone interface

1. Press Menu →Features →Function Keys →Line Keys as Function Keys → Line Key2(for example)
2. Press  and  or press  key to select the Zero Touch in the Type field.
3. Press  or Save soft key to save the configuration

To configure the zero touch via Web interface :

1. Click Function keys →Line Key.
2. Select the desired Key and select Zero Touch in the Type.
3. Click the  button to save the configuration.

To use the zero touch feature on the user interface :

1. Press the Zero Touch key when the IP Phone is idle.
2. Press the OK soft key and the IP Phone will enter the WAN Port interface; you can change the WAN Type by pressing the Navigation keys.
3. Press the Next soft key to enter Network interface, then you can configure some information.
4. Press the Next soft key again, you can configure auto provision information.
5. When you finish the setting, you can press the OK to accept the changes.

Note:



This feature is not available on all servers. For more information, contact your system administrator.

Multicast Paging

You can use multicast paging to quickly and easily forward out time sensitive announcements to people within the multicast group. You can configure a multicast paging key or a paging list key on the phone, which allows you to send a Real Time Transport Protocol (RTP) stream to the pre-configured multicast address(es) without involving SIP signaling. You can configure the phone to receive an RTP stream from pre-configured multicast listening address(es) without involving SIP signaling. You can specify up to 10 multicast listening addresses.

Sending RTP Stream

To configure a multicast paging key via Phone interface

1. Press Menu → Features → line or Line Key → Line Key2 (e.g.)
2. Press  and  or Switch key to select the Multicast Paging in the Type field.
3. Enter the multicast IP address and port number (e.g., 224.5.6.20:2000) in the Value field.
The valid multicast IP addresses range from 224.0.0.0 to 239.255.255.255.
4. Press  or Save soft key to save the configuration

To configure a multicast paging key via Web interface

1. Function keys->Line key:
2. Select the desired Key and select Multicast Paging in the Type.
3. Enter the multicast IP address and port number (e.g., 224.5.6.20:2000) in the Value field.
The valid multicast IP addresses range from 224.0.0.0 to 239.255.255.255.
4. Click the  button to save the configuration.

Sending RTP Stream:

Press the multicast paging key when the phone is idle.

The phone sends RTP to a preconfigured multicast address (IP: Port). Any phone in the local network then listens to the RTP on the preconfigured multicast address (IP:Port). For both sending and receiving of the multicast RTP, there is no SIP signaling involved. The multicast paging key LED illuminates solid green.

Receiving RTP Stream

You can configure the phone to receive a Real Time Transport Protocol (RTP) stream from the pre-configured multicast address(es) without involving SIP signaling. You can specify up to 10 multicast addresses that the phone listens to on the network.

How the phone handles incoming multicast paging calls depends on Paging Barge and Paging Priority Active parameters configured via web user interface.

Paging Barge

The paging barge parameter defines the priority of the voice call in progress. If the priority of an incoming multicast paging call is lower than that of the active call, it will be ignored automatically. If Disabled is selected from the pull-down list of Paging Barge, the voice call in progress will take precedence over all incoming multicast paging calls.

Valid values in the Paging Barge field:

- 1 to 10: Define the priority of the active call, 1 with the highest priority, 10 with the lowest.
- Disabled: The voice call in progress will take precedence over all incoming paging calls.

Paging Priority Active

The paging priority active parameter decides how the phone handles incoming multicast paging calls when there is already a multicast paging call on the phone. If enabled, the phone will ignore incoming multicast paging calls with lower priorities, otherwise, the phone will answer incoming multicast paging calls automatically and place the previous multicast paging call on hold. If disabled, the phone will automatically ignore all incoming multicast paging calls.

Multicast Codec:

You can only configure the codec by Web interface.

To configure multicast codec key via Web interface

1. Click Directory ->Multicast Paging:
2. Select the desired codec from the pull-down list of Multicast Codec
3. Click the button to save the configuration.

To configure multicast listening addresses via Web interface:

1. Click Directory->Multicast Paging.
2. Select the desired value from the pull-down list of Paging Barge.
3. Select the desired value from the pull-down list of Paging Priority Active.
4. Enter the multicast IP address(es) and port number (e.g., 224.5.6.20:2000) which the phone listens to for incoming RTP multicast in the Listening Address field.
5. Enter the label in the Label field.
6. Click button to save the configuration.

[logout](#)

Htek Home | Profile | Account | Network | Function Keys | Setting | Directory | Management

Directory
Remote Phone Book
Call History
LDAP
Network Directory
MultiCast Paging

Paging Barge: 10
Paging Priority Active: Enable
Multicast Codec: PCMU

Index	Listening Address	Label	Multi Priority
IP Address 1	224.5.6.20:2000	test1	1
IP Address 2			2
IP Address 3			3
IP Address 4			4
IP Address 5			5
IP Address 6			6
IP Address 7			7
IP Address 8			8
IP Address 9			9
IP Address 10			10

NOTE

Note:
The priorities of listening to multicasting addresses can be predefined: 1 being the highest priority, 10 with the lowest in priority order. Both the multicast paging sender and receiver's phones play a warning tone when establishing a multicast paging call. Listening to Multicasting addresses can be configurable via Web interface only.

Upgrade

Factory Reset

To set Factory Reset by Phone interface

1. Press Menu → Settings → Advanced Setting(default password: admin) → Phone Setting → Factory Reset
2. Press OK soft key in the warning page.

To Reset to Factory via Web interface

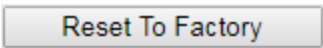
1. Click Management → Upgrade
2. Click  and then confirm the setting.

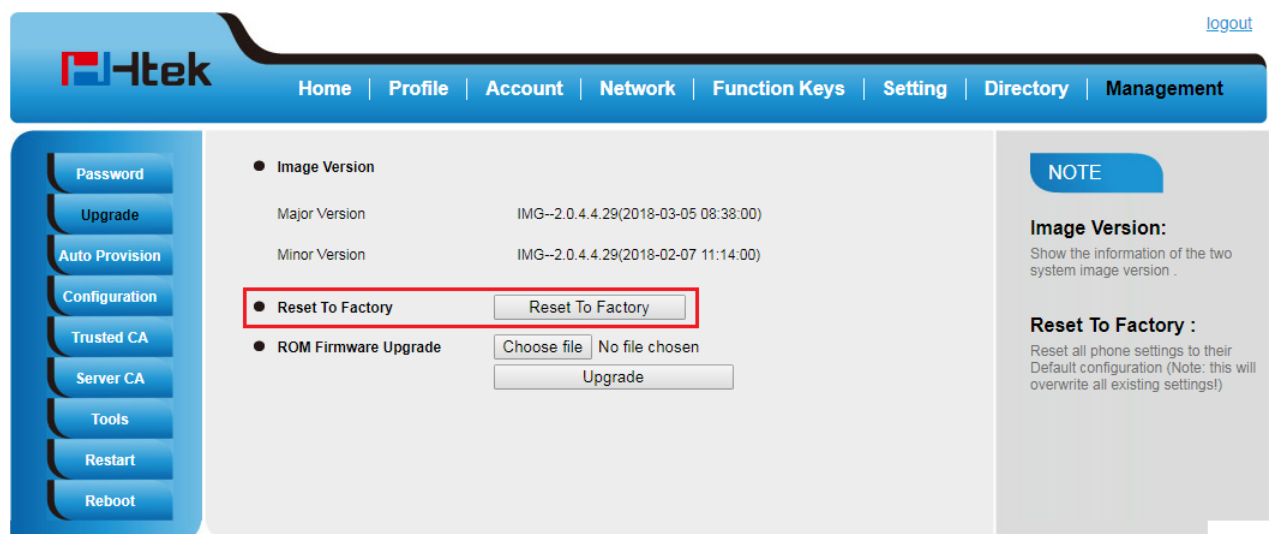

The screenshot shows the Hitek web interface. At the top right, there is a [logout](#) link. The navigation bar includes: Home | Profile | Account | Network | Function Keys | Setting | Directory | Management. A left sidebar contains menu items: Password, Upgrade, Auto Provision, Configuration, Trusted CA, Server CA, Tools, Restart, and Reboot. The main content area shows 'Image Version' information: Major Version (IMG--2.0.4.4.29(2018-03-05 08:38:00)) and Minor Version (IMG--2.0.4.4.29(2018-02-07 11:14:00)). Below this, the 'Reset To Factory' option is selected and highlighted with a red box, with a corresponding 'Reset To Factory' button. The 'ROM Firmware Upgrade' section has a 'Choose file' button (showing 'No file chosen') and an 'Upgrade' button. A 'NOTE' box on the right states: 'Image Version: Show the information of the two system image version . Reset To Factory : Reset all phone settings to their Default configuration (Note: this will overwrite all existing settings!)

Pcap Feature

To use pcap via Web interface :

1. Click Management→ Tools
2. Click Start and then operation the phone
3. When finish the operation, click Stop and then click Export.

4. Then you'll get the Pacp captures.

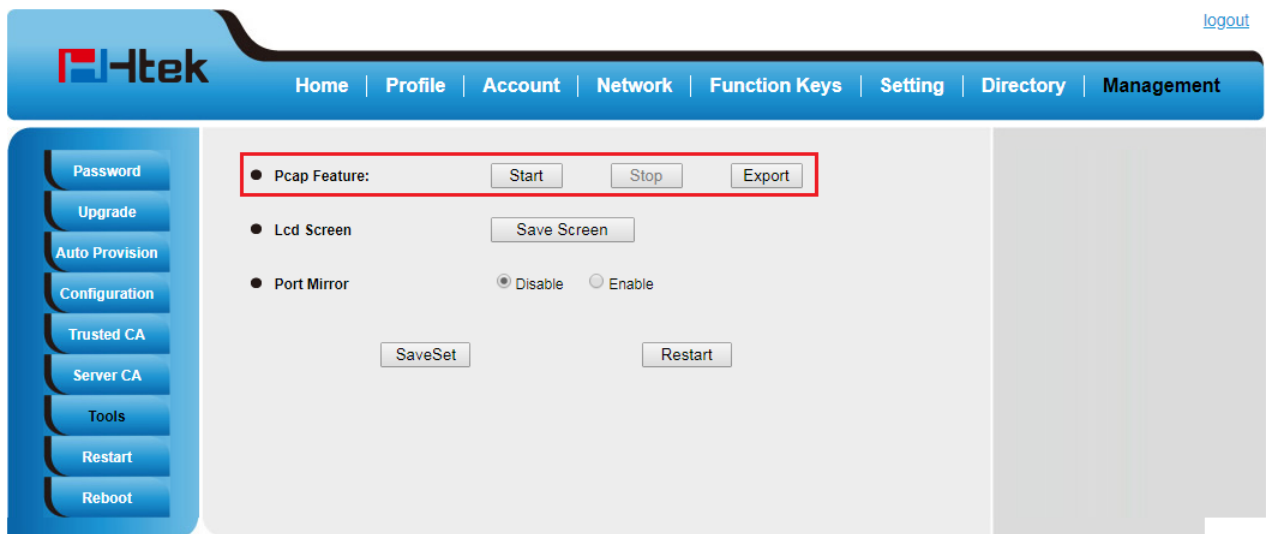

System Log

To download system log via Web interface :

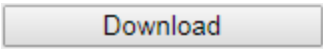
1. Click Management → Configuration
2. Click  of the system Log

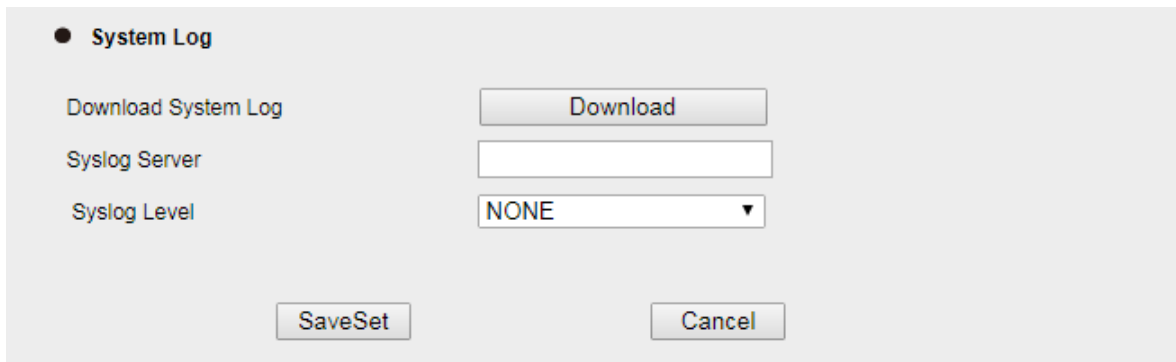

3. Then you'll get a txt file: syslog.tgz.

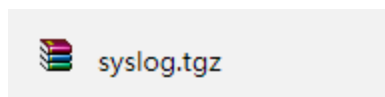

Upgrade

To upgrade via HTTP, the "Management" → "auto provision" → "Firmware Upgrade" → "Upgrade Mode" field needs to be set to HTTP, respectively. "Firmware Server Path"

needs to be set to a valid URL of a HTTP server, server name can be in either FQDN or IP address format. Here are examples of some valid URL.

- e.g. firmware.mycompany.com:5688/Htek
- e.g. www.mycompany.com:5688/fm/Htek
- e.g. 218.2.83.110

Instructions for firmware upgrade via HTTP:

- (1) End users can choose to download the free HTTP server from <http://httpd.apache.org/> or use Microsoft IIS web server. Then setup HTTP server.
- (2) Unzip the firmware file and put all of them under the *root/fm* directory of the HTTP server.
- (3) Visiting “<http://192.168.0.254/fm/fw912G.rom> on localhost by browser” to verify the HTTP Server. If visiting “<http://192.168.0.254/fm/fw912G.rom> on another computer and it not prompted to download fw926.rom file on this computer, please check if the firewall is on or off (Suggest you turn off the firewall).

To configure the server path via Web interface:

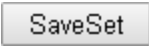
1. Click Management→ Auto provision:
2. Select the upgrade mode in the Upgrade Mode field
3. Enter the Firmware Server Path and Config Server Path (192.168.0.254 is HTTP server).
4. Enter the HTTP server’s username and password (optional).
5. Click the  button to save the configuration.
6. Restart the UC903, IP Phone will restart and auto-get firmware files from HTTP server.

NOTES:

- Htek recommends end-user use the Htek HTTP server. For large companies, we recommend to maintain their own TFTP/HTTP/FTP/HTTPS server for upgrade and provisioning procedures.
- Once a “Firmware Server Path” is set, user needs to update the settings and restart the IP Phone. If the configured firmware server is found and a new code image is available, the UC912G will attempt to retrieve the new image files by downloading them into the UC912G’s SDRAM. During this stage, the UC912G’s LEDs will blink fastly until the checking/downloading process is completed. Upon verification of checksum, the new code image will then be saved into the Flash. If TFTP/HTTP/FTP/HTTPS fails for any reason (e.g. TFTP/HTTP/FTP/HTTPS server is not responding, there are no code image files available for upgrade, or checksum test fails, etc), the UC912G will stop the TFTP/HTTP/FTP/HTTPS process and simply boot using the existing code image in the flash.
- Firmware upgrade may take as long as 3 to 8 minutes over Internet, or just 1 minutes if it is performed on a LAN. It is recommended to conduct firmware upgrade in a controlled LAN environment if possible. For users who do not have a local firmware upgrade server.
- Htek’s latest firmware is available at <http://www.htek.com> → Support→ Document & Firmware.
- Oversea users are strongly recommended to download the binary files and upgrade firmware locally in a controlled LAN environment.

To upgrade manually via the Web configuration interface

1. Click Management → Upgrade
2. Click Management → Upgrade
3. Click Choose file or the blank.

4. Select the firmware (fw912G.rom)and then click

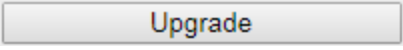

NOTE

Image Version:
Show the information of the two system image version .

Reset To Factory :
Reset all phone settings to their Default configuration (Note: this will overwrite all existing settings!)

Configuration File

To download configuration file:

1. Click Management → Configuration →Configure File
2. Click the or , then you can get a file: cfg.bin or cfg.xml

Configure File

Download Device Xml Configuration

Restore Xml Configuration No file chosen

Download Device Bin Configuration

Restore Bin Configuration No file chosen

Download User Bin Configuration

Delete User Configuration

To Restore a configuration file:

1. Click Management → Configuration →Configure File
2. Select the xxx.bin or xxx.xml file, and then Click the

or , then IP Phone will reboot.

● Configure File

Download Device Xml Configuration	<input type="button" value="Download Xml File"/>
Restore Xml Configuration	<input type="button" value="Choose file"/> No file chosen <input style="border: 2px solid red;" type="button" value="Restore Xml Configuration"/>
Download Device Bin Configuration	<input type="button" value="Download Bin File"/>
Restore Bin Configuration	<input type="button" value="Choose file"/> No file chosen <input style="border: 2px solid red;" type="button" value="Restore Bin Configuration"/>
Download User Bin Configuration	<input type="button" value="Download User Bin File"/>
Delete User Configuration	<input type="button" value="Delete User File"/>

Troubleshooting

Why is the phone LCD screen blank?

- Ensure your phone is properly plugged into a functional AC outlet.
- Ensure that the phone isn't plugged into a plug controlled by a switch that is off.
- If the phone is plugged into a power strip, try plugging it directly into a wall outlet instead.
- If your phone is powered from PoE, ensure you use a PoE compliant switch or hub, or contact your system administrator for more information.
- Check if the power LED is on to ensure that the phone is powered on.

Why does the phone display "Network Unavailable"?

To resolve:

- Ensure that the Ethernet cable is plugged into the Internet port on the phone and the Ethernet cable is not loose.
- Ensure that the switch or hub in your network is functioning well.
- If the problem still persists, contact your system administrator for more information.

Why can't I get a dial tone?

To resolve:

- Check for any loose connections and that the phone has been installed properly. For the Installation instructions, refer to the phone installation section.
- Check whether dial tone is present on one of the audio modes.
- Switch between the Handset, Headset (if you have) or Hands-Free Speakerphone to check whether dial tone is present for one of the audio modes.
- If the dial tone exists on another audio mode, connect a different handset or headset to isolate the problem.

Where to set the tone?

You can set the tone on Web interface:

- Click Setting→ Tones
- Define the dial tone, ringing, busy tone...
- For the tones, you can check with your system administrator.
- For more Click [Tone Notes](#).

[logout](#)

Home | Profile | Account | Network | Function Keys | Setting | Directory | Management

Preference
Features
BLF Settings
Date&Time
Tones
SMS
Action URL
Softkey Layout
TR069
SIP

Select Country: Custom

Dial Tone: f1=350@-13,f2=440@-13,c=0/0;

Ringback Tone: f1=440@-19,f2=480@-19,c=2000/4000;

Busy Tone: f1=480@-24,f2=620@-24,c=500/500;

Reorder Tone: f1=480@-24,f2=620@-24,c=250/250;

Confirmation Tone: f1=350@-11,f2=440@-11,c=100/100-100/100-100/100;

Call Waiting Tone: f1=440@-13,c=300/10000-300/10000-0/0;

Syntax: f1=freq@vol, f2=freq@vol, c=on1/off1-on2/off2-on3/off3; [...]
Note: freq: 0 - 4000Hz; vol: -30 - 0dBm

NOTE
Select Country:
Select your country to generate the standard call tones. Or select Custom to customize the call tones.

SaveSet Cancel

How to download XML Configuration?

- Click Management→ Configuration→

Download Xml File

How to Import Trusted CA certificate?

- Click Management → Trusted CA

The screenshot shows the Htek web interface. The top navigation bar includes Home, Profile, Account, Network, Function Keys, Setting, Directory, and Management. A sidebar on the left contains menu items: Password, Upgrade, Auto Provision, Configuration, Trusted CA (selected), Server CA, Tools, Restart, and Reboot. The main content area displays a table with columns: Index, Issued TO, Issued By, Expiration, and Delete. The table contains 10 rows, each with a delete checkbox. Below the table is a 'Delete' button. The configuration section includes: 'Import Trusted Certificate Files' with a 'Choose file' button and 'No file chosen' text; 'Import Trusted Certificates' button; 'Only Accept Trusted Certificates' with radio buttons for 'On' and 'Off' (selected); 'Common Name Validation' with radio buttons for 'On' and 'Off' (selected); 'Trusted Certificates' with radio buttons for 'Default Certificates' (selected), 'Custom Certificates', and 'All Certificates'. 'SaveSet' and 'Cancel' buttons are at the bottom. A 'NOTE' box on the right states: 'Trusted CA: you can import TLS certificate file here.' A 'logout' link is in the top right corner.

How to Import Server CA certificate?

- Click Management → Server CA

The screenshot shows the Htek web interface. The top navigation bar includes Home, Profile, Account, Network, Function Keys, Setting, Directory, and Management. A sidebar on the left contains menu items: Password, Upgrade, Auto Provision, Configuration, Trusted CA, Server CA (selected), Tools, Restart, and Reboot. The main content area displays a table with columns: Issued TO, Issued By, Expiration, and Delete. The table is empty. Below the table is a 'Delete' button. The configuration section includes: 'Import Server Certificate Files' with a 'Choose file' button and 'No file chosen' text; 'Import Server Certificates' button; 'Device Certificates' with radio buttons for 'Default Certificates' (selected) and 'Custom Certificates'. 'SaveSet' and 'Cancel' buttons are at the bottom. A 'NOTE' box on the right states: 'Trusted CA: you can import TLS certificate file here.' A 'logout' link is in the top right corner.

How to use Vlan?

- For Vlan information, please click [VLAN Note](#)

How to use LLDP?

- For LLDP information, please click [VLAN Note](#)
- VLAN Notes including:
 1. Voice VLAN
 2. Major Benefits of Using VLANs
 3. VLAN discovery method on Htek ip phones
 4. LLDP Feature on Htek IP Phones
 5. Supported TLVS of IP Phones
 6. Configuring LLDP Feature
 7. DHCP VLAN
 8. Open the DHCP VLAN on the Htek IP Phones
 9. VLAN under Bridge Mode
 10. VLAN under NAT Mode

How to Set LCD and Web GUI?

- Click [LCD and Web GUI custom Guide](#)

How to Upgrade via FTP?

- Click [How to Upgrade Note](#)

How to make Ringtone?

- Click [How to Make Ringtone](#)

How to use Open VPN?

- Click [Open VPN note](#)

Provisioning Guide on Free PBX

- Click [Set Auto Provision on FreePBX](#)

Redundancy Server

- Click [Redundancy Server](#)

How to Use Auto Provision Phonebook?

- Click [About AP Phonebook](#)

All Documents

- Click [Documents Guide](#), you can get all tech files.