

Mitel 6867i SIP Phone

58015402 REV00

RELEASE 5.0.0 USER GUIDE

NOTICE

The information contained in this document is believed to be accurate in all respects but is not warranted by Mitel Networks Corporation (MITEL®). The information is subject to change without notice and should not be construed in any way as a commitment by Mitel or any of its affiliates or subsidiaries. Mitel and its affiliates and subsidiaries assume no responsibility for any errors or omissions in this document. Revisions of this document or new editions of it may be issued to incorporate such changes.

No part of this document can be reproduced or transmitted in any form or by any means - electronic or mechanical - for any purpose without written permission from Mitel Networks Corporation. Send an email to iplegal@mitel.com for more details.

Trademarks

The trademarks, service marks, logos and graphics (collectively "Trademarks") appearing on Mitel's Internet sites or in its publications are registered and unregistered trademarks of Mitel Networks Corporation (MNC) or its subsidiaries (collectively "Mitel") or their respective owners. Use of the Trademarks is prohibited without the express consent from Mitel. Please contact our legal department at legal@mitel.com for additional information. For a list of the worldwide Mitel Networks Corporation registered trademarks, please refer to the website: <http://www.mitel.com/trademarks>. Customer's use of this product and/or software shall be in accordance with the EULA and /or other accompanying licensing terms.

Mitel's Power Over Ethernet (PoE) Powered Device (PD) products are covered by one or more of the U.S. patents (and any foreign patent counterparts thereto) identified at Mitel's website: www.mitel.com/patents.

For more information on the PD patents that are licensed, please refer to www.cmspatents.com.

Mitel 6867i SIP Phone Release 5.0.0 User Guide

58015402 REV00 - August 2017

®,™ Trademark of Mitel Networks Corporation
© Copyrights 2017, Mitel Networks Corporation
All rights reserved

Welcome	vii
About this Guide	vii
Documentation	vii
Phone Features	vii
Requirements	viii
Installation and Setup	viii
IP Phone Keys	ix
Key Panel	ix
Key Description	x
Dialpad Keys	xii
Getting Started	xiii
Plugging in and Starting the Phone	xiii
UI Overview	xvii
UI Navigation	xxiv
Methods of Customizing Your Phone	xxvi
Phone Options via the IP Phone UI	xxvi
Phone Options via the Mitel Web UI	xxviii
Phone Status	xxxii
Phone Status via IP Phone UI	xxxii
Finding Your Phone's IP Address	xxxiv
Phone Status via the Mitel Web UI	xxxv
Customizing Your Phone	xxxvii
Language	xxxvii
Time and Date	xlvii
Directory	liii
Credentials	lvi
Call Forward	lvii
Lock	lviii
Audio	lxiii
Display	lxxi
Dialing	lxxiv
Restart	lxxv
Emergency Dial Plan	lxxvi

Line and Call Appearances lxxviii

Presence Key lxxix

 Using the Presence Key lxxx

Configuring Softkeys lxxxi

 State-Based Softkeys lxxxiii

 Softkey Display Behavior lxxxiv

 Line Key lxxxvi

 Speed Dial Key lxxxvii

 Do Not Disturb (DND) Key xcii

 Busy Lamp Field (BLF) Key xciii

 BLF/List Key xciv

 Automatic Call Distribution (ACD) Key (for Sylanro Call Managers) xcvi

 XML Key cii

 Flash Key civ

 Sprecode Key cv

 Park/Pickup Keys cvi

 Last Call Return Key cix

 Call Forward Key cx

 BLF/Xfer cxi

 Speed Dial/Xfer cxiii

 Speed Dial/Conf cxv

 Speed Dial/MWI cxvii

 Directory Key cxix

 Received Callers List Key cxxi

 Outgoing Redial Key cxxiii

 Conference Key cxxv

 Transfer Key cxxvii

 Intercom Key cxxix

 Phone Lock Key cxxx

 Paging Key cxxxii

 Discreet Ringing Key cxxxiii

 Call History Key cxxxiv

 Empty Key cxxxv

 None Key cxxxvi

Making Calls	cxxxvii
Dialing a Number	cxxxvii
Pre-Dialing a Number	cxxxvii
Using Handsfree Speakerphone	cxxxviii
Using a Headset	cxxxviii
Using Intercom Functionalitycxl
Outgoing Redial Listcxli
Mutecxlv
Receiving Calls	cxlvi
Answering an Incoming Call	cxlvi
Deflecting an Incoming Call	cxlvii
Sending an Incoming Call to Voicemail	cxlviii
Handling Calls	cxlix
Placing a Call on Hold	cxlix
Transferring Callscl
Conferencing Callsclv
Ending Callsclxi
Managing Calls	clxii
Directoryclxii
Received Callers Listclxxvi
DND and Call Forwardclxxxiii
Additional Features	cxcvi
Display DTMF Digitscxcvi
Play Call Waiting Tonecxcvii
Stuttered Dial Tonecxcviii
XML Beep Supportcxcix
Status Scroll Delaycc
Switch UI Focus to Ringing Linecci
Call Hold Reminder During Active Callsccii
Call Hold Reminder (on single hold)cciii
Call Waiting Tone Periodcciv
Preferred Line and Preferred Line Timeoutccv
Goodbye Key Cancels Incoming Callsccvii
Message Waiting Indicatorccviii

Incoming Intercom Call Features CCix

Group RTP Paging CCxi

Shared Call Appearance (SCA) Call Bridging CCxii

BroadSoft BroadWorks Executive and Assistant Services CCxv

Star Codes CCxxvii

Other Features CCxxviii

Model M680i and M685i Expansion Modules CCxxix

 Using the Expansion Modules CCxxx

Troubleshooting Solutions CCxxxi

 Why is my display blank? CCxxxi

 Why is my speakerphone not working? CCxxxi

 Why can't I get a dial tone? CCxxxi

 Why doesn't my phone ring? CCxxxi

 Why is the light not coming on with a new voicemail message? CCxxxi

 Why is my handset not working? CCxxxi

 How do I find the IP address of my phone? CCxxxii

 Why does my phone display the No Service message? CCxxxii

 How do I change my user password? CCxxxii

 Why does my phone display Bad Encrypted Config? CCxxxii

 How do I restart the IP phone? CCxxxii

 How do I lock my phone? CCxxxii

Limited Warranty. CCxxxiii

 Exclusions CCxxxiii

 Warranty Repair Services CCxxxiii

 After Warranty Service CCxxxiii

Limited Warranty (Australia Only). CCxxxiv

 Repair Notice CCxxxiv

 Exclusions CCxxxiv

 Warranty Repair Services CCxxxv

 After Warranty Service CCxxxv

Appendix A - Time Zone Codes CCxxxvi

WELCOME

The Mitel 6867i is a 24-line SIP phone designed for power users who demand a lot from both their phones and their networks. The Mitel 6867i provides remarkable HD wideband audio and an enhanced speakerphone that utilizes advanced audio processing to achieve richer and clearer handsfree conversations. Supporting today's high speed networks through dual Gigabit Ethernet ports, the 6867i offers a large color LCD display, 6 programmable soft keys, 4 programmable context sensitive system keys and native DHSG/EHS and USB headset support. With its fully customizable hard key layout, XML capabilities, and an environmentally efficient PoE class 2 rating, the 6867i is one of the most advanced SIP desktop phones available on the market today.

ABOUT THIS GUIDE

This guide explains how to use the basic features of your new 6867i phone. Not all features listed are available by default. Contact your System or Network Administrator to find out which features and services are available to you on your system. Your System Administrator has the ability to customize some features on this phone. For information on more advanced settings and configurations, Administrators should refer to the *Mitel SIP IP Phones Administrator Guide*.

DOCUMENTATION

- ***Mitel 6867i SIP IP Phone Quick Reference Guide*** – Contains call handling instructions, an overview of the User Interface (UI) and details on UI navigation, as well as information on other important features. The Quick Reference Guide can be downloaded from <http://www.miteldocs.com>.
- ***Mitel 6867i SIP IP Phone Installation Guide*** – Contains installation and set-up instructions, general features and functions, and basic options list customization. The Installation Guide can be downloaded from <http://www.miteldocs.com>.
- ***Mitel 6867i SIP IP Phone User Guide*** – Describes the most commonly used features and functions for an end user. The User Guide can be downloaded from <http://www.miteldocs.com>.
- ***Mitel SIP IP Phones Administrator Guide*** – Describes how to set up the Mitel SIP IP phones on the network and contains advanced configuration instructions. The Administrator Guide is intended for the System Administrator and can be downloaded from <http://www.miteldocs.com>.

PHONE FEATURES

- 3.5" QVGA color TFT LCD with backlight
- Built-in, two-port 10/100/1000 Gigabit Ethernet switch – lets you share a connection with your computer
- USB 2.0 port (100mA maximum)
- 6 programmable and 4 context-sensitive softkeys

- Press-and-hold speed dial key configuration feature
- Supports up to 24 call lines with LEDs
- Wideband handset
- Wideband, full-duplex speakerphone for handsfree calls
- Headset mode support
- AC power adapter (sold separately)
- Enhanced busy lamp fields*
- Set paging*

*Availability of feature dependent on your phone system or service provider.

REQUIREMENTS

The 6867i requires the following environment:

- SIP-based IP PBX system or network installed and running with a SIP account created for the 6867i phone
- Access to a Trivial File Transfer Protocol (TFTP), File Transfer Protocol (FTP), Hypertext Transfer Protocol (HTTP) server, or Hyper Text Transfer Protocol over Secure Sockets Layer (SSL) (HTTPS)
- Ethernet/Fast Ethernet LAN (10/100 Mbps) (Gigabit Ethernet LAN [1000 Mbps] recommended)
- Category 5/5e straight-through cabling (Category 6 straight-through cabling required for optimum Gigabit Ethernet performance)
- Power source:
 - For Ethernet networks that supply inline power to the phone (IEEE 802.3af) use an Ethernet cable to connect from the phone directly to the network for power (no 48V AC power adapter required if using Power-over-Ethernet [PoE])
 - For Ethernet networks that DO NOT supply power to the phone:
 - Use only the GlobTek Inc. Limited Power Source [LPS] adapter model no. GT-41080-1848 (sold separately) to connect from the DC power port on the phone to a power source
or
 - Use a PoE power injector or a PoE switch

INSTALLATION AND SETUP

If your System Administrator has not already setup your 6867i phone, please refer to the **Mitel 6867i Installation Guide** for basic installation and physical setup information. For more advanced administration and configuration information, System Administrators should refer to the **Mitel SIP IP Phones Administrator Guide**.

IP PHONE KEYS

KEY PANEL



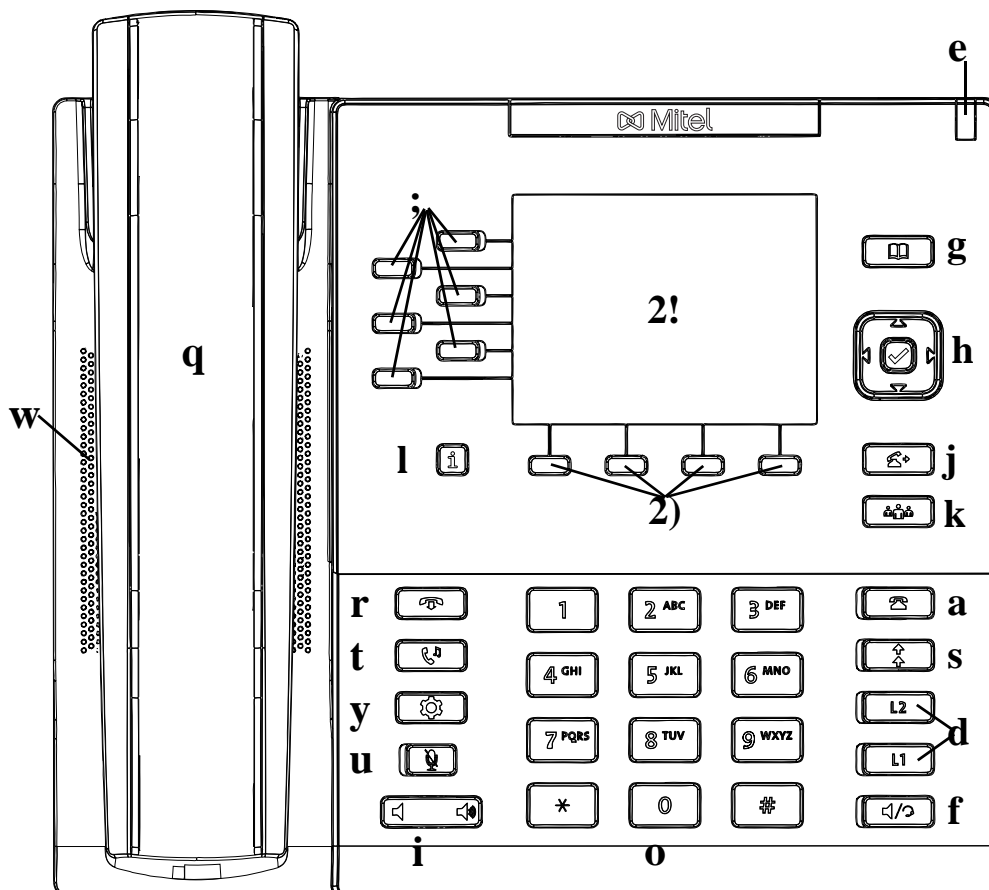







The following sections describe the various 6867i phone key functions and how they can help you make and manage your calls and caller information.

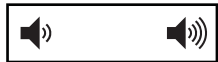

q	6867i Handset	d	Line/Call Appearance Keys
w	High Quality Speakerphone	f	Speaker/Headset Key
e	Message Waiting Indicator	g	Directory Key
r	Goodbye Key	h	Navigation Keys/Select Button
t	Hold Key	j	Transfer Key
y	Options Key	k	Conference Key
u	Mute Key	l	Presence Key
i	Volume Control	;	Programmable Softkeys
o	Dialpad	2)	Context-Sensitive Softkeys
a	Received Callers List Key	2!	TFT LCD Screen
s	Outgoing Redial Key		

KEY DESCRIPTION

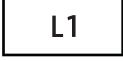
The following table describes the keys on the 6867i:

KEY	DESCRIPTION
	Goodbye Key - Ends an active call. The Goodbye key also exits an open list, such as the Options List, without saving changes.
	Hold Key - Places an active call on hold. To retrieve a held call, press the Hold key again or press the Pickup softkey offered on the display. For more information, see “Placing a Call on Hold” on page cxlix.
	Options Key - Accesses services and options to customize your phone. Your System Administrator may have already customized some of your settings. Check with your System Administrator before changing any Administrator-only options. For more information, see “Phone Options via the IP Phone UI” on page xxvi.
	Mute Key - Mutes the microphone so that your caller cannot hear you (the light indicator flashes when the microphone is on mute). For more information, see “Mute” on page cxlv.
	Volume Controls - Adjusts the volume for the handset, ringer, and handsfree speakerphone.
	Received Callers List Key - Accesses a list of the last 200 calls received. For more information, see “Received Callers List” on page clxxvi.
	Outgoing Redial Key - Accesses a list of the last 100 previously dialed numbers. Pressing the Outgoing Redial key twice redials the last dialed number. For more information, see “Outgoing Redial List” on page cxli.
	Line/Call Appearance Keys - Connects you to a line or call. The Mitel 6867i IP phone has two default Line keys, each with LED indicator lights. For more information, see “Line and Call Appearances” on page lxxviii.
	
	Speaker/Headset Key - Transfers the active call to the speaker or headset, allowing handsfree use of the phone. For more information, see “Using Handsfree Speakerphone” on page cxxxviii.
	Directory Key - Accesses a directory of names and phone numbers. For more information, see “Directory” on page clxii.

KEY

DESCRIPTION



Navigation Keys/Select Button - Multi-directional navigation keys allow you to navigate through the phone's user interface. Pressing the center Select button selects/sets options and performs various actions (such as dialing out when in the Directory, Received Callers, and Outgoing Redial Lists).

For more information, see ["UI Navigation"](#) on page xxiv.



Transfer Key - Transfers the active call to another number.

For more information, see ["Transferring Calls"](#) on page cl.

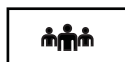

Conference Key - Begins a conference call with the active call.

For more information, see ["Conferencing Calls"](#) on page clv.



Presence Key - Accesses the partial and full contact presence information screens, which provide more detailed information about the selected contact.

For more information see ["Presence Key"](#) on page lxxix.



Left Softkeys - 6 programmable keys that allow you to easily perform up to 20 specific functions and access enhanced services provided by third parties (e.g. XML applications).

For more information see ["Configuring Softkeys"](#) on page lxxxii.

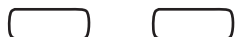

Bottom Softkeys - 4 programmable keys that support up to 18 functions. These keys also act as state-based keys allowing you to easily perform context-sensitive functions during specific states (i.e. when the phone is an idle, connected, incoming, outgoing, or busy state).

For more information see ["Configuring Softkeys"](#) on page lxxxii.

DIALPAD KEYS

The 6867i has a dialpad with digits from 0 through 9, a * key, and a # key. Keys 2 through 9 contain the letters of the alphabet. The 6867i phone dialpad includes the following:

DIALPAD KEY	DESCRIPTION
0	Dials 0 Dials the Operator on a registered phone
1	Dials 1
2 ABC	Dials 2 When entering text, this key enters A with one press, B with two presses, and C with three presses
3 DEF	Dials 3 When entering text, this key enters D with one press, E with two presses, and F with three presses
4 GHI	Dials 4 When entering text, this key enters G with one press, H with two presses, and I with three presses
5 JKL	Dials 5 When entering text, this key enters J with one press, K with two presses, and L with three presses
6 MNO	Dials 6 When entering text, this key enters M with one press, N with two presses, and O with three presses
7 P QRS	Dials 7 When entering text, this key enters P with one press, Q with two presses, R with three presses, and S with four presses.
8 TUV	Dials 8 When entering text, this key enters T with one press, U with two presses, and V with three presses
9 WXYZ	Dials 9 When entering text, this key enters W with one press, X with two presses, Y with three presses, and Z with four presses.

The * is called the star key. The # is called the number sign, pound key, or hash key, depending on one's nationality or personal preference. These can be used for special functions such as accessing voicemail. The star key and pound key functions are dependent on your country's feature availability. Contact your System Administrator for more information about available functions using these keys.

These dialpad keys can be used for any of the following on the phone:

- Dial a phone number to make a call (see [“Dialing a Number”](#) on [page cxxxvii](#))
- Enter digits or letters in the IP phone user interface
- Program a speed dial number (see [“Speed Dial Key”](#) on [page lxxxvii](#))
- Press a speed dial key (see [“Speed Dial Key”](#) on [page lxxxvii](#))
- Press the keys associated with a called Interactive Voice Response (IVR) system

GETTING STARTED

The 6867i must be set up and be configured prior to its first use. This section describes phone behavior and start up screens you may see when the phone is first plugged in, or when it is restarted.

PLUGGING IN AND STARTING THE PHONE

The 6867i automatically begins the start up sequence as soon as it is connected. The phone goes through this process the first time you plug in your phone and every time you restart your phone.

The phone displays the following startup screens.



The 6867i phone then checks settings and looks for new configuration and firmware updates from a configuration server. This may take a few moments while the phone downloads the latest updates.



Note: New updates to your phone can be automatically scheduled from the server. This is set up on the phone system by your System Administrator and should be scheduled during non-business hours or slow call periods.



WARNING: DO NOT UNPLUG OR REMOVE POWER TO THE PHONE WHILE IT IS CHECKING OR INSTALLING FIRMWARE AND CONFIGURATION INFORMATION.

If language packs were loaded to your phone by your System Administrator, the following screen displays during startup.



When the configuration update is complete, the phone displays the following screens and then displays the **Home** screen.

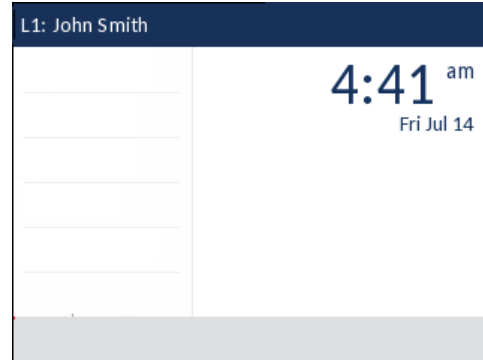

NETWORK CONNECTED/NETWORK DISCONNECTED

If your phone successfully connects to the network the phone will go directly to the **Home** screen.

If your phone did not successfully connect to the network, the **Network Disconnected** prompt appears on the display and the telephone status light turns on.

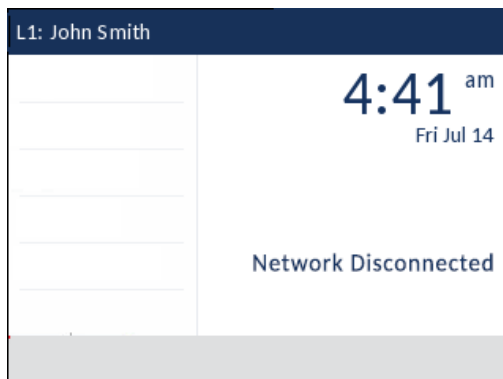

Check that the cables are tightly connected to the phone and to the wall jack. The phone should automatically detect when it is reconnected and remove the **Network Disconnected** prompt from the screen. However, if changes have been made to your phone's network settings, you may need to restart your phone. Check with your System or Network Administrator for assistance.

For more information about connecting your phone, see the *Mitel 6867i IP Phone Installation Guide*.



Note: If the phone displays a **No Service** status message you can still use the phone but note that it is not registered with the Registrar. For more information about registering your phone, contact your System Administrator.

UI OVERVIEW

HOME SCREEN

When the phone has successfully updated the configuration and connected to the network, the phone displays the **Home** screen. The **Home** screen displays the current line, your name (SIP screen name), the date and time, and various important status messages. It is the default screen displayed when the phone is in an idle state.





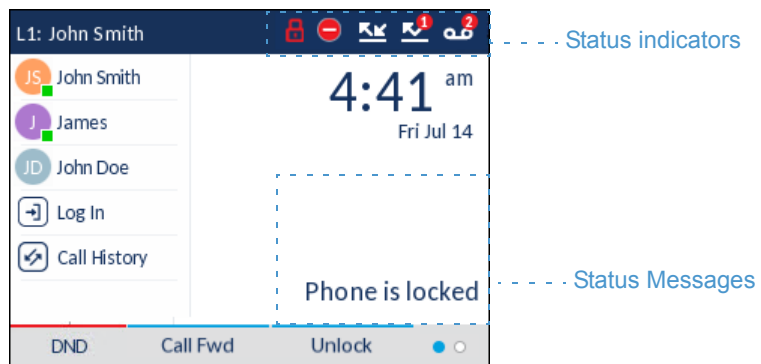

Note: Your System Administrator should have configured your SIP screen name, line number, and any other administrative features required. If your name does not display on the screen, contact your System Administrator.

Phone/Line Status Indicators and Messages

There are icons that display on the phone to indicate the status of the phone and/or the status of the line. These icons display on the upper right corner of the **Home** screen.



The following table identifies and describes the phone/line status indicators on the **Home** screen.

ICON	DESCRIPTION
	Phone Locked - The lock icon displays on the Home screen indicating that the phone is in a locked state preventing the phone from being used and preventing any changes from being made to the phone.
	Voicemail - The voicemail icon displays on the Home screen only if you have new messages waiting. The number in the red circle indicates how many new messages you have (from 1 to 9; if the total number of pending messages is greater than 9, an exclamation mark "!" is displayed). To access your voicemail messages, use the star codes for your system if a voicemail softkey has not been configured on your phone. For more information on your system's star codes, please refer to the documentation for the voicemail system you are using. Note: Depending on your call manager, the voicemail icon may not indicate the number of pending messages, but instead just indicate messages are pending by the use of an exclamation mark "!".
	Missed Calls - The Missed Calls icon displays on the Home screen only when incoming calls have not been received. The number in the red circle indicates how many calls were missed. To access a list of your missed calls, press the Received Callers List key.
	Do Not Disturb - The Do Not Disturb (DND) icon displays on the Home screen when the DND feature is enabled. When DND is enabled, callers calling into the phone hear a busy signal or a message, depending on the configuration.
	Call Forward - The Call Forward icon displays on the Home screen when the Call Forward feature is enabled. When Call Forward is enabled, incoming phone calls are automatically forwarded to a defined number when your phone is in a busy state and/or when the call is not answered after a specified number of rings.

In addition to the phone/line status indicators, status messages with regards to the following are displayed on the **Home** screen when the situation arises:

- Number of missed calls
- Phone lock status
- SCA Caller IDs
- XML-related text
- Network status

Softkeys

6 left softkeys and 4 bottom softkeys are always displayed on the **Home** screen. You can configure the left softkeys with up to 20 functions and configure the bottom softkeys with up to 18 functions as required.



Note: For more information about configuring the left and bottom softkeys, see “[Configuring Softkeys](#)” on [page lxxxi](#).

If you or your Administrator have configured softkey functions on your phone, the labels for those functions display on the screen. For example, in the illustration above **XML Menu** and **Voicemail** were configured as XML and speed dial keys respectively and the remaining three left softkeys were configured as **Busy Lamp Field** (BLF) keys. The bottom set of softkeys were configured as **DND** (Do Not Disturb), **Call FWD** (Call Forward), and **Lock/Unlock** respectively.

A **More** softkey as indicated by dots is also displayed at the bottom right of the screen if you have configured more softkeys than can be displayed at one time. These dots indicate the number of softkey pages and its relative position.

Off-Hook and Dialing Screen

When you pickup the handset on the **Home** screen, the screen displays as follows:

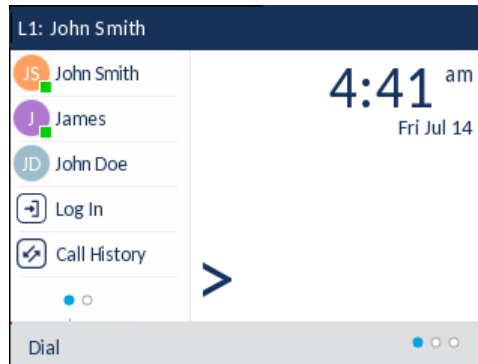

This screen displays the Dial key at the bottom. This key is context-sensitive and cannot be changed.

The **More** softkey is also displayed if you have any configured bottom softkeys. For example, in the previous figure, the 6867i has three softkeys configured that are viewable on the next softkey “page”. Pressing the **More** softkey toggles between the first and additional “pages” to display all the rest of the configured softkeys (as per the figure below).

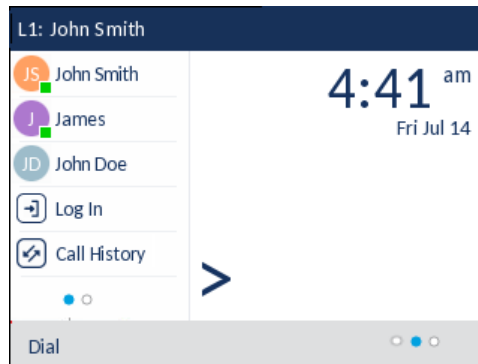

LINE SELECTION SCREEN

The **Line Selection** screen displays a list of the lines that are available on the phone as well as line usage indicators that tell you whether or not a line is in use.

It also allows you to easily select a line to act upon. When a line is not in use, a **New Call** key is available allowing you to dial out using the selected line. If the line is in use with a call on hold, a **Pickup** key is available allowing you to pick up the call on hold on the respective line.

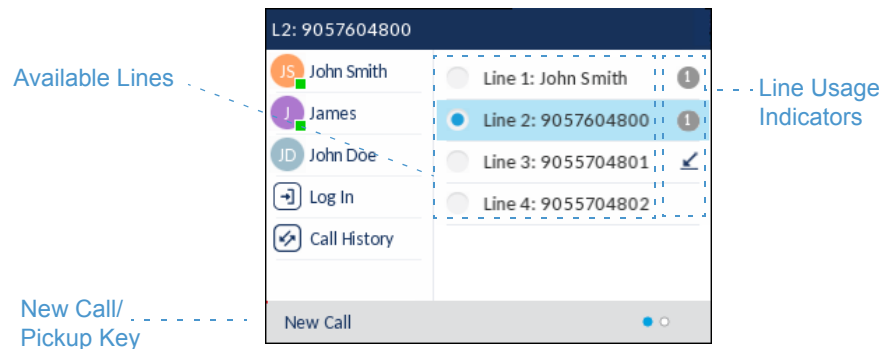

The following table identifies and describes the line usage indicators on the **Line Selection** screen.

INDICATOR/ICON	DESCRIPTION
N/A	No icon denotes that no calls are associated with the line and the line is available to be used.
1	The number denotes how many call appearances are being utilized on the respective line.
↙	Indicates a call is incoming on the respective line.
↗	Indicates a call is outgoing on the respective line.

DETAILED-VIEW CALL SCREEN

The **Detailed-View Call** screen brings into focus all the information available for a specific call. It is the default screen displayed for all active point-to-point calls.

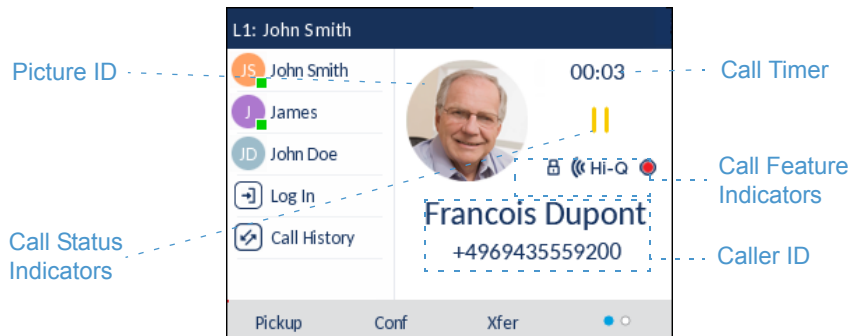

The **Detailed-View Call** screen encompasses the picture ID of the remote party (if available), a call timer indicating the duration of the call in focus (in minutes and seconds), the caller ID (name and number), and call status and feature indicators.

The following table identifies and describes the call status and call feature indicators on the **Detailed-View Call** screen.

INDICATOR/ICON DESCRIPTION

Call Status Indicators

N/A	No icon denotes that the call is connected and in progress.
	Indicates the call is on hold.
↙	Indicates the call is an incoming call.
↗	Indicates the call is an outgoing call.
👤 👤	Indicates the party is a conference call participant. The direction of the arrow denotes where the other conference call participant is in the list of calls.

Call Feature Indicators

🔒	Indicates the call is secured using TLS/SRTP encryption.
🔊 Hi-Q	Indicates the call is using Mitel Hi-Q™ audio.
📍	Indicates active VoIP recording is enabled and the call is being recorded.

MULTI-VIEW CALL SCREEN



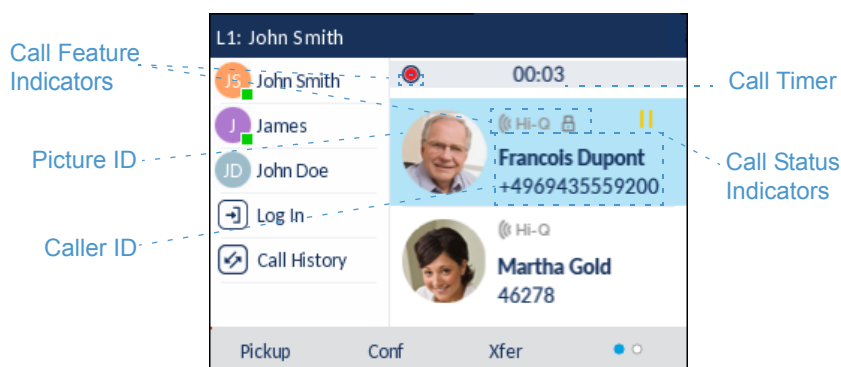

The **Multi-View Call** screen allows you to manage your calls more efficiently when you have more than one call in progress. It is particularly useful in transfer and conference scenarios. All pertinent information from the **Detailed-View Call** screen is also available on the **Multi-View Call** screen but information for two remote parties can be seen simultaneously.





The following table identifies and describes the call status and call feature indicators on the **Multi-View Call** screen.

INDICATOR/ICON DESCRIPTION

Call Status Indicators

N/A	No icon denotes that the call is connected and in progress.
	Indicates the call is on hold.
	Indicates the call is an incoming call.
	Indicates the call is an outgoing call.
	Indicates the party is a conference call participant. The direction of the arrow (if applicable) denotes where the other conference call participant is in the list of calls.

Call Feature Indicators

	Indicates the call is secured using TLS/SRTP encryption.
	Indicates the call is using Mitel Hi-Q™ audio.
	Indicates active VoIP recording is enabled and the call is being recorded.

UI NAVIGATION

UI navigation is easily performed using the navigation keys located to the right of the LCD screen.

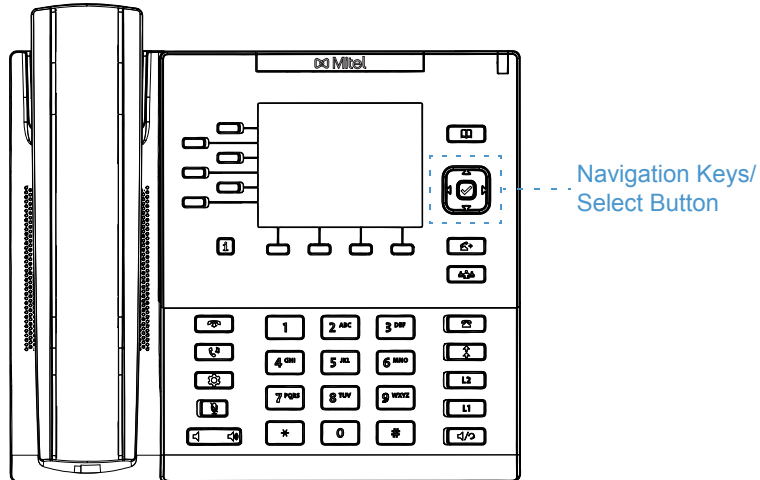

The left and right navigation keys are used to switch to the different screens and the ▲ and ▼ keys are used to highlight and scroll through the different lines/calls on the respective screen. Pressing the center button selects/sets options and performs various actions (such as dialing out when in the Directory, Received Callers, and Outgoing Redial Lists).

The figure below provides a visual representation of the different screens and the UI behavior when a navigation key is pressed.

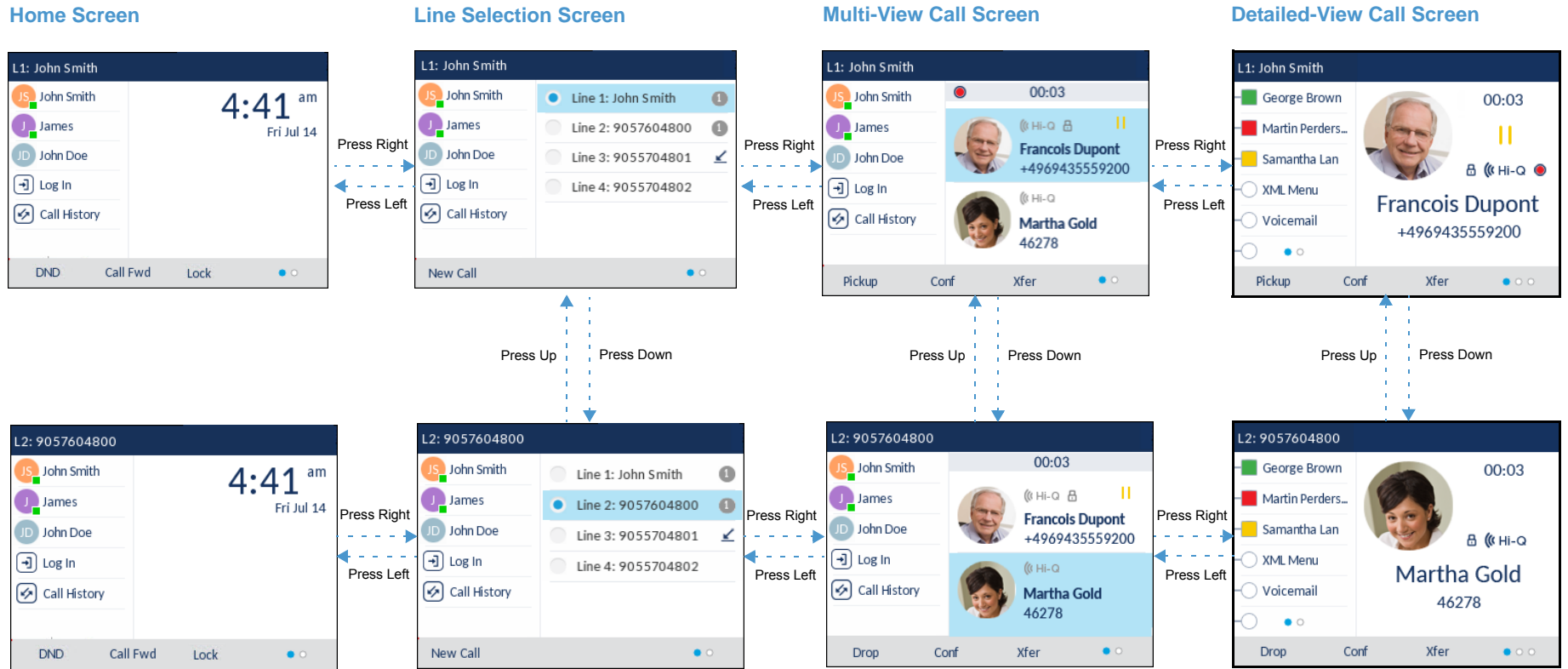

Note: The **Detailed-View Call** screen is only accessible when at least one call is in a ringing or connected state. Moreover, the **Multi-View Call** screen is only accessible when more than one call is a ringing or connected state.

















METHODS OF CUSTOMIZING YOUR PHONE







There are two ways to customize specific options on your phone:

- Using the **Options**  key on the IP phone
- Using the Mitel Web UI in an Internet browser window from your PC

PHONE OPTIONS VIA THE IP PHONE UI

You can customize your phone by pressing the  key and accessing the IP phone UI. These options allow you to customize the following phone settings:

ICON	OPTION
	Status
	Language
	Time and Date
	<ul style="list-style-type: none"> • Settings
	<ul style="list-style-type: none"> • Time Zone
	<ul style="list-style-type: none"> • Set Date and Time
	Directory
	<ul style="list-style-type: none"> • Settings (available only if external directory sources are configured by your Administrator)
	<ul style="list-style-type: none"> • External Sources (available only if external directory sources are configured by your Administrator)
	Call Forward
	Lock
	<ul style="list-style-type: none"> • Password
	<ul style="list-style-type: none"> • Phone Lock
	Audio
	<ul style="list-style-type: none"> • Audio Mode
	<ul style="list-style-type: none"> • Headset
	<ul style="list-style-type: none"> • Ring Tones











ICON	OPTION
	• Tone Set
	Display
	Dialing
	• Live Dialpad
	• Speed Dial Edit
	Restart



Note: The **Advanced** options are Administrator-level functions only, and are not accessible by the user. These options should only be set up and changed by your System Administrator.

SIMPLIFIED OPTIONS LIST

Your System Administrator may configure a simplified Options List for your phone. The following table indicates the options that may appear on your phone if the simplified Options List is applied.

ICON	OPTION
	Status
	Call Forward
	Lock
	Audio
	• Audio Mode
	• Headset
	• Ring Tones
	• Tone Set
	Display
	Restart





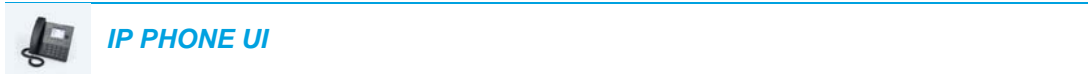

Note: The **Advanced** options are Administrator-level functions only, and are not accessible by the user. These options should only be set up and changed by your System Administrator.

USING THE IP PHONE UI

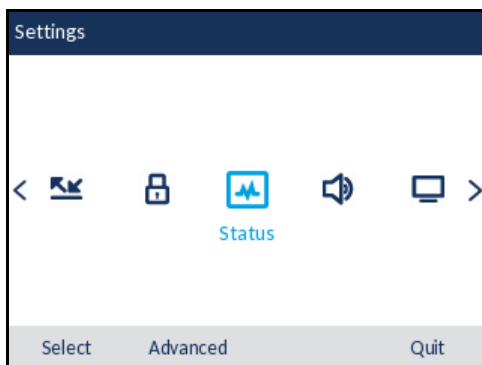

1. Press  on the phone to enter the Options List.



2. To go to an option, use left and right to navigate to the main option and  and  to scroll through the sub options.
3. Press the  button or **Select** softkey to select an option.
4. Use the navigation keys, dialpad keys, and softkeys that display for each option to make any desired changes.
5. Press the **Save** softkey to save your changes.
6. Press the  button or the **Quit** softkey at any time to exit without saving changes.



Notes:

1. For more information about customizing your phone using the available options from the IP phone UI, see ["Customizing Your Phone"](#) on [page xxxvii](#).
2. For more information about **Advanced** options, contact your System Administrator.

PHONE OPTIONS VIA THE MITEL WEB UI

In addition to the IP phone UI options, you can customize options on the IP phone using the Mitel Web UI. In order to access your phone using the Mitel Web UI, you need to know your phone's IP address. To find your phone's IP address, see ["Finding Your Phone's IP Address"](#) on [page xxxiv](#).

USING THE MITEL WEB UI



1. Open your web browser, enter the phone's IP address or host name into the address field and press **Enter**. The following logon screen displays.



2. At the prompt, enter your username and password and click **OK**. The **Status** window displays for the IP phone you are accessing.



Note: For a user, the default username is “user” and the password field is left blank.

Mitel 6867i Log Off

Status

- System Information
- Operation
 - User Password
 - Phone Lock
 - Softkeys and XML
 - Keypad Speed Dial
 - Directory
 - Reset
- Basic Settings
 - Preferences
 - Account Configuration
 - Custom Ringtones

System Information

Network Status

Attribute	LAN Port	PC Port
Link State	Up	Down
Negotiation	Auto	Auto
Speed	100Mbps	10Mbps
Duplex	Full	Half

Hardware Information

Attribute	Value
MAC Address	00:08:00:08:00:08
Platform	6867i Revision 0

Firmware Information

Attribute	Value
Firmware Version	4.0.0.10
Firmware Release Code	SIP
Boot Version	Boot2 1.0.0.8 May 2 2014 08:09
Date/Time	Sep 4 2014 05:39:31

SIP Status

Line	SIP Account	Status	Backup Registrar Used?
1	650@prox.com:0	Registered	No
2	651@prox.com:0	Registered	No
3	653@prox.com:0	Registered	No
4	654@prox.com:0	Registered	No

3. You can logout of the Mitel Web UI at any time by clicking **Log Off**.

The following categories display in the side menu of the Mitel Web UI: **Status**, **Operation**, and **Basic Settings**.

CATEGORY DESCRIPTION

Status	The Status section displays the network status and the MAC address of the IP phone. It also displays hardware and firmware information regarding the IP phone, and information about the SIP account(s) currently configured on the phone. The information in the Status window is read-only.
--------	---

Operation	<p>User Password - Allows you to change the user password.</p> <p>Phone Lock - Allows you to assign an emergency dial plan to the phone, lock the phone to prevent any changes to the phone and to prevent use of the phone, as well as reset the user password.</p> <p>Softkeys and XML - Allows you to configure up to 6 left softkeys and 4 bottom softkeys with functions identified in the list below.</p>
-----------	--

Available functions for softkeys:

- None
- Line
- Speed Dial
- Do Not Disturb (DND)
- Busy Lamp Field (BLF)
- BLF/List
- Auto Call Distribution (ACD)
- Extensible Markup Language (XML)
- Flash
- Sprecode
- Park
- Pickup
- Last Call Return
- Call Forward
- BLF/Xfer
- Speed Dial/Xfer
- Speed Dial/Conf
- Speed Dial/MWI
- Directory
- Filter
- Callers List
- Redial
- Conference
- Transfer
- Intercom (Icom)
- Phone Lock
- Paging
- Login
- Discreet Ringing
- Call History
- Empty

Keypad Speed Dial - Allows you to assign a speed dial number to a specific digit on the phone's keypad/dialpad for speed dialing purposes.

Expansion Module - Allows you to configure an additional 16 softkeys with an M680i Expansion Module or an additional 84 softkeys with an M685i Expansion Module if it is attached to the phone. This option displays on the side menu of the Mitel Web UI only if an Expansion Module is attached.

Directory - Allows you to copy the Received Callers List and Local Directory from your IP phone to your PC.

Reset - Allows you to restart the IP phone when required.

CATEGORY	DESCRIPTION
----------	-------------

Basic Settings

Preferences - Allows you to enable/disable the following:

- Park Call
- Pick Up Parked Call
- Display DTMF Digits
- Play Call Waiting Tone
- Stuttered Dial Tone
- XML Beep Support
- Status Scroll Delay (seconds)
- Switch UI Focus to Ringing Line
- Call Hold Reminder During Active Calls
- Call Hold Reminder
- Call Waiting Tone Period
- Preferred line
- Preferred line Timeout (seconds)
- Goodbye Key Cancels Incoming Call
- Message Waiting Indicator Line
- DND Key Mode
- Call Forward Key Mode

This category also allows you to configure:

- Incoming Intercom Call Settings
- Group Paging RTP Settings
- Ring Tones (global and per-line basis)
- Time and Date Settings
- Language Settings

Account Configuration - Allows you to configure DND and Call Forward by account. You can have multiple accounts on the 6867i.

Custom Ringtones - Allows you to upload up to 8 custom WAV file ringtones on the phone that can be used as your incoming ring tone.

PHONE STATUS

You can view the status of your phone using the IP phone UI or the Mitel Web UI.





PHONE STATUS VIA IP PHONE UI

The **Status** option on the IP phone displays the status of your phone to the LCD display.

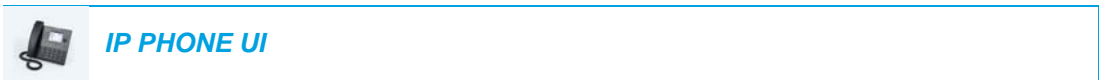
This option allows you to view your phone's:

- Firmware information including platform, firmware version, and boot version
- Network status including your phone's IP, MAC address, and LAN/PC port information
- Storage information including how many records are stored in your Local Directory, Received Callers, and Outgoing Redial lists
- Error messages from the last reboot or startup
- Copyright information



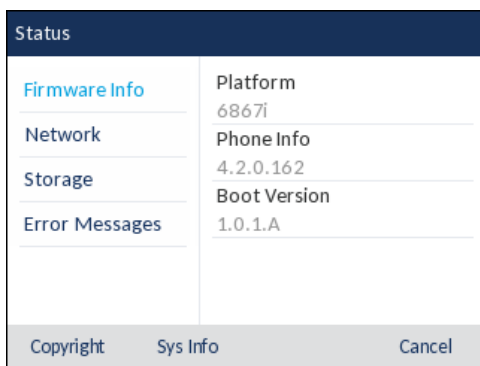

1. Press  on the phone to enter the Options List.
2. Press the  button to enter the **Status** menu.
3. Use the  and  keys to scroll the through the following status items:
 - Firmware Info



- Network

Status	
Firmware Info	IP Address 10.30.100.102
Network	MAC Address 00085D3E7691
Storage	LAN Port 1000/Full (Auto)
Error Messages	PC Port Link Down
Sys Info Cancel	



- Storage

Status	
Firmware Info	Directory List 5/1000 
Network	Callers List 40/200 
Storage	Redial List 77/100 
Error Messages	
Sys Info Cancel	



Notes:

1. The Directory List detailed in the Storage menu is in reference to the Local Directory.
2. If the Received Callers List or Outgoing Redial List is full, the Storage screen displays information regarding the age of the oldest record stored in memory for the respective list instead of the total number of records stored

Status	
Firmware Info	Directory List 1000/1000 
Network	Callers List 20 days 
Storage	Redial List 30 days 
Error Messages	
Cancel	

- Error Messages

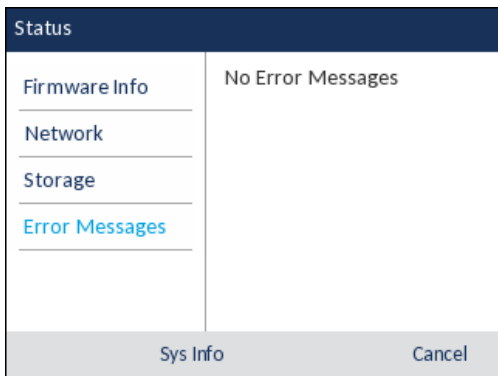



Notes:

1. Press the **Copyright** softkey to view copyright information.
2. The **Status** menu may also contain a section called **Accessory Info**. This section details the firmware versions of all the accessories attached to your phone.

FINDING YOUR PHONE'S IP ADDRESS

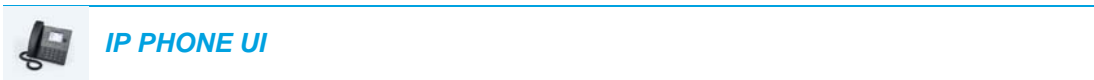
If you want to access your phone's options using an Internet browser, you need to enter the IP address of the phone in the browser to open the Mitel Web UI. Use the following procedure to find your phone's IP address.



1. Press  to enter the Options List.
2. Press the  button to enter the **Status** menu.

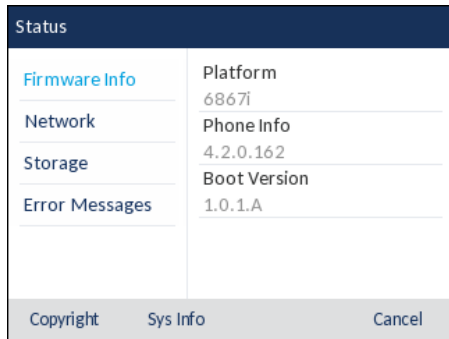

- Use the **▲** key to highlight **Network**.
The IP address of your 6867i displays in the **IP Address** field in the right column.

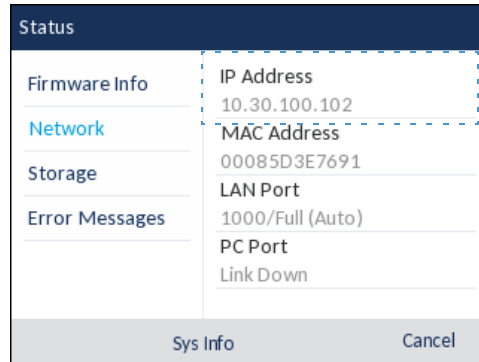

PHONE STATUS VIA THE MITEL WEB UI

Use the following procedure to view the phone status via the Mitel Web UI.

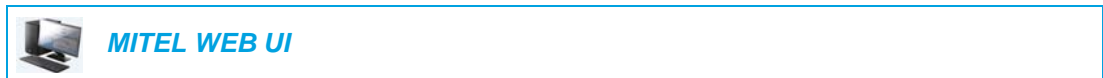

- Open your web browser, enter the phone's IP address or host name into the address field and press **Enter**.
- In the Username/Password window, enter your username and password and click **OK**. The **Status** window displays for the IP phone you are accessing.



Note: The default username is **user** and the password field is left blank.

System Information

Network Status			
Attribute	LAN Port	PC Port	
Link State	Up	Down	
Negotiation	Auto	Auto	
Speed	100Mbps	10Mbps	
Duplex	Full	Half	

Hardware Information

Attribute	Value
MAC Address:	00:08:00:08:00:08
Platform	6867i Revision 0

Firmware Information

Attribute	Value
Firmware Version	4.0.0.10
Firmware Release Code	SIP
Boot Version	Boot2 1.0.0.6 May 2 2014 06:09
Date/Time	Sep 4 2014 05:39:31

SIP Status

Line	SIP Account	Status	Backup Registrar Used?
1	650@proxy.com:0	Registered	No
2	651@proxy.com:0	Registered	No
3	653@proxy.com:0	Registered	No
4	654@proxy.com:0	Registered	No

This **Status** window displays the status of your phone, which includes the following information:

- Network Status
- Hardware Information
- Firmware Information
- SIP Status

SIP ACCOUNT STATUS

The IP phones show the SIP registration status on the IP phone's **Status** screen in the Mitel Web UI.

SIP Status			
Line	SIP Account	Status	Backup Registrar Used?
1	650@proxy.com:5060	Registered	Yes
2	651@proxy.com:5060	Registered	Yes
3	652@proxy.com:5060	Registered	Yes
4	653@proxy.com:5060	401	No

The following table describes the status conditions that can display for the account.

STATUS CONDITION DESCRIPTION

Registered Displays this status on accounts that HAVE been registered with the SIP proxy server.

Example:

Line	SIP Account	Status	Backup Registrar Used?
1	650@proxy.com:5060	Registered	Yes

where:

- Account Number is 1
- SIP Account is 650@proxy.com on port 5060
- Status is Registered
- Backup registrar is used (Yes)

SIP Error Number Displays on accounts when registration fails with the SIP proxy server.

Example:

Line	SIP Account	Status	Backup Registrar Used?
4	653@proxy.com:5060	401	No

where:

- Account Number is 4
- SIP Account is 653@proxy.com on port 5060
- Status is 401 - Unregistered if SIP registration fails
- Backup registrar is used (No)

CUSTOMIZING YOUR PHONE

The following paragraphs describe the options available from either the IP phone UI, the Mitel Web UI, or both, and provide procedures applicable to the option.

LANGUAGE

IP PHONE UI AND WEB UI LANGUAGE

The IP phones support several different languages. You can have the IP phone UI and the Mitel Web UI display in a specific language as required. When you set the language to use, all of the display screens (menus, services, options, configuration parameters, etc.) display in that language. The IP phones support the following languages:

- English
- Czech
- Catalan
- Valencian
- Welsh
- German
- Danish
- Spanish
- Mexican Spanish
- Euskera
- Finnish
- French
- Galego
- Canadian French
- Hungarian
- Italian
- Dutch
- Dutch (Netherlands)
- Norwegian
- Polish
- Portuguese
- Portuguese Brazilian
- Romanian
- Russian

- Slovak
- Swedish
- Turkish
- Greek



SPECIFYING THE LANGUAGE TO USE USING THE IP PHONE UI

Once the language pack(s) are available on your phone from your System Administrator, you can specify which language to use on the phone and/or the Mitel Web UI.



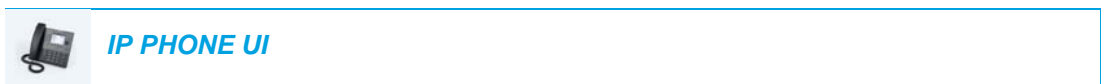

Note: All languages may not be available for selection. The available languages are dependent on the language packs currently loaded to the IP phone.

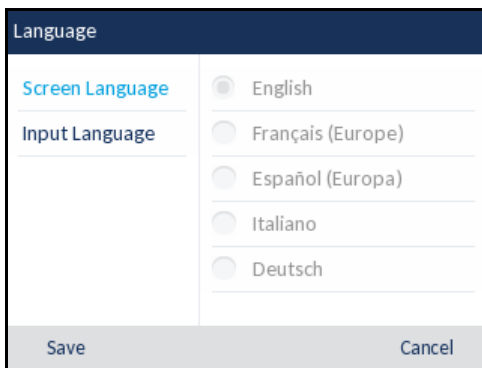

1. Press  on the phone to enter the Options List.
2. Navigate to the **Language** option and press the  button or **Select** softkey.



3. With **Screen Language** highlighted press the  key to move to selection column.
4. Use the  and  keys to scroll through and choose the desired screen language.



Note: All languages may not be available for selection. The available languages are dependent on the language packs currently loaded to the IP phone. English is the default language and cannot be changed or removed. For more information about loading language packs, see your System Administrator.

5. Press the **Save** softkey to save your changes.
The change is dynamic. When you exit the Options List, the phone will display all menu items in the language you selected.

SPECIFYING THE LANGUAGE TO USE USING THE MITEL WEB UI



MITEL WEB UI

1. Click on **Basic Settings > Preferences > Language Settings**.

2. In the **Webpage Language** field, select a language to apply to the Mitel Web UI.



Note: All languages may not be available for selection. The available languages are dependent on the language packs currently loaded to the IP phone by your System Administrator. English is the default language and cannot be changed or removed.

3. Click **Save Settings**.

The change is dynamic. The Mitel Web UI will display all screens in the language you selected.



Note: You must have the language pack(s) already loaded to your phone in order to use them. For more information about loading language packs, contact your System Administrator.

INPUT LANGUAGE

The 6867i supports text and character inputs in various languages (English, German, French, Spanish, Italian, Portuguese, Russian, Nordic, and Greek). Inputting textual or character information into the IP phone UI can be done using the dialpad on the phone. You can configure the **Input Language** feature using the Mitel Web UI or the IP phone UI.

The following tables identify the language characters that you can use to enter text and characters on the 6867i.

Dialpad Input Alphabet Tables

English

KEY	UPPERCASE CHARACTERS	LOWERCASE CHARACTERS
0	0	0
1	1.;=_,'&()[]\$!	1.;=_,'&()[]\$!
2	ABC2	abc2
3	DEF3	def3
4	GHI4	ghi4
5	JKL5	jkl5
6	MNO6	mno6
7	PQRS7	pqrs7
8	TUV8	tuv8
9	WXYZ9	wxyz9
*	* <SPACE>	* <SPACE>
#	#\@	#\@

French

KEY	UPPERCASE CHARACTERS	LOWERCASE CHARACTERS
0	0	0
1	1.;=_,'&()[]\$!	1.;=_,'&()[]\$!
2	ABC2ÂÂÇÁÁÆ	abc2ââçááæ
3	DEF3ÉÊËË	def3éèèè
4	GHI4ÏÏ	ghi4ïï
5	JKL5	jkl5
6	MNO6ÑÓÔÔÖ	mno6ñóóóö
7	PQRS7	pqrs7
8	TUV8	tuv8úúúú
9	WXYZ9	wxyz9
*	* <SPACE>	* <SPACE>
#	#\@	#\@

Spanish

KEY	UPPERCASE CHARACTERS	LOWERCASE CHARACTERS
0	0	0
1	1.;=,_'&()[]\$!	1.;=,_'&()[]\$!
2	ABC2ÁÂÇ	abc2áâç
3	DEF3ÉÈ	def3éè
4	GHI4Í	ghi4í
5	JKL5	jkl5
6	MNO6ÑÓÒ	mno6ñóò
7	PQRS7	pqrs7
8	TUV8ÚÛ	tuv8úû
9	WXYZ9	wxyz9
*	* <SPACE>	* <SPACE>
#	#^@	#^@

German

KEY	UPPERCASE CHARACTERS	LOWERCASE CHARACTERS
0	0	0
1	1.;=,_'&()[]\$!	1.;=,_'&()[]\$!
2	ABC2ÄÀ	abc2ääà
3	DEF3É	def3é
4	GHI4	ghi4
5	JKL5	jkl5
6	MNO6Ö	mno6ö
7	PQRS7ß	pqrs7ß
8	TUV8Ü	tuv8ü
9	WXYZ9	wxyz9
*	* <SPACE>	* <SPACE>
#	#^@	#^@

Italian

KEY	UPPERCASE CHARACTERS	LOWERCASE CHARACTERS
0	0	0
1	1.,;=,_'&()[]\$!	1.,;=,_'&()[]\$!
2	ABC2ÀÁÇ	abc2àáç
3	DEF3ÉÈË	def3éèë
4	GHI4	ghi4
5	JKL5	jkl5
6	MNO6ÓÒ	mno6óò
7	PQRS7	pqrs7
8	TUV8Ù	tuv8ù
9	WXYZ9	wxyz9
*	* <SPACE>	* <SPACE>
#	#\^@	#\^@

Portuguese

KEY	UPPERCASE CHARACTERS	LOWERCASE CHARACTERS
0	0	0
1	1.,;=,_'&()[]\$!	1.,;=,_'&()[]\$!
2	ABC2ÁÂÃÄÇ	abc2áâãäç
3	DEF3ÉÊ	def3éê
4	GHI4Í	ghi4í
5	JKL5	jkl5
6	MNO6ÓÔÕ	mno6óôõ
7	PQRS7	pqrs7
8	TUV8ÚÛ	tuv8úû
9	WXYZ9	wxyz9
*	* <SPACE>	* <SPACE>
#	#\^@	#\^@

Russian

KEY	UPPERCASE CHARACTERS	LOWERCASE CHARACTERS
0	0	0
1	1.;=,_'&()[]\$!	1.;=,_'&()[]\$!
2	АБВГ2ABC	абвг2abc
3	ДЕЁЖЭЗDEF	Деёжз3def
4	ИЙКЛ4GHI	ийкл4ghi
5	МНОП5JKL	мноп5jkl
6	РСТУ6MNO	рсту6mno
7	ФХЦЧ7PQRS7	фхчч7pqrs
8	ШЩЪЫІ8TUV	шщъыі8tuv
9	ЪЮЯ9WXYZ	ъюя9wxyz
*	* <SPACE>	* <SPACE>
#	#^@	#^@

Nordic

KEY	UPPERCASE CHARACTERS	LOWERCASE CHARACTERS
0	0	0
1	1.;=,_'&()[]\$!	1.;=,_'&()[]\$!
2	ABC2ÄÅÆÀ	abc2ääæà
3	DEF3É	def3é
4	GHI4	ghi4
5	JKL5	jkl5
6	MNO6ÖØ	mno6öø
7	PQRS7ß	pqrs7ß
8	TUV8Ü	tuv8ü
9	WXYZ9	wxyz9
*	* <SPACE>	* <SPACE>
#	#^@	#^@

Greek

KEY	UPPERCASE CHARACTERS	LOWERCASE CHARACTERS
0	0+	0+
1	1.;=,_'&()[]\$!	1.;=,_'&()[]\$!
2	ABC2ABΓ	abc2αβγ
3	DEF3ΔEZ	def3δεζ
4	GHI4HΘI	ghi4ηθι
5	JKL5KΛM	jkl5κλμ
6	MNO6NΞO	mno6νξο
7	PQRS7ΠΡΣ	pqrs7πρςσ
8	TUV8ΤΥΦ	tuv8τυφ
9	WXYZ9ΧΨΩ	wxyz9χψω
*	* <SPACE>	* <SPACE>
#	#\#@	#\#@

Specifying the Input Language Using the IP Phone UI

You can configure the language you use for input on the phone by setting the **Input Language** option. The default input language setting is English.

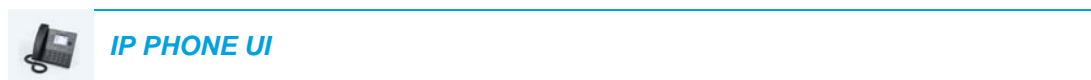

1. Press on the phone to enter the Options List.
2. Navigate to the **Language** option and press the button or **Select** softkey.
3. Press the key to highlight the **Input Language** option.

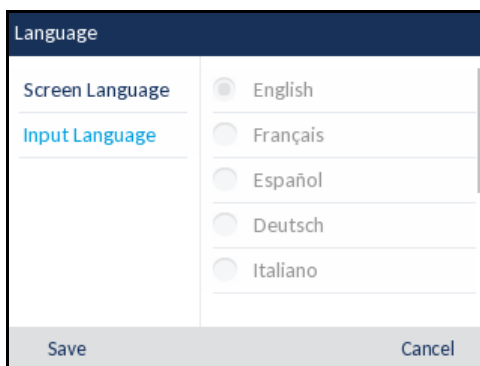

4. With **Input Language** highlighted press the key to move to selection column. Use the and keys to scroll through and choose the desired input language. Valid values are:
 - English (default)
 - Français (French)
 - Español (Spanish)

- Deutsch (German)
- Italiano (Italian)
- Português (Portuguese)
- Русский (Russian)
- Nordic
- ελληνικά (Greek)



Note: Available input languages are dependent on the configuration enabled by your System Administrator.

5. Press the **Save** softkey to save your changes.
The change is dynamic. The phone and the Mitel Web UI allow you to enter text and characters in the language you selected.

Specifying the Input Language Using the Mitel Web UI



MITEL WEB UI

1. Click on **Basic Settings > Preferences > Language Settings**.

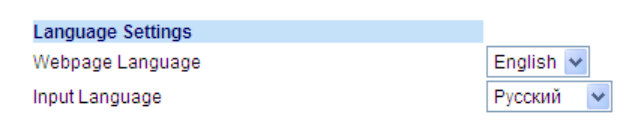

2. Select a language from the **Input Language** field. Setting this field allows you to specify the language to use when entering text and characters in the Mitel Web UI and IP phone UI. Valid values are:
 - English (default)
 - Français (French)
 - Español (Spanish)
 - Deutsch (German)
 - Italiano (Italian)
 - Português (Portuguese)
 - Русский (Russian)
 - Nordic
 - ελληνικά (Greek)



Note: All languages may not be available for selection. The available input languages are dependent on the configuration enabled by your System Administrator.

3. Click **Save Settings**.
The change is dynamic. The phone and the Mitel Web UI allow you to enter text and characters in the language you selected.

LATIN 2 CHARACTER SET

The 6867i includes support for ISO 8859-2 (Latin2) of multi-national languages when displaying and inputting in the IP phone UI and the Mitel Web UI. UTF-8 is also compatible with XML encoding on the IP phones.

The following table illustrates the Latin 2 character set used on the 6867i IP phone.

	-0	-1	-2	-3	-4	-5	-6	-7	-8	-9	-A	-B	-C	-D	-E	-F
A-	NBSP 00A0 160	Ą 0104 161	ˆ 02D8 162	Ł 0141 163	ł 00A4 164	Œ 013D 165	Š 015A 166	š 00A7 167	Ž 00A8 168	ž 0160 169	Ť 015E 170	ť 0164 171	Ž 0179 172	SHY 00AD 173	Ž 017D 174	Ž 017B 175
B-	° 00B0 176	ą 0105 177	ˆ 02DB 178	ł 0142 179	ł 00B4 180	Œ 013E 181	š 015B 182	ˆ 02C7 183	š 00B8 184	š 0161 185	ť 015F 186	ť 0165 187	ž 017A 188	ˆ 02DD 189	ž 017E 190	ž 017C 191
C-	Ŕ 0154 192	Á 00C1 193	Â 00C2 194	Ă 0102 195	Ă 00C4 196	Ĺ 0139 197	Ć 0106 198	Ç 00C7 199	Č 010C 200	É 00C9 201	Ę 0118 202	Ë 00CB 203	Ě 011A 204	Í 00CD 205	Î 00CE 206	Ď 010E 207
D-	Đ 0110 208	Ń 0143 209	Ň 0147 210	Ó 00D3 211	Ô 00D4 212	Õ 0150 213	Ö 00D6 214	× 00D7 215	Ř 0158 216	Ů 016E 217	Ú 00DA 218	Ů 0170 219	Û 00DC 220	Ý 00DD 221	Ŧ 0162 222	ß 00DF 223
E-	í 0155 224	á 00E1 225	â 00E2 226	ă 0103 227	ä 00E4 228	ĺ 013A 229	ć 0107 230	ç 00E7 231	č 010D 232	é 00E9 233	ę 0119 234	ë 00EB 235	ě 011B 236	í 00ED 237	î 00EE 238	ď 010F 239
F-	đ 0111 240	ń 0144 241	ň 0148 242	ó 00F3 243	ô 00F4 244	õ 0151 245	ö 00F6 246	÷ 00F7 247	ř 0159 248	ů 016F 249	ú 00FA 250	ű 0171 251	ü 00FC 252	ý 00FD 253	ŧ 0163 254	· 02D9 255

TIME AND DATE

On the IP phones, the following time and date sub-options are available to be configured:

- Settings:
 - Time Format
 - Daylight Savings
 - Date Format
- Time Zone
- Set Date and Time:
 - Use Network Time (configure time servers)
 - Enter Time and Date





Note: All time and date settings can be configured using the IP phone UI. Time/Date Formats and Time Servers are the only two time and date settings that can be configured using the Mitel Web UI.

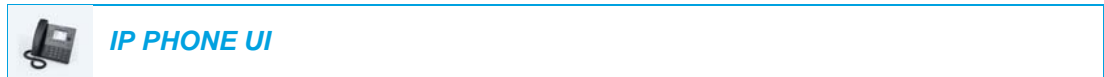

SETTINGS

Configuring the Time Format, Daylight Savings, and Date Format Using the IP Phone UI

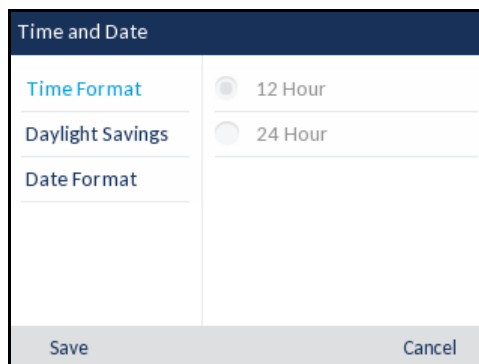

1. Press  on the phone to enter the Options List.
2. Navigate to the **Time and Date > Settings** option and press the  button or **Select** softkey.



3. With **Time Format** highlighted press the  key to move to selection column.
4. Use the  and  keys to scroll through and choose the desired time format. Valid values are 12 Hour and 24 Hour (the default is 12 Hour).

5. Press the ◀ key to move to back to the options column and press the ▲ key to highlight **Daylight Savings**.

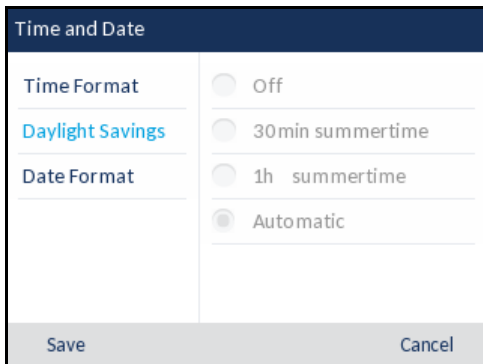

6. With **Daylight Savings** highlighted press the ▶ key to move to selection column.
7. Use the ▲ and ▼ keys to scroll through and choose the desired daylight savings setting. Valid values are:
- Off
 - 30 min summertime
 - 1h summertime
 - Automatic (default)
8. Press the ◀ key to move to back to the options column and press the ▲ key to highlight **Date Format**.

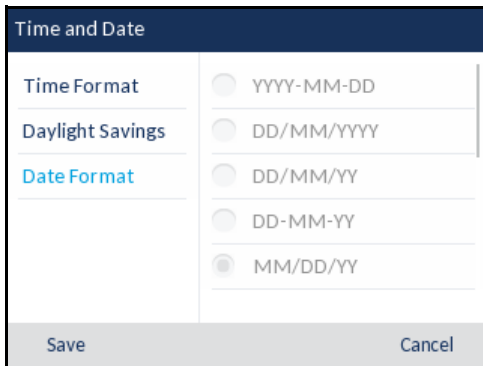

9. With **Date Format** highlighted press the ▶ key to move to selection column.
10. Use the ▲ and ▼ keys to scroll through and choose the desired date format. Valid values are:
- WWW MMM DD (default)
 - DD-MMM-YY
 - YYYY-MM-DD
 - DD/MM/YYYY
 - DD/MM/YY
 - DD-MM-YY
 - MM/DD/YY

- MMM DD
- DD MMM YYYY
- WWW DD MMM
- DD MMM
- DD.MM.YYYY

11. Press the **Save** softkey to save your changes.





Note: The time and date formats you configure are applicable to the **Home** screen as well as the Received Callers and Outgoing Redial Lists.

TIME ZONE

Configuring the Time Zone Using the IP Phone UI





IP PHONE UI

1. Press  on the phone to enter the Options List.
2. Navigate to the **Time and Date > Time Zone** option and press the  button or **Select** softkey.

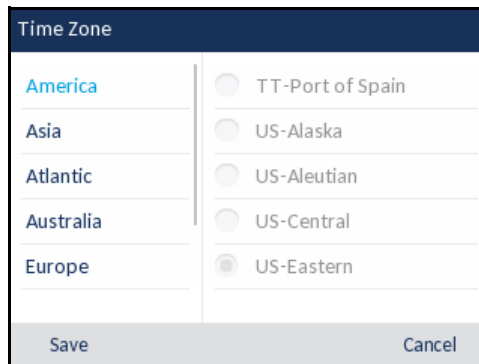
A list of time zones displays for different areas of the world.



3. Use the  and  keys to scroll through and highlight the desired region. Valid values are:
 - America
 - Asia
 - Atlantic
 - Australia
 - Europe
 - Pacific
 - Others
4. With the desired region highlighted press the  key to move to selection column.

5. Use the ▲ and ▼ keys to scroll through and choose the time zone that applies to your area. The default time zone is US-Eastern.



Note: For a list of the time zone values available on the IP phone, see [“Appendix A - Time Zone Codes.”](#)



6. Press the **Save** softkey to save your changes.

SET DATE AND TIME

Configuring the Date and Time Using the IP Phone UI

With a valid time server enabled your IP phone will synchronize the time displayed with the specified configuration server. The phone will use the time from Time Server 1 unless it is not configured or unavailable, in which case it will move on to Time Server 2, and if necessary Time Server 3.



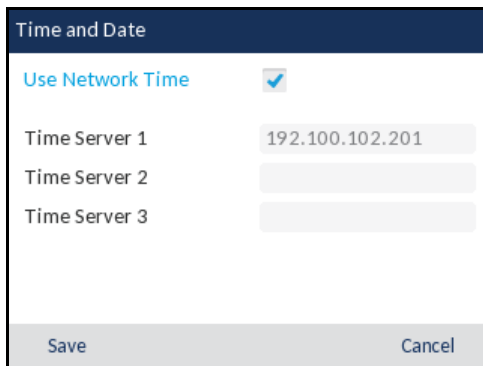

1. Press  on the phone to enter the Options List.
2. Navigate to the **Time and Date > Set Date and Time** option and press the  button or **Select** softkey.
3. If you want to synchronize the time and date using a time server, ensure there is a checkmark in the box corresponding to the **Use Network Time** setting. If there is no checkmark, press the  button to enable the **Use Network Time** setting.

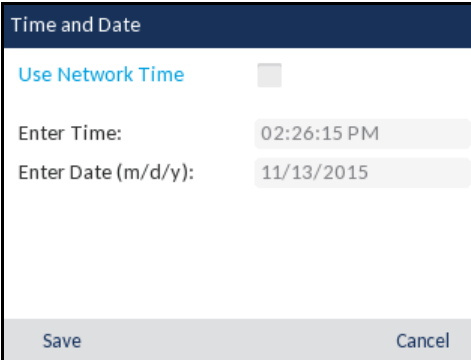

- a. Press the ▲ key to highlight **Time Server 1**, **Time Server 2**, or **Time Server 3**.
- b. Using the keys on the dialpad, enter an IP address or domain name for the time server. Use the **Backspace** key to move back a space and delete a character. Use the **Dot** softkey to enter dots within the IP address or domain name. Use the **123 4** softkey to toggle between entering numbers and entering letters.

4. If you want to manually set the date and time, press the  button to clear the checkmark from the **Use Network Time** box and disable the setting.



- a. Press the  key to highlight **Enter Time** or **Enter Date**.
 - b. Using the keys on the dialpad, change the time and date accordingly.
When entering the time, use the **AM/PM** softkey to toggle between AM and PM.
5. Press the **Save** softkey to save your changes.

Configuring Time and Date Settings Using the Mitel Web UI



1. Click on **Basic Settings > Preferences > Time and Date Setting**.



2. In the **Time Format** field, select the time format you want to use on your phone. Valid values are:
 - 12h (12 hour format) (default)
 - 24h (24 hour format)



Note: The time format you configure is applicable to the phone's **Home** screen as well as the Received Callers and Outgoing Redial Lists.

3. In the **Date Format** field, select the date format you want to use on your phone. Valid values are:
 - WWW MMM DD (default)
 - DD-MMM-YY
 - YYYY-MM-DD

- DD/MM/YYYY
- DD/MM/YY
- DD-MM-YY
- MM/DD/YY
- MMM DD
- DD MMM YYYY
- WWW DD MMM
- DD MMM
- DD.MM.YYYY



Note: The date format you configure is applicable to the phone's **Home** screen as well as the Received Callers and Outgoing Redial Lists.

4. In the **NTP Time Servers** field, enable the setting by checking the box or disable the setting by unchecking the box (default is enabled).
5. In the **Time Server 1**, **Time Server 2**, and **Time Server 3** fields, enter IP addresses or qualified domain names for the primary, secondary, and tertiary time servers.



Note: Time servers can only be entered if **NTP Time Servers** is enabled.

6. Click **Save Settings**.

DIRECTORY

You can configure directory entries to display using the contact's first name and then last name or vice versa. Moreover, the option to sort contacts using either their first name or last name is available through the *Directory > Settings* options menu.



Note: If you have a K680i Keyboard attached to the phone, the *Directory > Settings* options menu also allows you to enable/disable the Live Keyboard feature.

If external Directory sources are configured, you can enable/disable the respective Directory sources as well as rename Directory folder labels through the *Directory > External Sources* options menu.





Note: For more information on Directory functionality, see "Directory" on page clxii.

SETTINGS



Configuring Directory Display and Sorting Options Using the IP Phone UI

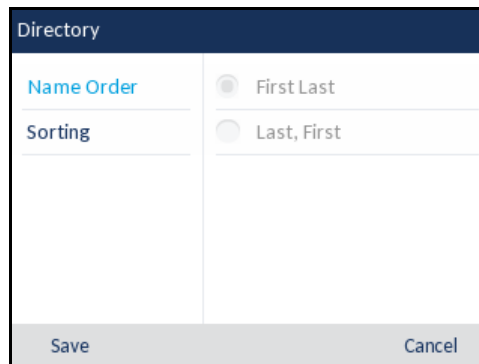

IP PHONE UI

1. Press  on the phone to enter the Options List.
2. Navigate to the **Directory > Settings** option and press the  button or **Select** softkey.



3. With **Display Name Order** highlighted press the  key to move to selection column.
4. Use the  and  keys to and choose the desired display name order.

5. Press the key to move to back to the options column and press the key to highlight **Sorting Preferences**.

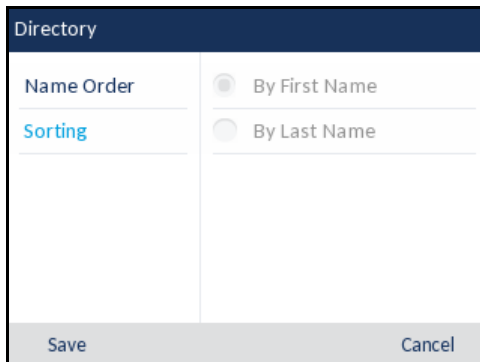

6. With **Sorting Preferences** highlighted press the key to move to selection column.
7. Use the and keys to and choose the desired sorting preference.
8. Press the **Save** softkey to save your changes.

Enabling/Disabling Live Keyboard



Note: This setting is only available if a K680i keyboard is attached to the phone.

When the phone is in an idle state and a alphabetic character key on an attached K680i keyboard is pressed, the default behavior of the phone is to simply wake up (if the phone is dimmed or displaying the screensaver). Users have the option to enable the Live Keyboard feature, which, in addition to waking up the phone (if applicable), will launch the Directory search function in such scenarios.

IP PHONE UI

1. Press on the phone to enter the Options List.
2. Navigate to the **Directory > Settings** option and press the button or **Select** softkey.
3. Use the key to scroll down and highlight the **Live Keyboard** setting.

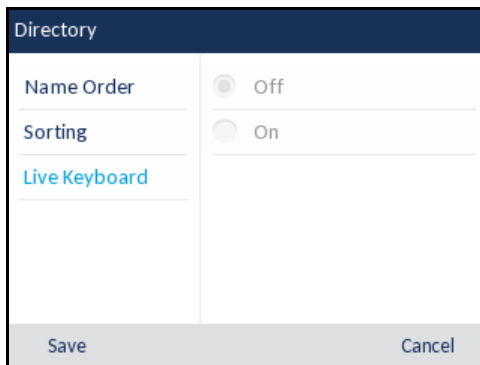

4. Press to move to the selection column.
5. Use and keys to enable (On) or disable (Off) the Live Keyboard feature.

6. Press the **Save** softkey to save your changes.

EXTERNAL SOURCES



Note: Menu available only if external Directory sources have been configured by your Administrator.

Enabling/Disabling Directories and Renaming Labels Using the IP Phone UI



IP PHONE UI

1. Press on the phone to enter the Options List.
2. Navigate to the **Directory > External Sources** option and press the button or **Select** softkey.
3. Use the and keys to navigate through the list of Directory sources and press the button to enable or disable each one as per your preference.

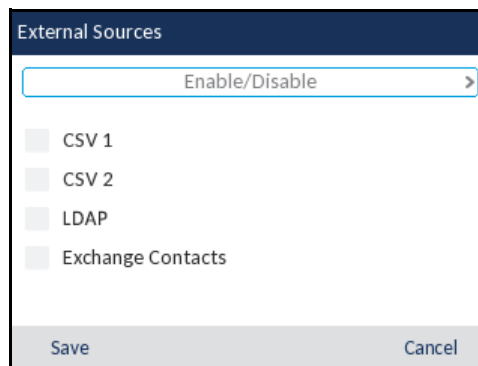

Note: CSV 1 and 2 are enabled by default. All other Directory sources are disabled by default.

4. Press the key to navigate to the **Enable/Disable** tab, and press the key to switch to the **Labels** tab.

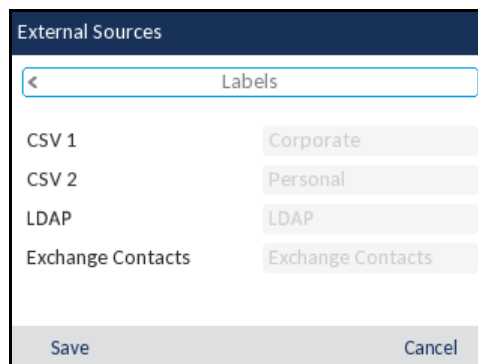

5. Use the and keys to navigate through the list of Directory source labels and using the dialpad keys enter in a name for the respective directory folders.
6. Press the **Save** softkey to save your changes.

CREDENTIALS





Note: Menu available only if certain features requiring authentication to a server have been configured by your Administrator.

Some features (e.g. LDAP Directory, Microsoft Exchange Directory, BroadSoft Xsi features, etc...) require authentication to external servers before they can be used. The **Credentials** options menu allows you to enter in your user credentials for these respective features. This menu also allows users to test their authentication settings and connection to the respective server/source.



ENTERING USERNAMES/PASSWORDS AND CONNECTION TESTING USING THE IP PHONE UI

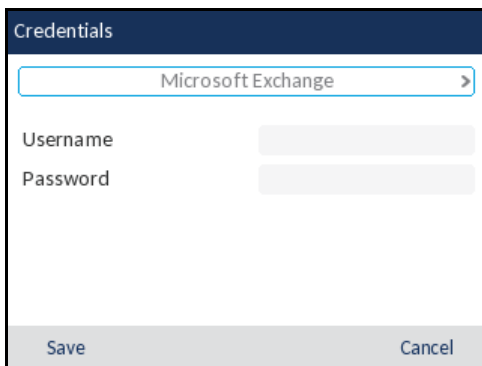

IP PHONE UI

1. Press  on the phone to enter the Options List.
2. Navigate to the **Credentials** option and press the  button or **Select** softkey.
3. Use the left and right keys to navigate to the desired feature tab (e.g. LDAP, Microsoft Exchange, BroadSoft Xsi).



4. Press the  key to highlight the **Username** field and using the dialpad keys enter in the username applicable to the Directory source.
5. Press the  key to highlight the **Password** field and using the dialpad keys enter in the password applicable to the Directory source.
6. Press the  key to navigate to the respective feature tab and repeat Steps 3 to 5 for any other features you want to configure.

- Press the **▼** key to navigate to the respective feature tab, and press the **▶** key to until you get to the **Test Connection** tab.

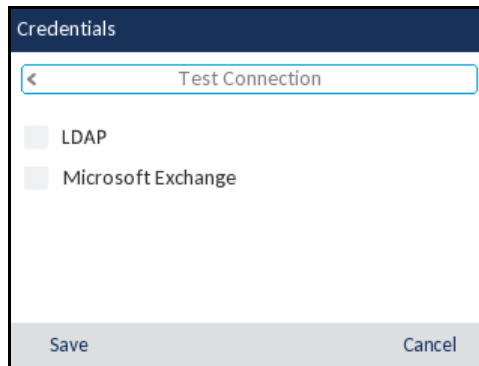

- Press the **▲** key to highlight the respective feature and press the button to enable authentication/connection testing on that feature.
- Repeat Step 8 for all features you want to test.
- Press the **Test** softkey to begin testing.
A green **✓** will appear if there are no issues with the authentication/connection to the external source.
A red **!** will appear if issues are found.
If there are issues with your connection, please check your username and password for any errors.
- Press the **Save** softkey to save your changes.

CALL FORWARD



Note: For Call Forward information and configuration details, see [“Call Forward Configuration”](#) on page clxxxviii.

LOCK

PASSWORD

This category allows you to change the user password for your phone. Changing your password ensures that only you can alter your phone settings and helps keep your system secure. You can change your user password using the IP phone UI or the Mitel Web UI.





Note: Valid values when creating or changing a password are 0 to 4294967295 (integers only; symbols and alpha characters are not allowed). The default password is an empty string (i.e. leave the field blank).

Setting a User Password Using the IP Phone UI



IP PHONE UI

1. Press  on the phone to enter the Options List.
2. Navigate to the **Lock > Password** option and press the  button or **Select** softkey.

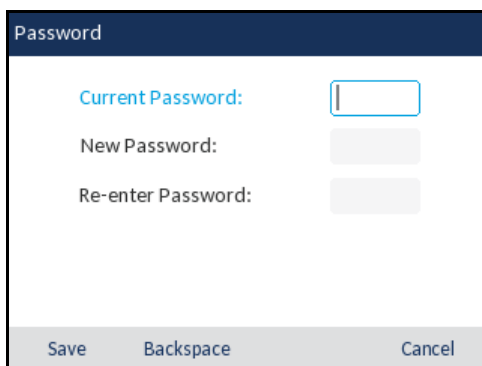

3. In the **Current Password:** field, enter the current user password.
4. In the **New Password:** field, enter the new user password.
5. In the **Re-enter Password:** field, re-enter the new user password.
6. Press the **Save** softkey to save your changes.
A **Password Changed** confirmation message displays on the screen.

PHONE LOCK

You can lock your phone to prevent the phone from being used or configured. You can lock the phone using the IP phone UI, Mitel Web UI or by configuring a Lock softkey on your phone. For more information about configuring a Lock/Unlock key on your phone, see [“Phone Lock Key”](#) on [page cxxx](#).

Locking the Phone Using the IP Phone UI



IP PHONE UI

1. Press  on the phone to enter the Options List.

2. Navigate to the **Lock > Phone Lock** option and press the  button or **Select** softkey.

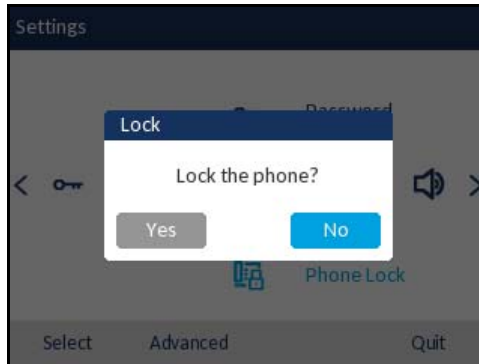



3. At the **Lock the phone?** prompt, navigate to the **Yes** button and press the  button. The message **Phone is locked** and lock icon displays on the **Home** screen. Additionally the Message Waiting Indicator (MWI) will turn on.



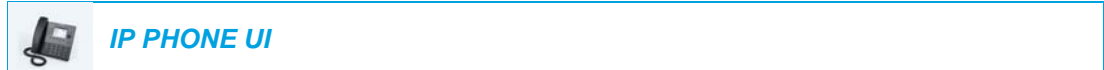

Note: Alternatively, if configured, you can lock the phone by simply pressing a **Lock** softkey.

Unlocking the Phone Using the IP Phone UI

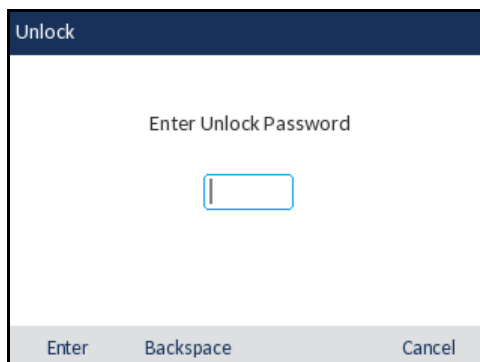

1. Press  on the phone to enter the Options List (or press a configured **Unlock** softkey).



2. At the **Enter Unlock Password** prompt, enter your user password and press the **Enter** softkey or  button.
3. At the **Unlock the phone?** prompt, navigate to the **Yes** button and press the  button.

CONFIGURING LOCK SETTINGS USING THE MITEL WEB UI

Setting a User Password

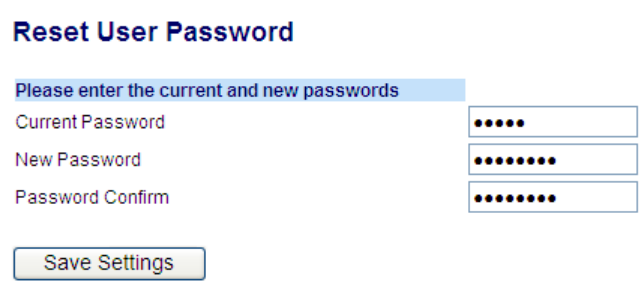

1. Click on **Operation > User Password**.

 A screenshot of a web form titled "Reset User Password". The form has a blue header with the text "Please enter the current and new passwords". Below the header are three input fields: "Current Password" with five dots, "New Password" with seven dots, and "Password Confirm" with seven dots. At the bottom of the form is a "Save Settings" button.

2. In the **Current Password** field, enter the current user password.
 **Note:** By default, the user name is user (all lowercase) and the password field is left blank.
3. In the **New Password** field, enter the new user password.
4. In the **Password Confirm** field, enter the new user password again.
5. Click **Save Settings**.

Resetting a User Password

If you forget your password, you can reset it and enter a new password. The reset user password feature resets the password to the factory default which is blank (no password). You can reset a user password using the Mitel Web UI only.



Note: Valid values when creating or changing a password are 0 to 4294967295 (integers only; symbols and alpha characters are not allowed). The default password is an empty string (i.e. leave the field blank).

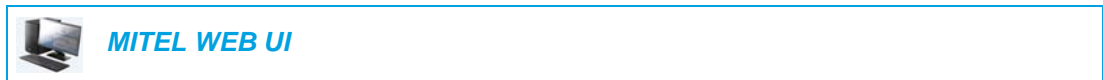

1. Click on **Operation > Phone Lock**.

2. In the **Reset User Password** field, click **Reset**.
The following screen displays.

3. In the **Current Password** field, leave this blank.
4. In the **New Password** field, enter a new password.
5. In the **Password Confirm** field, re-enter your new user password.
6. Click **Save Settings**.

Locking and Unlocking the Phone



1. Click on **Operation > Phone Lock**.



To Lock the Phone

2. In the **Lock the Phone?** field, click **Lock**.
The message **Phone is locked** and lock icon displays on the **Home** screen. Additionally the Message Waiting Indicator (MWI) will turn on.

Unlocking the Phone





3. Click on **Operation > Phone Lock**.
4. In the **Unlock the Phone?** field, click **Unlock**.

AUDIO

The **Audio** option on the IP phone allows you to set the audio mode for your IP phone, configure headset settings, and personalize ring tones and tone sets.



AUDIO MODE

The 6867i allows you to use a handset, a headset, or handsfree mode to handle incoming and outgoing calls. The **Audio Mode** option provides different combinations of these three methods to provide maximum flexibility in handling calls. There are four audio mode options you can set:

AUDIO MODE OPTION	DESCRIPTION
Speaker	This is the default setting. Calls can be made or received using the handset or handsfree speakerphone. In handset audio mode, pressing the  button on the phone switches to handsfree speakerphone. In Speaker audio mode, lift the handset to switch to the handset.
Headset	Choose this setting if you want to make or receive all calls using a handset or headset. Calls can be switched from the handset to headset by pressing the  button on the phone. To switch from the headset to the handset, lift the handset.
Speaker/Headset	Incoming calls are sent to the handsfree speakerphone first when the  button is pressed. By pressing the button again, you can switch back and forth between the handsfree speakerphone and the headset. At anytime, lifting the handset switches back to the handset from either the handsfree speakerphone or the headset.
Headset/Speaker	Incoming calls are sent to the headset first when the  button is pressed. By pressing the button again, you can switch back and forth between the headset and the handsfree speakerphone. At anytime, lifting the handset switches back to the handset from either the headset or the handsfree speakerphone.

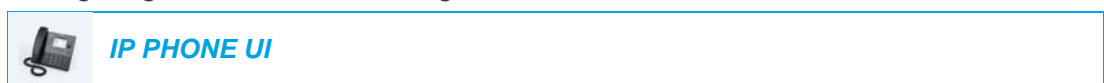
Configuring the Audio Mode Using the IP Phone UI



1. Press  on the phone to enter the Options List.
2. Navigate to the **Audio > Audio Mode** option and press the  button or **Select** softkey.

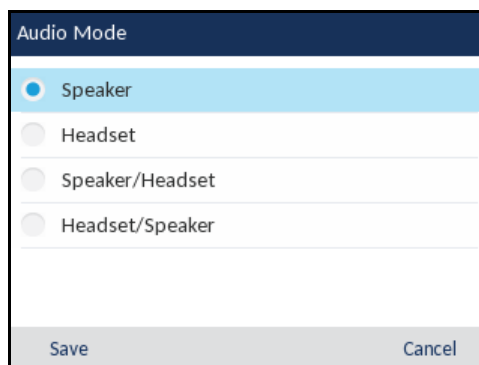



- Use the ▲ and ▼ keys to scroll through and highlight the desired audio mode. Valid values are:
 - Speaker (default)
 - Headset
 - Speaker/Headset
 - Headset/Speaker
- Press the **Save** softkey to save your changes.

HEADSET

The **Headset** option allows you to set the volume level for the headset microphone and also allows you to enable/disable DHSG.

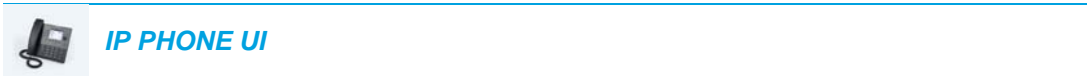
Configuring Headset Mic Volume and DHSG Using the IP Phone UI



- Press  on the phone to enter the Options List.
- Navigate to the **Audio > Headset** option and press the  button or **Select** softkey.

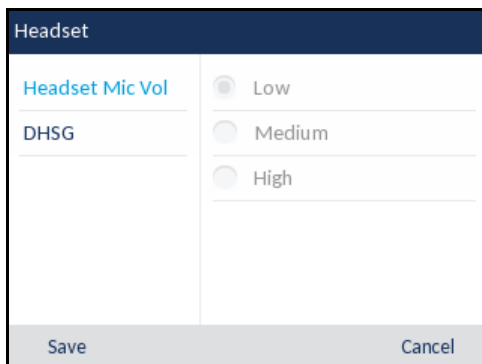

- With **Headset Mic Vol** highlighted press the ► key to move to selection column.
- Use the ▲ and ▼ keys to scroll through and choose the desired volume setting. Valid values are:
 - Low
 - Medium (default)
 - High

5. Press the ◀ key to move to back to the options column and press the ▲ key to highlight **DHSG**.

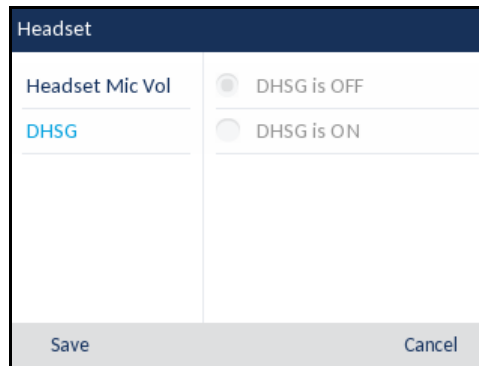

6. With **DHSG** highlighted press the ▶ key to move to selection column.
7. Use the ▲ and ▼ keys to scroll through and choose whether or not to enable DHSG. Valid values are:
 - DHSG is OFF (default)
 - DHSG is ON
8. Press the **Save** softkey to save your changes.

RING TONES AND TONE SETS

There are several distinct ring tones a user can select to set on the IP phones. In addition to the 15 pre-installed ringtones, custom ring tones can be manually installed through the Web UI and selected for use (if enabled by your Administrator). You can enable/disable these ring tones on a global or per-line basis.



Note: Individual contact ring tones are also supported on the 6867i. Individual contact ring tones can be used during incoming calls to help users identify the party calling. For more information on individual contact ring tones, see [“Local Directory Features”](#) on page clxvii.

The following table identifies the valid settings and default values for each type of configuration method.

Ring Tones

CONFIGURATION METHOD	VALID VALUES	DEFAULT VALUE
IP Phone UI	Global Tone 1 to 15 Silent Custom Ring Tone 1 to 8 (if available)	Global Setting: Tone 1
Mitel Web UI	Global: Tone 1 to 15 Silent Custom Ring Tone 1 to 8 (if available)	Global Setting: Tone 1
Lines 1 to 24	Per-Line Setting: Global Tone 1 to 15 Silent Custom Ring Tone 1 to 8 (if available)	Per-Line Setting: Global

In addition to ring tones, you can configure ring tone sets on a global-basis on the IP phone. Ring tone sets consist of tones customized for a specific country. The ring tone sets you can configure on the IP phones are:

- Australia
- Brazil
- Canada
- Europe (generic tones)
- France
- Germany
- Italy
- Italy2
- Malaysia
- Mexico
- Russia
- Slovakia
- UK
- US (Default)

When you configure the country's tone set, the country-specific tone is heard on the phone for the following:

- Dial tone



- Secondary dial tone
- Ring tone
- Busy tone
- Congestion tones
- Call waiting tone
- Ring cadence pattern

You configure global ring tones and tone sets using the IP phone UI and Mitel Web UI. Installing a custom ring tone can be performed using the Mitel Web UI only.

Configuring Ring Tones Using the IP Phone UI



Global configuration only

1. Press  on the phone to enter the Options List.
2. Navigate to the **Audio > Ring Tones** option and press the  button or **Select** softkey.



3. Use the **▲ and ▼** keys to scroll through and choose the desired ring tone (**Tone 1** through **Tone 15**, **Silent**, or any custom ring tones installed).
4. Press the **Save** softkey to save your changes.
The ring tone you select is immediately applied to the IP phone.

Configuring Tone Sets Using the IP Phone UI

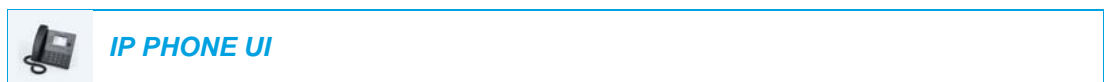



Global configuration only

1. Press  on the phone to enter the Options List.

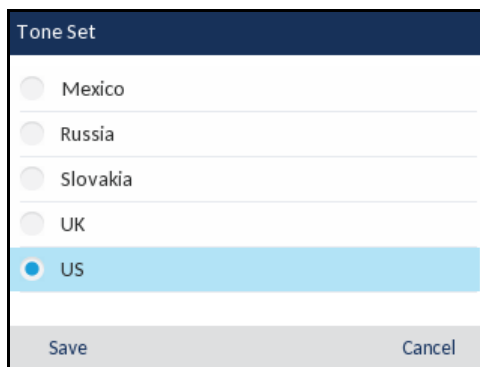
2. Navigate to the **Audio > Tone Sets** option and press the  button or **Select** softkey.



3. Use the  and  keys to scroll through and choose the desired tone set. Valid values are:
- Australia
 - Brazil
 - Canada
 - Europe
 - France
 - Germany
 - Italy
 - Italy2
 - Malaysia
 - Mexico
 - Brazil
 - Russia
 - Slovakia
 - UK
 - US (default)
4. Press the **Save** softkey to save your changes.
The tone set you select is immediately applied to the IP phone.

Configuring Ring Tones and Tone Sets Using the Mitel Web UI

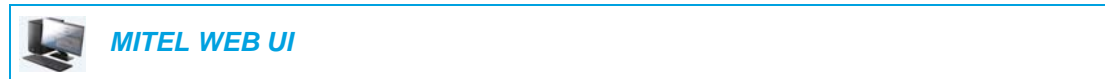

1. Click on **Basic Settings > Preferences > Ring Tones**.

Ring Tones	
Tone Set	US
Global Ring Tone	Tone 1
Line 1	Global
Line 2	Global
Line 3	Global
Line 4	Global
Line 5	Global
Line 6	Global
Line 7	Global
Line 8	Global
Line 9	Global

For global configuration

2. In the **Ring Tones** section, select a country from the **Tone Set** field. Valid values are:

- Australia
- Brazil
- Canada
- Europe
- France
- Germany
- Italy
- Italy2
- Malaysia
- Mexico
- Brazil
- Russia
- Slovakia
- UK
- US (default)

3. Select a value from the **Global Ring Tone** field.



Note: See the “Ring Tones” on [page lxvi](#) for valid values.

For per-line configuration

4. In the **Ring Tone** section, select a line for which you want to set ring tone.

5. Select a value from the **Line N** field.



Note: See the “Ring Tones” on [page lxxvi](#) for valid values.

6. Click **Save Settings**.

Installing Custom Ring Tones Using the Mitel Web UI

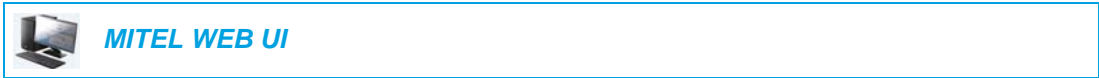

1. Click on **Basic Settings > Custom Ringtones**



2. Press the **Browse...** button corresponding to the desired ringtone position (e.g. 1).
3. Navigate to the folder containing the WAV file you want to upload, select the file using your left mouse button, and press the **Open** button.
The filename should now be displayed to the right of the respective **Browse...** button.
4. Press the **Upload** button to upload the file to the phone.



Note: Press the **Delete** button to delete the desired ringtone from your phone.

5. Repeat Steps 2 to 4 to upload additional WAV files to the phone.



Notes:

1. Access to the Custom Ringtones Web UI menu is only available if enabled by your System Administrator. Ringtones must be in .wav format. The IP phones support the following WAV file specifications:
 - G.711 μ -law and a-law Codec
 - 20 ms packet size
 - Mono 8KHz
2. Individual WAV files cannot exceed 1 MB in size (the total combined size of the eight WAV files cannot exceed 8 MB).
3. Filenames must contain only ASCII characters.

DISPLAY

The **Display** option allows you to set the following on your phone:

- Home Screen Settings:
 - Home Screen Mode
 - Screen Saver Timer
- Brightness Settings:
 - Brightness Level
 - Brightness Timer

HOME SCREEN SETTINGS

The **Home Screen Mode** option on the IP phone allows you to select how your home screen is displayed. The 6867i IP phone contains two home screen layout options. The default primary home screen mode provides users with a larger date and time and displays the screen name (if configured) beside the line number in the top status bar. The secondary home screen mode displays both screen name and screen name 2 (if configured) and are displayed above the smaller, repositioned date and time.

Home Screen Mode 1



Home Screen Mode 2



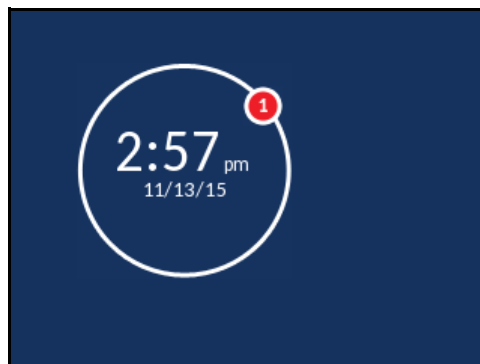

The **Screen Saver Timer** option allows you to configure the amount of time (in seconds) the phone must be idle before the screen saver initiates. When the specified amount of time expires, a screen saver displaying the date and time and the number of missed calls (if applicable) is displayed on screen.

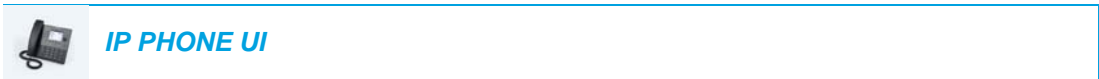

Configuring the Home Screen Mode and Screen Saver Timer



1. Press  on the phone to enter the Options List.
2. Navigate to the **Display** option and press the  button or **Select** softkey.

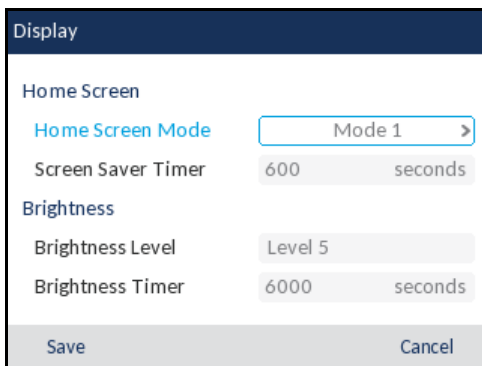

3. Use the left and right navigation buttons to change the desired home screen mode.
4. Press the  key to highlight **Screen Saver Timer**.
5. Enter a value, in seconds, using the dialpad keys. You can set the timer from 0 (disabled) to 7200 seconds. Default is 1800 (30 minutes).
6. Press the **Save** softkey to save your changes.

BRIGHTNESS SETTINGS

The **Brightness Level** option on the IP phone allows you to set the amount of light that illuminates the LCD display. Use this option to set the preference of brightness level.

The **Brightness Timer** option allows you to set the amount of time you want the LCD display to stay illuminated before turning the backlight off during a period of inactivity. For example, if you set the brightness timer to 60, when the phone reaches 60 seconds of inactivity, the LCD backlight goes off.





Note: The Backlight timer/mode can be configured using the configuration files and the IP Phone User Interface (UI).



Setting the Brightness Level and Timer Using the IP Phone UI

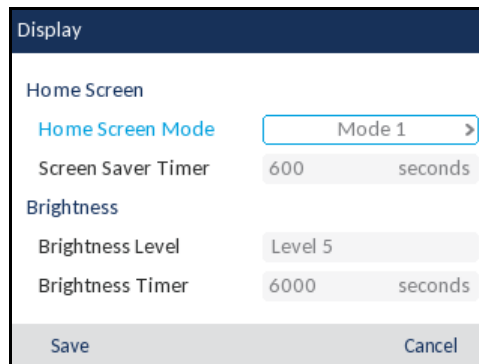

IP PHONE UI

1. Press  on the phone to enter the Options List.
2. Navigate to the **Display** option and press the  button or **Select** softkey.



3. Press the  key twice to highlight **Brightness Level**.
4. Use the left and right navigation buttons to increase or decrease the intensity of brightness on the LCD.
5. Press the  key to highlight **Brightness Timer**.
6. Enter a value, in seconds, using the dialpad keys. You can set the timer from 1 to 36000 seconds. Default is 600 (10 minutes).
7. Press the **Save** softkey to save your changes.

DIALING

LIVE DIALPAD

The **Live Dialpad** option on the IP phone turns the live dialpad mode on or off. With the live dialpad feature enabled, the 6867i IP phone automatically dials out and turns on handsfree mode as soon as a dialpad key or softkey is pressed. With live dialpad disabled, if you dial a number while the phone is on-hook, lifting the receiver or pressing the  initiates a call to that number.





Note: Availability of this feature is dependent on your phone system or service provider.

You can enable/disable the live dialpad using the IP phone UI only.

Enabling/Disabling Live Dialpad Using the IP Phone UI



1. Press  on the phone to enter the Options List.
2. Navigate to the **Dialing > Live Dialpad** option and press the  button or **Select** softkey.

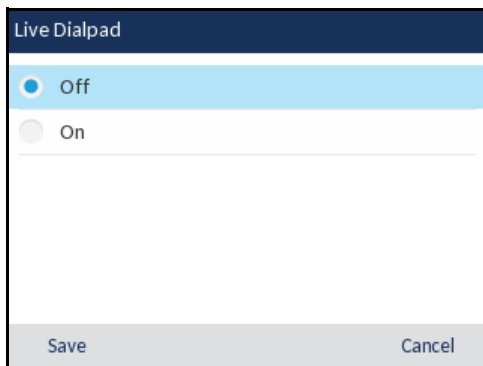

3. Use the **▲** and **▼** keys to scroll through and enable (**On**) or disable (**Off**) the live dialpad feature.
4. Press the **Save** softkey to save your changes.

SPEED DIAL EDIT





Note: For details on speed dial configuration, see “[Speed Dial Key](#)” on [page lxxxvii](#).

RESTART

You may want to restart your phone to check for updates on the server or you may occasionally need to restart your phone for configuration changes to your phone or network settings to take effect. You may also need to restart your phone if you have been asked to do so by your System Administrator or should you experience any unexpected behavior.

RESTARTING YOUR PHONE USING THE IP PHONE UI



1. Press the  button on the phone to enter the Options List.
2. Navigate to the **Restart** option and press the  button or **Select** softkey.

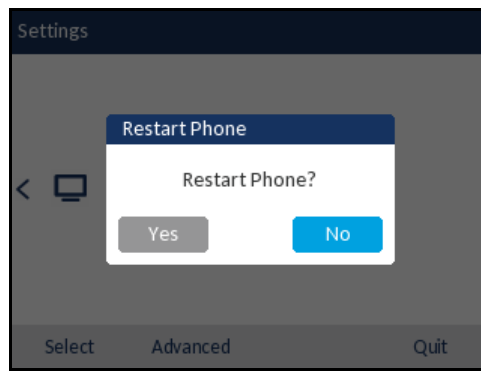

3. When the prompt, **Restart Phone?** appears, navigate to the **Yes** button and press the  button.
If you do not wish to restart your phone, press **Cancel** or **No**.



Note: Your phone is out of service temporarily during the restart and reboot process.

Restarting Your Phone Using the Mitel Web UI



1. Click on **Operation > Reset**.



2. Click **Restart**.
3. Click **OK** at the confirmation prompt.

EMERGENCY DIAL PLAN

Public telephone networks in countries around the world have a single emergency telephone number (emergency services number), that allows a caller to contact local emergency services for assistance when required. The emergency telephone number may differ from country to country. It is typically a three-digit number so that it can be easily remembered and dialed quickly. Some countries have a different emergency number for each of the different emergency services.

You can specify the digits to dial on the IP phone for contacting emergency services. Once you specify the emergency number(s) on the phone, you can dial those numbers directly on the dialpad when required and the phone automatically dials to those emergency services.

You can set the emergency dial plan using the Mitel Web UI only.



Notes:

1. Emergency dial plan pattern matching is only functional when the live dialpad feature is enabled. For more information on the live dialpad feature, see [“Live Dialpad”](#) on page lxxiv.
2. Contact your local phone service provider for available emergency numbers in your area.

The following table describes the default emergency numbers on the IP phones.

EMERGENCY NUMBER	DESCRIPTION
911	A United States emergency number.
999	A United Kingdom emergency number.
112	An international emergency telephone number for GSM mobile phone networks. In all European Union countries it is also the emergency telephone number for both mobile and fixed-line telephones.
110	A police and/or fire emergency number in Asia, Europe, Middle East, and South America.

Defining an Emergency Dial Plan Using the Mitel Web UI



1. Click on **Operation > Phone Lock**.

Phone Lock

Lock or unlock the phone

Emergency Dial Plan

Lock the phone?

Reset User Password

2. In the **Emergency Dial Plan** field, enter the 3-digit number used in your local area to contact emergency services. For multiple numbers, enter a | between each emergency number. For example:
911|110
 Default for this field is **911|999|112|110**.
3. Click **Save Settings** to save the emergency dial plan to your phone.

LINE AND CALL APPEARANCES

The 6867i has 2 hard line/call appearance buttons each with a corresponding status light.

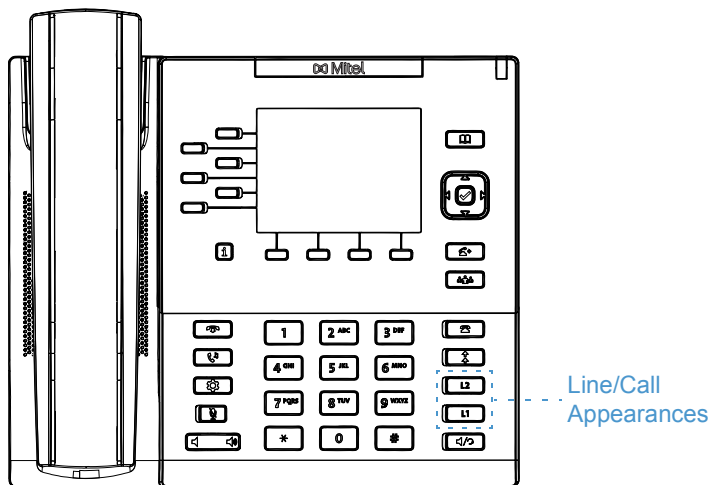

These line/call appearance buttons and lights can represent physical lines, calls for your extension, or calls from a group that your extension is part of. By pressing a line/call appearance button, you connect to the line or a call it represents. The line/call appearance light indicates the status of that line or call. When the phone is taken off-hook, the phone automatically selects a line for you.

LINE/CALL APPEARANCE LED BEHAVIOR

LINE/CALL APPEARANCE STATUS

Off	Idle line or no call activity
Light flashes quickly	Ringing
Light is solid	Connected
Light flashes slowly	Hold

When you have more than one call, you can use the ▲ and ▼ navigation keys to scroll up and down to view information for the different calls. The display shows which line the call information is referring to (L1, L2, L3, L4, etc.), picture ID and Caller ID information (name and number) if available, the call status (connected, ringing, held call, etc...), and the timer specific to that call.

PRESENCE KEY

The **Presence**  key is used to access the contact information screens, which provide detailed information about a respective Busy Lamp Field (BLF) or Speed Dial contact.

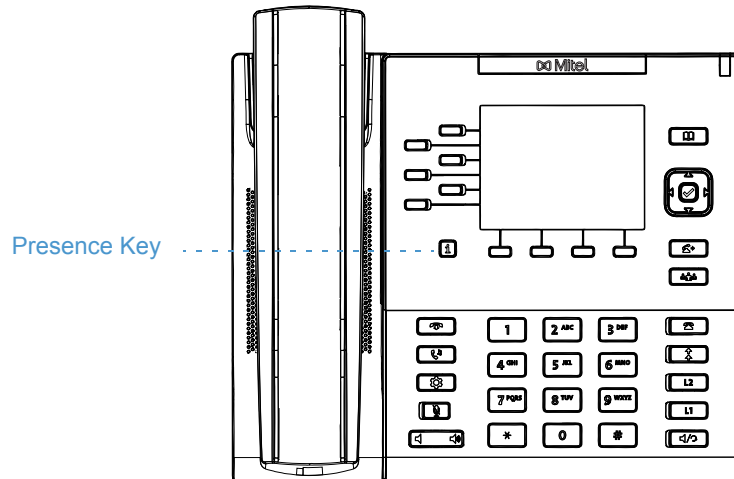

When you press the  key, you are able to view the contact's BLF details (if a BLF key is selected), Picture ID (if applicable), as well as all the phone numbers of the contact saved in your phone's memory.





USING THE PRESENCE KEY

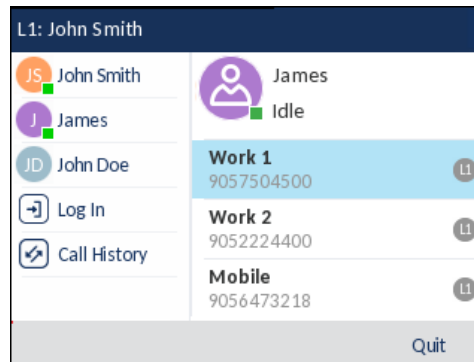

1. While on the **Home** Screen, press the  key.
2. Press a left softkey that is configured with BLF or Speed Dial functionality. The contact information screen will be displayed.



Note: To switch to another contact, simply press the desired BLF or Speed Dial softkey.

3. Press the  button to place a call using the contact's default phone number. If you would like to place a call to a different phone number attached to the contact (if applicable), highlight the desired phone number using the  and  navigation keys, and press the  key.
4. Press  or the **Quit** softkey at any time to exit.

CONFIGURING SOFTKEYS

Your 6867i has 6 multi-functional left softkeys and 4 multi-functional bottom softkeys:

- 6 left softkeys: programmable non-state-based softkeys (up to 20 programmable functions)
- 4 bottom softkeys: programmable state-based softkeys (up to 18 programmable functions)

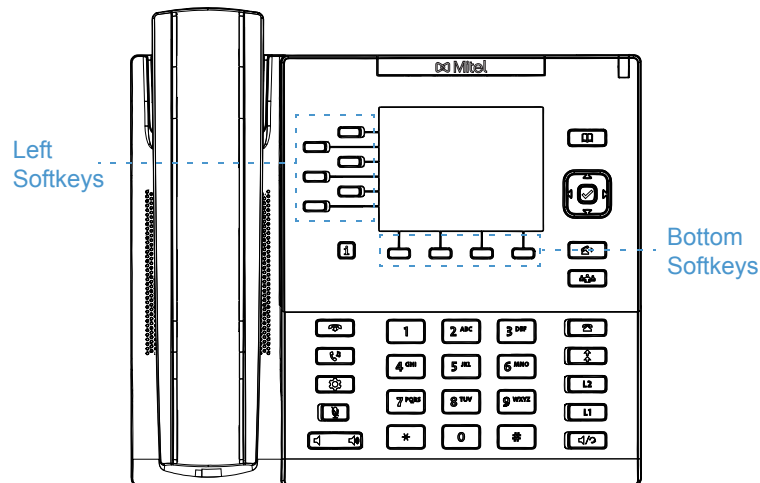

Notes:

1. If M680i Expansion Modules are attached to the phone, you can configure up to an additional 16 softkeys on each M680i Expansion Module.
2. If M685i Expansion Modules are attached to the phone, you can configure up to an additional 84 softkeys on each M685i Expansion Module.
3. The 6867i IP phone allows up to 3 expansion modules on each phone. For more information about expansion modules, see [“Model M680i and M685i Expansion Modules”](#) on page ccxxix.

You can use the Mitel Web UI to configure key functions.

The following table lists the functions you can set on the softkeys and provides a description for each function.

KEY FUNCTION	DESCRIPTION
None	Indicates the key has no function assigned.
Line	Indicates the key is configured for line use (programmable on the left softkeys only).
Speed Dial	Indicates the key is configured for speed dial use.
Do Not Disturb	Indicates the key is configured for Do Not Disturb (DND) functionality.
BLF	Indicates the key is configured for Busy Lamp Field (BLF) functionality (programmable on the left softkeys only).
BLF/List	Indicates the key is configured for BLF/List functionality (programmable on the left softkeys only).

KEY FUNCTION	DESCRIPTION
Auto Call Distribution (ACD)	(For Sylanro Call Managers) Indicates the key is configured to allow the Sylanro call managers to distribute calls from a queue to registered IP phone users (agents) (programmable on the left softkeys only).
XML	Indicates the key is configured to accept an XML application for accessing customized XML services.
Flash	Indicates the key is set to generate a flash event when it is pressed. The IP phone generates flash events only when a call is connected and there is an active RTP stream (for example, when the call is not on hold).
Sprecode	Indicates the key is configured to automatically activate specific services offered by the server. For example, if the sprecode value of *82 is configured, then by pressing the Sprecode key, *82 automatically activates a service provided by the call manager.
Park	Indicates the key is configured to park incoming calls when pressed.
Pickup	Indicates the key is configured to pick up parked calls when pressed.
Last Call Return	Indicates the key is configured for Last Call Return functionality when pressed.
Call Fwd	Indicates the key is configured as a Call Forward key. When pressed, the IP phone UI displays the Call Forward menus.
BLF/Xfer	Indicates the key is configured as a simplified BLF key and a Transfer key. You can use this key to perform the BLF function as well as use it as a transfer key to transfer calls (programmable on the left softkeys only).
Speed Dial/Xfer	Indicates the key is configured as a simplified speed dial key and a transfer key. You can use this key to perform speed dial functions as well as use it as a transfer key to transfer calls.
Speed Dial/Conf	Indicates the key is configured as a speed dial key and a conference key. You can use this key to speed dial from within a conference call and add the new call directly to the conference.
Speed Dial/MWI	Indicates the key is configured as a speed dial key for a voicemail account. You can use this key to monitor and call a voicemail account. Configuring multiple Speedial/MWI keys allows you to monitor and call multiple voicemail accounts.
Directory	Indicates the key is configured to access the Directory.
Filter	Indicates the key is configured for activating/deactivating Executive Call Filtering. For more information about the Executive and Assistant Services feature, see BroadSoft BroadWorks Executive and Assistant Services on page ccxv.
Received Callers List	Indicates the key is configured to access the Received Callers List.
Outgoing Redial	Indicates the key is configured to access the Outgoing Redial List.
Conference	Indicates the key is configured to initiate a conference call.
Transfer	Indicates the key is configured to initiate a call transfer.
Icom	Indicates the key is configured to be used for intercom calls.
Phone Lock	Indicates the key is configured as a phone lock key, allowing you to press this key to lock/unlock the phone.

KEY FUNCTION	DESCRIPTION
Paging	Indicates the key is configured as a Paging key. When pressed, the phone can send Real Time Transport Protocol (RTP) streams from a pre-configured multicast address without involving SIP signaling.
Login	Indicates the key is configured as a Visitor Desk Phone (VDP) Login key. For VDP feature availability and details, please contact your System Administrator.
Discreet Ringing	Indicates the key is configured as a Discreet Ringing key. When the Discreet Ringing feature is enabled, if a call is incoming, the phone will play the configured ring tone once only. Pressing the Discreet key will allow you to toggle on/off the feature.
Call History	Indicates the key is configured as a Call History key. When pressed, the Call History softkey allows users the ability to directly access the list of all calls in the Call History.
Empty	Indicates the key has no function assigned but should be displayed as any empty softkey on the phone's screen.



Note: Keys can also be set up to quickly to access features such as call return (*69) or voicemail. Quick access features like call return and voicemail must first be configured on your PBX in order to work on your phone. See your System Administrator for more information.

STATE-BASED SOFTKEYS

On the 6867i's bottom softkeys, you can configure a specific state to display when a softkey is being used. The following table describes the states available to configure for the softkeys.

STATE	DESCRIPTION
Idle	The phone is not being used.
Connected	The current line is in an active call (or the call is on hold).
Incoming	The phone is ringing.
Outgoing	The user is dialing a number, or the far-end is ringing.
Busy	The current line is busy because the line is in use or the line is set as DND.

The following table identifies the applicable default states for each softkey type on the IP phone.

SOFTKEY TYPE	DEFAULT STATES
None	All states disabled.
Speed Dial	Idle, Connected, Incoming, Outgoing, Busy
DND	Idle, Connected, Incoming, Outgoing, Busy
XML	Idle, Connected, Incoming, Outgoing, Busy
Flash	All states disabled.
Sprecode	Connected
Park	Connected
Pickup	Idle, Outgoing

SOFTKEY TYPE	DEFAULT STATES
Last Call Return	Idle, Connected, Incoming, Outgoing, Busy
Call Forward	Idle, Connected, Incoming, Outgoing, Busy
Speed Dial/Xfer	Idle, Connected, Incoming, Outgoing, Busy
Speed Dial/Conf	Idle, Connected, Incoming, Outgoing, Busy
Speed Dial/MWI	Idle, Connected, Incoming, Outgoing, Busy
Directory	Idle, Connected, Incoming, Outgoing, Busy
Filter	Idle, Connected, Incoming, Outgoing, Busy
Received Callers List	Idle, Connected, Incoming, Outgoing, Busy
Outgoing Redial	Idle, Connected, Incoming, Outgoing, Busy
Conference	Idle, Connected, Incoming, Outgoing, Busy
Transfer	Idle, Connected, Incoming, Outgoing, Busy
Intercom	Idle, Connected, Incoming, Outgoing, Busy
Phone Lock	All states disabled.
Paging	All states disabled.
Login	Idle, Connected, Incoming, Outgoing, Busy
Discreet Ringing	Idle, Connected, Incoming, Outgoing, Busy
Call History	Idle, Connected, Incoming, Outgoing, Busy
Empty	Idle, Connected, Incoming, Outgoing, Busy

In the Mitel Web UI, the operational states for each softkey display as enabled. To disable a state, simply uncheck the box for the respective state.

SOFTKEY DISPLAY BEHAVIOR

On the 6867i IP phone, you can configure up to 20 (left) and 18 (bottom) functions on the softkeys. If you have no softkeys configured on the IP phone, and you assign softkey functions to higher number keys in the Mitel Web UI, the key functions automatically appear in the first available position on the LCD display.

For example, if left softkeys 1 through 20 are set to **None**, and you set the left softkey 12 as the following:

Type: Speed Dial
 Label: Home
 Value: 3456

after saving the settings, the “Home” label actually appears in position 1 of the LCD.

A softkey function of **None** does not display on the **Home** screen at all.

The following figures illustrate the above scenario (i.e. the configuration of left softkey 12) and how it is displayed on the phone:

Mitel Web UI Configuration

Softkeys Configuration

Bottom Keys		Top Keys		
Key	Type	Label	Value	Line
1	None			1
2	None			1
3	None			1
4	None			1
5	None			1
6	None			1
7	None			1
8	None			1
9	None			1
10	None			1
11	None			1
12	Speeddial	John Doe	3456	1

Corresponding 6867i Display

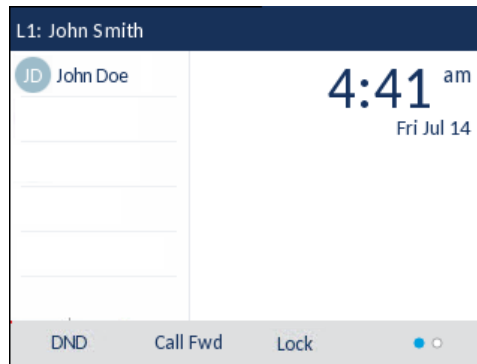

Note: Contact your System Administrator for other softkey display behavior options.

LINE KEY



Note: Line functionality can only be programmed on the left softkeys.

You can set a softkey to act as a line/call appearance key on the 6867i. This key acts as a line that behaves the same as a hard line key (L1 and L2). For more information about the behavior of **Line** keys, see “[Line and Call Appearances](#)” on [page lxxviii](#).

CONFIGURING A LINE KEY USING THE MITEL WEB UI

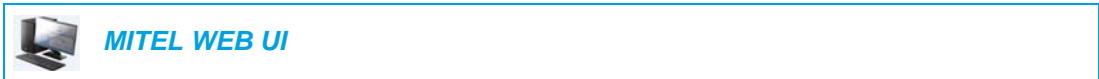

1. Click on **Operation > Softkeys and XML**.
or
Click on **Operation > Expansion Module <N>**.

Softkeys Configuration

Bottom Keys | Top Keys

Key	Type	Label	Value	Line
1	Line	Line 3		3
2	None			1
3	None			1
4	None			1
5	None			1

Softkeys

2. Select from **Key 1** through **Key 20** on the top keys.
3. In the **Type** field, select **Line** to apply to the key.
4. In the **Label** field, enter a label to apply to this key.
5. In the **Line** field, select a line to apply to this key.
Valid values are **3** through **24**.

Expansion Module Keys

6. Select from **Key 1** through **Key 16** (M680i) or **Key 84** (M685i).
7. In the **Line** field, select a line to apply to this key.
Valid values are **3** through **24**.
8. Click **Save Settings**.

SPEED DIAL KEY

The normal function of the speed dial option allows you to dial a number quickly by pressing a key configured for speed dialing. You can program the keys on the 6867i to speed dial outside numbers, dial directly to another person's line or extension, or quickly access features such as Caller ID (*69) and voicemail.



Note: You can use a **Speed Dial** key while on an active call by placing the active call on hold first, and then pressing the speed dial key.

You can create **Speed Dial** keys using any of the following methods:

- Using the Mitel Web UI at the paths:
 - Operation > Softkeys and XML
 - Operation > Expansion Module Keys
- Using the IP phone UI at the path *Options > Dialing > Speed Dial Edit*
- By pressing and holding a softkey, dialpad key, or expansion module key.

SPEED DIAL PREFIX

The speed dial feature also allows you to specify a preset string of numbers followed by a + that the phone dials automatically after pressing the speed dial key. You can use this feature for numbers that contain long prefixes.

For example, if you had the following speed dial configuration in the Mitel Web UI:

Key 1
Type: Speed Dial
Label: Europe Office
Value: 1234567+
Line: 2

Then, after you press key 1 on the phone, the prefix number displays on the phone screen. The phone proceeds to dial the prefix number automatically and pauses for you to enter the remaining phone number using the dialpad on the phone.

Use the following procedures to set speed dial on the 6867i IP phone.

PRESS-AND-HOLD TO CREATE A SPEED DIAL (APPLICABLE TO SOFTKEYS, DIALPAD KEYS, EXPANSION MODULE KEYS)

Pressing and holding down a softkey, dialpad key, or expansion module key on the phone initiates a speed dial feature.



Notes:

1. When creating a **Speed Dial** key from the IP phone UI, you must select a softkey, dialpad key, or expansion module key that has no preassigned function (key must be set to **None** or **Empty**).
2. If there are no empty softkeys on the home screen, you can press and hold the **More** softkey to configure the next available softkey with speeddial functionality. If a More softkey is not available, use the **Dialing > Speed Dial Edit** option in the Options List to configure a new speeddial key.

 **IP PHONE UI**

1. Press and hold an non-configured softkey, dialpad key, or expansion module key for three seconds.

Softkey/Expansion Module Key Press-and-Hold Speed Dial Edit Menu



Dialpad Key Press-and-Hold Speed Dial Edit Menu

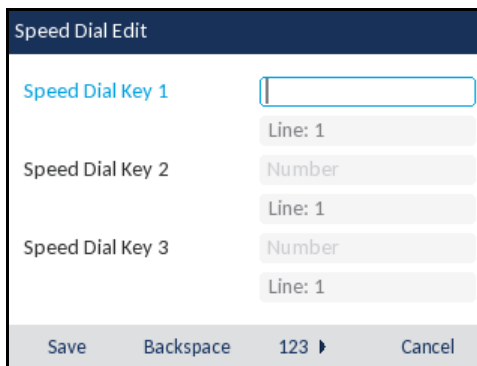

Note: You can press the **Cancel** softkey at any time during the speed dial programming to cancel and not save the speed dial information.

2. In the **Label** field (if applicable), enter a label to apply to the key.



Note: If necessary, use the **ABC** 4 softkey to specify uppercase letters or lowercase letters when entering the label

3. Press the **▲** key to move to the **Number** field (if applicable) and enter a number for the speed dial key using the dialpad keys.
4. Press the **▲** key to move to the **Line** field and select a line to apply to the key. This is the line that the phone opens to dial the number after you press the respective **Speed Dial** key. By default, the phone uses Line 1 for the **Speed Dial** key. If you want to use a different line, press the **◀** and **▶** keys to select another line.
5. Press the **Save** softkey to save the speed dial information to the key you selected.

CREATING A SPEED DIAL KEY USING THE SPEED DIAL EDIT OPTION
(APPLICABLE TO SOFTKEYS, DIALPAD KEYS, EXPANSION MODULE KEYS)

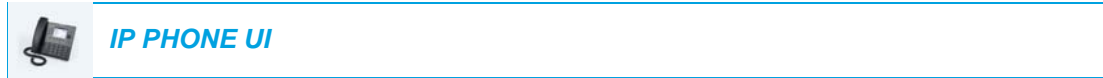

1. Press on the phone to enter the Options List.
2. Navigate to the **Dialing > Speed Dial Edit** option and press the button or **Select** softkey.

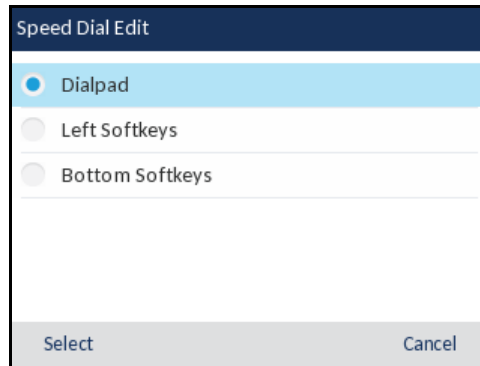

Note: You can press the **Cancel** softkey at anytime during the speed dial programming to cancel and not save the speed dial information.

3. Navigate to the desired type of keys you want to edit (e.g. Left Softkeys) and press the button or **Select** softkey.

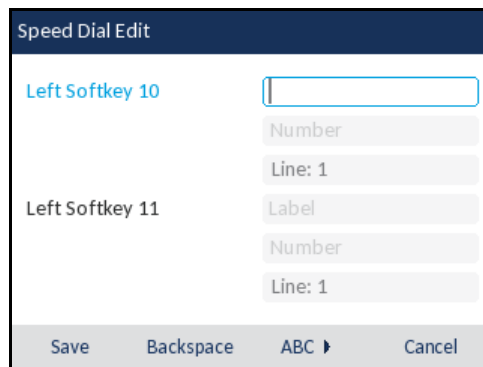

4. Navigate to the desired key (by pressing the key) and in the **Label** field (if applicable), enter a label to apply to the key.

Note: If necessary, use the **ABC 4** softkey to specify uppercase letters or lowercase letters when entering the label.

5. Press the key to move to the **Number** field (if applicable) and enter a number for the key using the dialpad keys.
6. Press the key to move to the **Line** field and select a line to apply to the key. This is the line that the phone opens to dial the number after you press the respective **Speed Dial** key. By default, the phone uses Line 1 for the **Speed Dial** key. If you want to use a different line, press the and keys to select another line.

- Press the **Save** softkey to save the speed dial information to the key you selected.

CREATING A SPEED DIAL SOFTKEY USING THE MITEL WEB UI



- Click on **Operation > Softkeys and XML**.
or
Click on **Operation > Expansion Module <N>**.

Softkeys Configuration

Bottom Keys		Top Keys		
Key	Type	Label	Value	Line
1	Speeddial	Home	8051234567	1
2	None			1
3	None			1
4	None			1
5	None			1

Softkeys

- Select from **Key 1** through **Key 20** on the Top keys.
or
Select from **Key 1** through **Key 18** on the Bottom keys.
- In the **Type** field, select **Speed Dial** to apply to the key.
- In the **Label** field, enter a label to apply to this key.
- In the **Value** field, enter the phone number, extension, or speed dial prefix to apply to this key. If you enter a speed dial prefix, you must enter the + character at the end of the prefix number (for example, 123456+).
- In the **Line** field, select a line to apply to this key. Valid values are **1** through **24**.
- In the state fields, check (enable) or uncheck (disable) the states you want to apply to this softkey.

Expansion Module Keys

- Select from **Key 1** through **Key 16** (M680i) or **Key 84** (M685i).
- In the **Type** field, select **Speed Dial** to apply to the key.
- In the **Value** field, enter the phone number, extension, or speed dial prefix to apply to this key. If you enter a speed dial prefix, you must enter the + character at the end of the prefix number (for example, 123456+).
- In the **Line** field, select a line to apply to this key. Valid values are **1** through **24**.
- Click **Save Settings**.

CREATING DIALPAD SPEED DIAL KEYS USING THE MITEL WEB UI



MITEL WEB UI

1. Click on **Operation > Keypad Speed Dial**.

Keypad Speed Dial

Key	Value	Line
1	<input type="text" value="9051234567"/>	<input type="text" value="1"/>
2	<input type="text"/>	<input type="text" value="1"/>
3	<input type="text"/>	<input type="text" value="1"/>
4	<input type="text"/>	<input type="text" value="1"/>
5	<input type="text"/>	<input type="text" value="1"/>
6	<input type="text"/>	<input type="text" value="1"/>
7	<input type="text"/>	<input type="text" value="1"/>
8	<input type="text"/>	<input type="text" value="1"/>
9	<input type="text"/>	<input type="text" value="1"/>

2. Select a key from **1** through **9**.
3. In the input box, enter the phone number, extension, or speed dial prefix to apply to this digit key. If you enter a speed dial prefix, you must enter the + character at the end of the prefix number (for example, 123456+).
4. In the **Line** field, select a line for which to apply the speed dial to. Valid values are **1** through **24**.
5. Click **Save Settings**.

DO NOT DISTURB (DND) KEY

The IP phones have a feature you can enable called Do Not Disturb (DND). Configuring a DND softkey allows you to quickly turn the DND feature on or off.

If DND is enabled, callers calling into the phone hear a busy signal or a message, depending on how your System Administrator set up the configuration server. When DND is enabled, the  icon is displayed on screen in both the status bar and beside the corresponding softkey.

If the phone shares a line with other phones, only the phone that has DND configured is affected.

For more information about DND and DND modes, see “DND Configuration” on page clxxxiii.

CONFIGURING A DND KEY USING THE MITEL WEB UI



1. Click on **Operation > Softkeys and XML**.
or
Click on **Operation > Expansion Module <N>**.

Softkeys Configuration

Key	Type	Label	Value	Line
1	Do Not Disturb			1
2	None			1
3	None			1
4	None			1
5	None			1

Softkeys

2. Select from **Key 1** through **Key 20** on the Top keys.
or
Select from **Key 1** through **Key 18** on the Bottom keys.
3. In the **Type** field, select **Do Not Disturb** to apply to the key.
4. In the state fields, check (enable) or uncheck (disable) the states you want to apply to this softkey.

Expansion Module Keys

5. Select from **Key 1** through **Key 16** (M680i) or **Key 84** (M685i).
6. In the **Type** field, select **Do Not Disturb** to apply to the key.
7. Click **Save Settings**.

BUSY LAMP FIELD (BLF) KEY



Notes:

1. BLF functionality can only be programmed on the left softkeys but BLF indicators can be viewed through the Directory, Received Callers, and Outgoing Redial Lists.
2. BLF feature availability is dependent on your call manager. Contact your System Administrator for more information.

The BLF feature on the IP phones allows a specific extension to be monitored for state changes. BLF monitors the status (busy or idle) of extensions on the IP phone.

For example, a Supervisor configures BLFs on his phone for monitoring the status of a co-worker’s phone use (busy or idle). If the co-worker’s phone is in an idle state, the **BLF** softkey on the Supervisor’s phone is green. If the co-worker’s phone is ringing, the **BLF** softkey on the Supervisor’s phone is yellow. If the co-worker is on a call or when the co-worker picks up his phone to make a call, the **BLF** softkey on the Supervisor’s phone turns red, indicating that the worker’s phone is in use and busy. Lastly, if the co-worker’s call is on hold, the **BLF** softkey on the Supervisor’s phone displays the BLF hold icon. Additionally, the corresponding softkey LED illuminates to match the monitored user’s state, either off (idle), solid (busy), or fast flashing/slow flashing (ringing/on hold).



Note: You can also use a BLF-configured key to automatically dial the BLF-monitored extension. Contact your System Administrator for more information.

The following table provides the BLF states on the phone and the corresponding LED and icon behavior:

BLF State	LED Behavior	Softkey Icon
Idle	Off	
Ringing	Fast Flashing Red	
Connected	Solid Red	
On Hold	Slow Flashing Red	
Unknown	Off	

BLF State

LED Behavior

Softkey Icon

Not monitored

Off



CONFIGURING A BLF KEY USING THE MITEL WEB UI

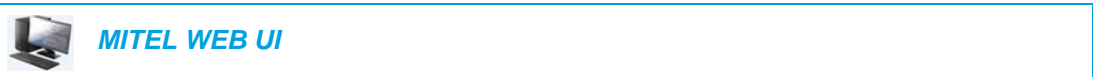

1. Click on **Operation > Softkeys and XML.**
or
Click on **Operation > Expansion Module <N>.**

Softkeys Configuration

Bottom Keys | Top Keys

Key	Type	Label	Value	Line
1	BLF	Martha	4000	1
2	None			1
3	None			1
4	None			1
5	None			1

Softkeys

2. Select from **Key 1** through **Key 20** on the Top keys.
3. In the **Type** field, select **BLF** to apply to the key.
4. In the **Label** field, enter a label to apply to this key.
5. In the **Value** field, enter the phone number or extension you want to monitor.
6. In the **Line** field, select a line for which to apply this key. Valid values are:
 - global
 - 1 through 24

Expansion Module Keys

7. Select from **Key 1** through **Key 16** (M680i) or **Key 84** (M685i).
8. In the **Value** field, enter the phone number or extension you want to monitor.
9. In the **Line** field, select a line for which to apply this key. Valid values are:
 - global
 - 1 through 24
10. Click **Save Settings.**

BLF/LIST KEY



Notes:

1. BLF/List functionality can only be programmed on the left softkeys but BLF/List indicators can be viewed through the Directory, Received Callers, and Outgoing Redial Lists.
2. For use with the BroadSoft BroadWorks Release 13 or higher platform only. Your System Administrator must have BLF/List enabled on the BroadWorks call manager. Contact your System Administrator for more information.

The BLF/List feature on the IP phones is specifically designed to support the BroadSoft BroadWorks Release 13 Busy Lamp Field feature.

This feature allows the IP phone to subscribe to a list of monitored users defined through the BroadWorks web portal.

In addition to monitoring the idle and busy state, the BLF/List feature also supports the ringing and held state. When the monitored user is idle, the corresponding softkey is green. When the monitored user's phone is ringing, the corresponding softkey turns yellow. When the monitored user on an active call or is attempting to make a call, the corresponding softkey turns red. Finally, when the monitored user's call is on hold, the corresponding softkey displays the BLF/List hold icon. Additionally, the corresponding softkey LED illuminates to match the monitored user's state, either off (idle), solid (busy), or fast flashing/slow flashing (ringing/on hold).





Notes:

1. You can use a BLF/List-configured key to automatically dial out to the configured extension.
2. The BroadWorks BLF feature is not the same as the BroadWorks Shared Call Appearance (SCA) feature and does not permit call control over the monitored extension.

The following table provides the BLF/List states on the phone and the corresponding LED and icon behavior:

BLF/List State	LED Behavior	Softkey Icon
Idle	Off	
Ringing	Fast Flashing Red	
Connected	Solid Red	

BLF/List State	LED Behavior	Softkey Icon
Unknown	Off	
Not Monitored	Off	

For both BLF and BLF/List, the parameter "XXXkeyN ring splash" is applicable when the "...keyN ring splash" value is set to control the ring splash alert pattern.

CONFIGURING A BLF/LIST KEY USING THE MITEL WEB UI

If you set a key to use BLF/List, you must also enter a **BLF List URI** at *Operation > Softkeys and XML > Services*. The **BLF List URI** is the name of the BLF list defined on the BroadSoft BroadWorks Busy Lamp field page for your particular user. For example, sip:9@192.168.104.13. The value of the **BLF List URI** parameter must match the list name configured. Otherwise, no values display on the 6867i screen and the feature is disabled.

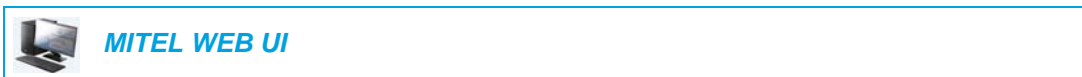

1. Click on **Operation > Softkeys and XML**.
or
Click on **Operation > Expansion Module <N>**.

Softkeys Configuration

Bottom Keys | **Top Keys**

Key	Type	Label	Value	Line
1	BLF/List			1
2	None			1
3	None			1
4	None			1
5	None			1

Services

XML Application URI:

XML Application Title:

BLF List URI:

Softkeys

2. Select from **Key 1** through **Key 20** on the Top keys.
3. In the **Type** field, select **BLF/List** (BroadSoft BroadWorks).
4. In the **Line** field, select a line number that is actively registered to the appropriate SIP proxy you are using. Valid values are:
 - global

- 1 through 24



Note: The **Label** and **Value** field are not required. The BroadWorks BLF/List name is configured in the **BLF List URI** field instead.

5. In the state fields, check (enable) or uncheck (disable) the states you want to apply to this softkey.
6. In the **BLF List URI** field, enter the name of the BLF list defined on the BroadSoft BroadWorks Busy Lamp field page for your particular user. For example, sip:9@192.168.104.13.



Note: Contact your System Administrator for the **BLF List URI**.

Expansion Module Keys

7. Select from **Key 1** through **Key 16** (M680i) or **Key 84** (M685i).
8. In the **Line** field, select a line for which to apply this key. Valid values are:
 - global
 - 1 through 24



Note: The **Value** field is not required. The BroadWorks BLF/List name is configured in the **BLF List URI** field instead.

9. In the **BLF List URI** field, enter the name of the BLF list defined on the BroadSoft BroadWorks Busy Lamp field page for your particular user. For example, sip:9@192.168.104.13.



Note: Contact your System Administrator for the **BLF List URI**.

10. Click **Save Settings**.

CONFIGURING XMPP AVATAR

When the XMPP Avatar for picture ID is configured on the phone, the available image is displayed on the phone (it can be XMPP Avatar image as well).

And if the image is not available, the phone downloads it from the image server and displays the image of a blue man.

XMPP can be configured in these two scenarios:

If XMPP enabled

The phone checks for XMPP avatar and the image in the image database.

If XMPP not enabled

The phone only checks the availability of the image in the image database. (XMPP avatar is not checked as it is not enabled.)

AUTOMATIC CALL DISTRIBUTION (ACD) KEY (FOR SYLANTRO CALL MANAGERS)



Note: ACD functionality can only be programmed on the left softkeys.

The 6867i and any attached expansion modules support Automatic Call Distribution (ACD) for Sylanthro call managers. The ACD feature allows the Sylanthro call manager to distribute calls from a queue to registered IP phone users (agents).

To use the ACD feature on an IP phone, you must first configure an **ACD** softkey or expansion module key. When you want to subscribe to a queue (in order to receive incoming calls), you press the **ACD** softkey and the IP phone UI prompts you to log in.

Available/Unavailable is displayed indicating the current status of the IP phone (specifies if the IP phone user is available/unavailable to receive a call from the queue).

Additionally, the **ACD** softkey indicates your current ACD status turning from red (logged out) to yellow (logged in but unavailable) to green (logged in and available), and the corresponding LED also changes as per the table below:

STATUS: LOGGED IN AND AVAILABLE

STATUS: LOGGED IN AND UNAVAILABLE

LOGGED OUT

Solid Red LED

Blinking Red LED

No LED

When you are on an active call, or you miss a call, the server automatically changes the phone's status to unavailable. The server updates its database with this new information and no longer distributes calls to the phone. The phone remains in this unavailable state until:

- You make yourself available again by pressing the **Avail** softkey
- An ACD timer expires (set by your System Administrator)

You can also choose to manually change the phone status to unavailable by pressing the **Unavail** softkey on the phone.



Note: It is recommended you configure no more than a single **ACD** softkey or expansion module key per IP phone.

CONFIGURING AN AUTOMATIC CALL DISTRIBUTION (ACD) KEY USING THE MITEL WEB UI



1. Click on **Operation > Softkeys and XML.**
or
Click on **Operation > Expansion Module <N>.**

Softkeys Configuration

Bottom Keys | **Top Keys**

Key	Type	Label	Value	Line
1	Auto call distribution	Sales-Queue		1
2	None			1
3	None			1
4	None			1
5	None			1

Softkeys

2. Select from **Key 1** through **Key 20** on the Top keys.
3. In the **Type** field, select **Auto call distribution**.
4. In the **Label** field, enter a label to apply to this ACD key.
5. In the **Line** field, select a line to apply Automatic call distribution. Valid values are **1** through **24**.

Expansion Module Keys

6. Select from **Key 1** through **Key 16** (M680i) or **Key 84** (M685i).
7. In the **Line** field, select a line to apply Automatic call distribution. Valid values are **1** through **24**.
8. Click **Save Settings**.

UTILIZING THE ACD FEATURE USING THE IP PHONE UI



1. Check with your Administrator to verify the queue linked to your ACD softkey.
2. Press the **ACD** softkey on your IP phone.

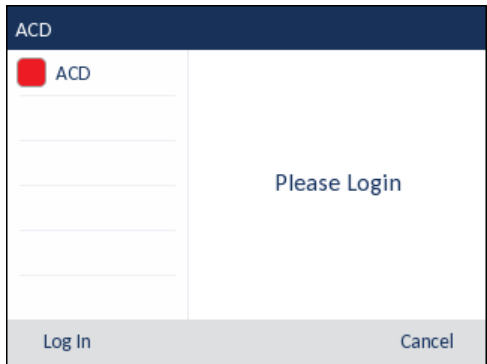

3. Press the **Login** softkey.
Your phone logs into the queue on the server.

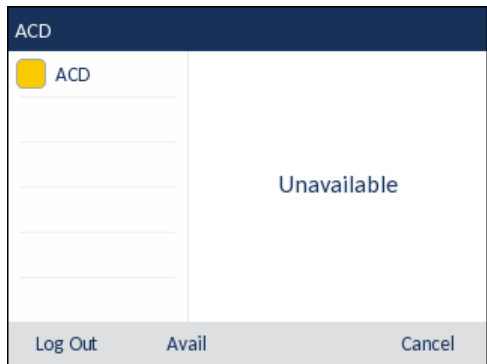

4. To allow your phone to be available in the queue, press the **Avail** softkey.
The following screen displays.

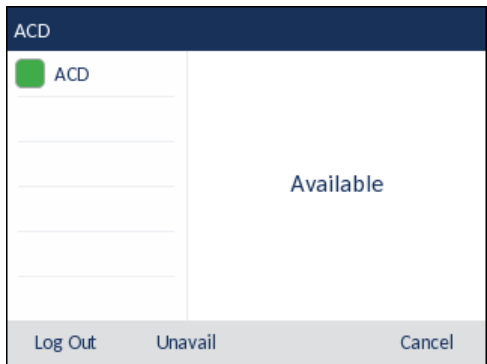

If your IP phone status is set to **Available** then the server begins to distribute phone calls from this queue to your IP phone. You must manually change the state to **Available** in order to start receiving calls.

5. To temporarily stop receiving calls, press the **Unavail** softkey.

If you are on a call (or miss a call that has been distributed to your phone), your phone status automatically changes to **Unavailable**. Your phone remains in the **Unavailable** state until one of the following occurs:

- You use the IP phone UI to manually switch the IP phone state back to **Available** or
 - The availability timer for your IP phone expires. This only occurs if your Administrator has configured an auto-availability timer on your IP phone. Contact your System Administrator for more information.
6. To logout of the queue, press the **Log Out** softkey. The server no longer distributes phone calls to your IP phone.

XML KEY

The 6867i IP phone has a feature you can enable called XML (Extensible Markup Language). XML is a markup language much like HTML. Your System Administrator can create customized XML menu services and load them to your IP phone. These services include things like weather and traffic reports, contact information, company info, stock quotes, or custom call scripts.



Note: The XML services must be set up by your System Administrator before you can use the key.

On the 6867i IP phone, you can access the XML applications from the IP phone UI via an **XML** softkey.

Using the Mitel Web UI, you can configure a key to access XML applications. Under *Operations > Softkeys and XML*, or *Operations > Expansion Module*, you can assign a key the type **XML**.

CONFIGURING AN XML KEY USING THE MITEL WEB UI



MITEL WEB UI

1. Click on **Operation > Softkeys and XML**.
or
Click on **Operation > Expansion Module <N>**.

Softkeys Configuration

Bottom Keys | **Top Keys**

Key	Type	Label	Value	Line
1	XML	XML		1
2	None			1
3	None			1
4	None			1
5	None			1

Services

XML Application URI:

XML Application Title:

BLF List URI:

Softkeys

2. Select from **Key 1** through **Key 20** on the Top keys.
or
Select from **Key 1** through **Key 18** on the Bottom keys.
3. In the **Type** field, select **XML**.
4. In the **Label** field, enter a label to apply to this key.

5. In the **Value** field, enter a URI(s) to apply to this key.



Note: Contact your System Administrator for the appropriate value(s) to enter in the **Value** field.

6. In the state fields, check (enable) or uncheck (disable) the states you want to apply to this softkey.

Expansion Module Keys

7. Select from **Key 1** through **Key 16** (M680i) or **Key 84** (M685i).

8. In the **Type** field, select **XML**.

9. In the **Value** field, enter a URI(s) to apply to this key.



Note: Contact your System Administrator for the appropriate value(s) to enter in the **Value** field.

10. Click **Save Settings**.

ACCESSING THE XML SERVICE USING THE IP PHONE UI

After an XML application(s) has been saved to your IP phone and a key has been configured to access the XML applications, the customized service is ready for you to use.



IP PHONE UI

1. Press the **XML** softkey on the 6867i phone. An XML screen displays.
2. Use the **▲** and **▼** keys to scroll through the customized features.
3. For menu and directory services, select a service to display the information for that customized service. Message services display to the screen after pressing the respective key. For user input services, follow the on-screen prompts.
4. To exit from the XML screen, press the **XML** softkey again or press the  button.

FLASH KEY

You can set a key to generate a flash event when it is pressed on the 6867i. You do this by setting the key to **Flash**. The IP phone generates flash events only when a call is connected and there is an active RTP stream (for example, when the call is not on hold).

CONFIGURING A FLASH KEY USING THE MITEL WEB UI

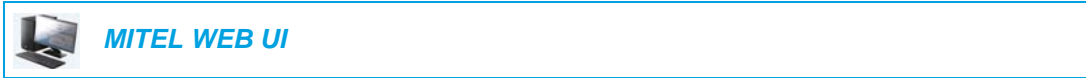

1. Click on **Operation > Softkeys and XML**.
or
Click on **Operation > Expansion Module <N>**.

Softkeys Configuration

Bottom Keys		Top Keys		
Key	Type	Label	Value	Line
1	Flash	Flash		1
2	None			1
3	None			1
4	None			1
5	None			1

Softkeys

2. Select from **Key 1** through **Key 20** on the Top keys.
or
Select from **Key 1** through **Key 18** on the Bottom keys.
3. In the **Type** field, select **Flash**.
4. In the **Label** field, enter a label to display on the phone for the key.

Expansion Module Keys

5. Select from **Key 1** through **Key 16** (M680i) or **Key 84** (M685i).
6. In the **Type** field, select **Flash**.
7. Click **Save Settings**.

SPRECODE KEY

You can set a key to automatically activate specific services offered by the server by setting a key to **Sprecode**. For example, if the sprecode value of *82 is configured, then by pressing the key, *82 automatically activates a service provided by the server. The value you enter for this field is dependent on the services provided by the server. Contact your System Administrator for information about available services.

CONFIGURING A SPRECODE KEY USING THE MITEL WEB UI



MITEL WEB UI

1. Click on **Operation > Softkeys and XML**.
or
Click on **Operation > Expansion Module <N>**.

Softkeys Configuration

Bottom Keys		Top Keys		
Key	Type	Label	Value	Line
1	Sprecode	Sprecode	*82	1
2	None			1
3	None			1
4	None			1
5	None			1

Softkeys

2. Select from **Key 1** through **Key 20** on the Top keys.
or
Select from **Key 1** through **Key 18** on the Bottom keys.
3. In the **Type** field, select **Sprecode**.
4. In the **Label** field, enter a label to display on the IP phone for this key.
5. In the **Value** field, enter the appropriate value for accessing specific services from the server.



Note: For values to enter in this field, contact your System Administrator.

6. In the state fields, check (enable) or uncheck (disable) the **Connected** state for this softkey.

Expansion Module Keys

7. Select from **Key 1** through **Key 16** (M680i) or **Key 84** (M685i).
8. In the **Type** field, select **Sprecode**.

- In the **Value** field, enter the appropriate value for accessing specific services from the server.



Note: For values to enter in this field, contact your System Administrator.

- Click **Save Settings**.

PARK/PICKUP KEYS

The 6867i phone has a park and pickup call feature that allows you to park a call and pickup a call when required. The IP phones support the Park/Pickup feature on the Asterisk, BroadWorks, Sylanro, and ININ call managers.

The park/pickup feature performs as follows:

- When a call comes in and you pickup the handset, you can press the applicable **Park** key to park the call
- After the call is parked, you can press the **Pickup** key, followed by the applicable value to pickup the call

Administrators can configure the **Park** and **Pickup** keys for any line using the configuration files or the Mitel Web UI.

Users can make changes to customize the label of the **Park** and **Pickup** keys using the Web UI.

CONFIGURING PARK/PICKUP KEYS USING THE MITEL WEB UI



MITEL WEB UI

- Click on **Operation > Softkeys and XML**.
or
Click on **Operation > Expansion Module <N>**.

Softkeys Configuration

Bottom Keys | Top Keys

Key	Type	Label	Value	Line
1	Park	Park	*88	1
2	Pickup	Pickup	*88	1
3	None			1
4	None			1
5	None			1

Softkeys

- Select from **Key 1** through **Key 20** on the Top keys.
or
Select from **Key 1** through **Key 18** on the Bottom keys.

3. In the **Type** field, select **Park**.
4. In the **Label** field, enter a label for the **Park** softkey.



Note: The **Value** and **Line** fields are configured by the Administrator.

5. In the state fields, check (enable) or uncheck (disable) the **Connected** state for this softkey.
6. Select from **Key 1** through **Key 20**.
7. In the **Type** field, select **Pickup**
8. In the **Label** field, enter a label for the **Pickup** softkey.



Note: The **Value** and **Line** fields are configured by the Administrator.

9. In the state fields, check (enable) or uncheck (disable) the states you want to apply to this softkey.
10. Click **Save Settings**.
11. Click on **Reset**, then click **Restart** to restart the IP phone and apply the changes.

Expansion Module Keys

12. Select from **Key 1** through **Key 16** (M680i) or **Key 84** (M685i).
13. In the **Type** field, select **Park**.
14. In the **Value** field, enter the appropriate value for accessing specific services from the server.



Note: The **Value** and **Line** fields are configured by the Administrator.

15. Select from **Key 1** through **Key 16** (M680i) or **Key 84** (M685i).
16. In the **Type** field, select **Pickup**.
17. In the **Value** field, enter the appropriate value for accessing specific services from the server.



Note: The **Value** and **Line** fields are configured by the Administrator.

18. Click **Save Settings**.
19. Click on **Reset**, then click **Restart** to restart the IP phone and apply the changes.

UTILIZING THE PARK CALL/PICKUP PARKED CALL FEATURE USING THE IP PHONE UI

Use the following procedure on the IP phone to park a call and pick up a parked call.



Parking a Call

1. While on a live call, press the **Park** key.
2. Perform the following for your specific server:

ASTERISK

Server announces the extension number where the call has been parked. Once the call is parked, press the  key to complete parking.

BROADWORKS

After you hear the greeting from the CallPark server, enter the extension where you want to park the call.

SYLANTRO

Enter the extension number where you want to park the call, followed by # key.

ININ

Enter the extension number where you want to park the call, followed by # key.

If the call is parked successfully, the response is either a greeting voice confirming that the call was parked, or a hang up occurs. The parked call party hears music on hold.

3. If the call fails, you can pick up the call (using the next procedure) and press the **Park** key again to retry Step 2.

Picking Up a Parked Call

1. Pick up the handset on the phone.
2. Enter the extension number where the call was parked.
3. Press the **Pickup** key.
If the call pick up is successful, you are connected with the parked call.

LAST CALL RETURN KEY

Using the Mitel Web UI, you can configure the Last Call Return function on a key. If you configure Last Call Return on a key, and a call comes into your phone, after you are finished with the call and hang up, you can press the key configured for Last Call Return and the phone dials the last call you received. When you configure an **Last Call Return** key, the label **LCR** displays next to that key on the IP phone. When the Sylanro call manager detects an Last Call Return request, it translates this request and routes the call to the last caller.

CONFIGURING A LAST CALL RETURN KEY USING THE MITEL WEB UI



MITEL WEB UI

1. Click on **Operation > Softkeys and XML**.
or
Click on **Operation > Expansion Module <N>**.

Softkeys Configuration

Bottom Keys		Top Keys		
Key	Type	Label	Value	Line
1	Last Call Return			1
2	None			1
3	None			1
4	None			1
5	None			1

Softkeys

2. Select from **Key 1** through **Key 20** on the Top keys.
or
Select from **Key 1** through **Key 18** on the Bottom keys.
3. In the **Type** field, select **Last Call Return**.
4. In the **Line** field, select the line you want to apply to this key.
Valid values are **1** through **24**.
5. In the state fields, check (enable) or uncheck (disable) the states you want to apply to this softkey.

Expansion Module Keys

6. Select from **Key 1** through **Key 16** (M680i) or **Key 84** (M685i).
7. In the **Type** field, select **Last Call Return**.
8. In the **Line** field, select the line you want to apply to this key.
Valid values are **1** through **24**.
9. Click **Save Settings**.

CALL FORWARD KEY

Using the Mitel Web UI, you can configure the Call Forward function on a softkey or expansion module key. Use call forwarding when you want a specific account on your phone to be forwarded to another number when your phone is in the busy state or the no answer state, or both. Pressing the **Call Fwd** softkey on the phone accesses the Call Forward menus. The menu that displays is dependent on the Call Forward mode (**Account** (default), **Phone**, or **Custom**) configured for the phone.

For more information about call forwarding and call forwarding modes, see “[Call Forward Configuration](#)” on [page clxxxviii](#).

CONFIGURING A CALL FORWARD KEY USING THE MITEL WEB UI

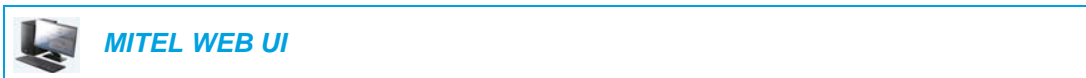

1. Click on **Operation > Softkeys and XML**.
or
Click on **Operation > Expansion Module <N>**.

Softkeys Configuration

Bottom Keys | Top Keys

Key	Type	Label	Value	Line
1	Call Fwd			1
2	None			1
3	None			1
4	None			1
5	None			1

Softkeys

2. Select from **Key 1** through **Key 20** on the Top keys.
or
Select from **Key 1** through **Key 18** on the Bottom keys.
3. In the **Type** field, select **Call Fwd**.
4. In the state fields, check (enable) or uncheck (disable) the states you want to apply to this softkey.

Expansion Module Keys

5. Select from **Key 1** through **Key 16** (M680i) or **Key 84** (M685i).
6. In the **Type** field, select **Call Fwd**.
7. Click **Save Settings**.

BLF/XFER



Note: BLF/Xfer functionality can only be programmed on the left softkeys.

The **BLF** key allows one or more extensions to be monitored, and once there is any state change with those extensions, the key shows the status of the monitored lines. The **Transfer** key allows a call to be transferred to other recipients blindly or consultatively. The **BLF/Xfer** key combines the **BLF** and **Transfer** keys' functionality together allowing the user to transfer calls or use BLF with one key.



Note: It is recommended that you enable the **Switch UI Focus to Ringing Line** parameter when using the BLF/Xfer feature. For more information about this parameter, see [“Switch UI Focus to Ringing Line”](#) on [page cci](#).

BLF/XFER KEY REQUIREMENTS AND FUNCTIONALITY

- BLF/Xfer and BLF: A **BLF/Xfer** key can be configured for subscribing to an extension and monitor the status of the extension, similar to the **BLF** key functionality. Changes of the state of the monitored extension are indicated by the key's graphical button image as well as the key's LED.
- BLF/Xfer and Blind Transfer Calls: When the focused line is in the connected state, pressing the **BLF/Xfer** key transfers the call to the extension unconditionally, disregarding the status of the monitored extension.

If transferring a call to an extension fails, a message **Transfer Failed** displays on the phone, and you can reconnect the call (get the call back) by pressing the line key again.

- BLF/Xfer and Call Forward: When the focused line is in the ringing state, pressing the **BLF/Xfer** key forwards the call to the extension unconditionally, disregarding the status of the monitored extension.
- BLF/Xfer and Speed Dial: When the focused line and the monitored extension are idle, pressing the **BLF/Xfer** key causes the phone to go offhook and dial the number of the extension.

CONFIGURING A BLF/XFER KEY USING THE MITEL WEB UI



1. Click on **Operation > Softkeys and XML.**
or
Click on **Operation > Expansion Module <N>.**

Softkeys Configuration

Bottom Keys | **Top Keys**

Key	Type	Label	Value	Line
1	BLF/Xfer	John	3500	1
2	None			1
3	None			1
4	None			1
5	None			1

Softkeys

2. Select from **Key 1** through **Key 20** on the Top keys.
3. In the **Type** field, select **BLF/Xfer**.
4. In the **Value** field, enter the monitored extension or the extension to transfer calls to (for example, 3500).
5. In the **Line** field, select the line for which you want to use the key functionality.
Valid values are:
 - global
 - 1 through 24

Expansion Module Keys

6. Select from **Key 1** through **Key 16** (M680i) or **Key 84** (M685i).
7. In the **Type** field, select **BLF/Xfer**.
8. In the **Value** field, enter the monitored extension or the extension to transfer calls to (for example, 3500).
9. In the **Line** field, select the line for which you want to use the key functionality.
Valid values are:
 - global
 - 1 through 24
10. Click **Save Settings**.

SPEED DIAL/XFER

The **Speed Dial** key allows a number to be dialed quickly by pressing one key configured for speed dialing. The **Transfer** key allows a call to be transferred to other recipients blindly or consultatively. The **Speed Dial/Xfer** key combines the **Speed Dial** and **Transfer** keys' functionality together allowing the user to transfer calls or speed dial with one key.



Note: It is recommended that you enable the **Switch UI Focus to Ringing Line** parameter when using the Speed Dial/Xfer feature. For more information about this parameter, see “[Switch UI Focus to Ringing Line](#)” on [page cci](#).

SPEED DIAL/XFER KEY REQUIREMENTS AND FUNCTIONALITY

The **Speed Dial/Xfer** key has the following capabilities:

- Speed Dial/Xfer and Speed Dial: When the phone is in the idle state, pressing the **Speed Dial/Xfer** key causes the phone to go offhook and dial the predefined extension.
- Speed Dial/Xfer and Blind Transfer: When the phone is connected to a call, pressing the **Speed Dial/Xfer** key blind transfers the call to the predefined target.

If transferring a call fails, a message **Transfer Failed** displays, and you can reconnect the call (get the call back) by pressing the line key again.

- Speed Dial/Xfer and Call Forward: When the phone is in the ringing state, pressing the **Speed Dial/Xfer** key forwards the call to the predefined extension.

CONFIGURING A SPEED DIAL/XFER KEY USING THE MITEL WEB UI



MITEL WEB UI

1. Click on **Operation > Softkeys and XML**.
or
Click on **Operation > Expansion Module <N>**.

Softkeys Configuration

Bottom Keys | Top Keys

Key	Type	Label	Value	Line
1	Speeddial/Xfer	Jane	3800	1
2	None			1
3	None			1
4	None			1
5	None			1

Softkeys

2. Select from **Key 1** through **Key 20** on the Top keys.
or
Select from **Key 1** through **Key 18** on the Bottom keys.
3. In the **Type** field, select **Speed Dial/Xfer**.

4. In the **Label** field, enter a label for the Speed Dial/Xfer key.
5. In the **Value** field, enter the speed dial extension or the extension to transfer calls to (for example, 3600).
6. In the **Line** field, select the line for which you want to use the key functionality.
Valid values are:
 - global
 - 1 through 24
7. In the state fields, check (enable) or uncheck (disable) the states you want to apply to this softkey.

Expansion Module Keys

8. Select from **Key 1** through **Key 16** (M680i) or **Key 84** (M685i).
9. In the **Type** field, select **Speed Dial/Xfer**.
10. In the **Value** field, enter the speed dial extension or the extension to transfer calls to (for example, 3600).
11. In the **Line** field, select the line for which you want to use the key functionality.
Valid values are:
 - global
 - 1 through 24
12. Click **Save Settings**.

SPEED DIAL/CONF

The 6867i allows you to configure a softkey or expansion module key to be used as a speed dial conference key (**Speed Dial/Conf** key) while remaining in the current call. This key allows a user on a call to conference another party at a pre-defined number while remaining in the call.

For example, while on an active call, a user can use the **Speed Dial/Conf** key to dial a recording service and have the resulting conference recorded.



Note: If currently in a conference, the **Speed Dial/Conf** key is disabled on the active call.

If you configure a softkey or expansion module key as a **Speed Dial/Conf** key and you press this key while on an active call, the focused line changes to the dialing line. A **Cancel** softkey displays on the phone allowing you to abort the conference speed dial if required.



Note: This feature is not compatible with centralized conferencing.

CONFIGURING A SPEED DIAL/CONF KEY USING THE MITEL WEB UI



MITEL WEB UI

1. Click on **Operation > Softkeys and XML**.
or
Click on **Operation > Expansion Module <N>**.

Softkeys Configuration

Bottom Keys		Top Keys		
Key	Type	Label	Value	Line
1	Speeddial/Conf	Jane	3600	1
2	None			1
3	None			1
4	None			1
5	None			1

Softkeys

2. Select from **Key 1** through **Key 20** on the Top keys.
or
Select from **Key 1** through **Key 18** on the Bottom keys.
3. In the **Type** field, select **Speed Dial/Conf**.
4. In the **Label** field, enter a label for the Speed Dial/Conf key.
5. In the **Value** field, enter the speed dial extension or the extension to add to the conference (for example, 3600).

6. In the **Line** field, select the line for which you want to use the key functionality.
Valid values are:
 - global
 - 1 through 24
7. In the state fields, check (enable) or uncheck (disable) the states you want to apply to this softkey.

Expansion Module Keys

8. Select from **Key 1** through **Key 16** (M680i) or **Key 84** (M685i).
9. In the **Type** field, select **Speed Dial/Conf.**
10. In the **Value** field, enter the speed dial extension or the extension to add to the conference (for example, **3600**).
11. In the **Line** field, select the line for which you want to use the key functionality.
Valid values are:
 - global
 - 1 through 24
12. Click **Save Settings**.

SPEED DIAL/MWI



Note: Speed Dial/MWI functionality can only be programmed on the left softkeys.

The 6867i supports multiple voicemail registration by using the Speed Dial/MWI key. This feature can be useful in scenarios where you need to monitor the voicemail accounts of your team members or you need access to your manager’s voicemail messages.

By configuring a programmable key, top softkey, or expansion module softkey as “Speed Dial/MWI” and defining call and voicemail URIs, users can monitor and listen to pending messages on multiple voicemail accounts. When new messages are pending on a monitored voicemail account the corresponding Speed Dial/MWI key’s LED will blink and the UI will display the number of pending messages beside the defined label.

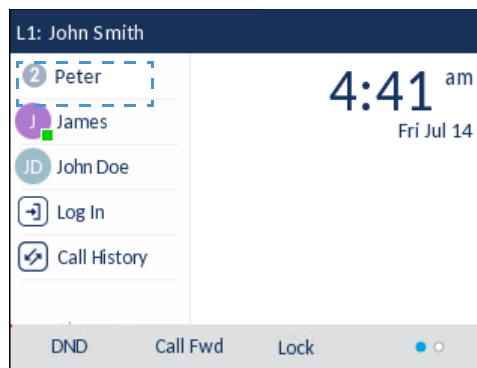

When you press the configured key, the phone will send an INVITE to the configured call URI whereby you will be able to listen to the new messages. The Speed Dial/MWI key can be configured through the Mitel Web UI.

CONFIGURING A SPEED DIAL/MWI KEY USING THE MITEL WEB UI



MITEL WEB UI

1. Click on **Operation > Softkeys and XML**.
or
Click on **Operation > Expansion Module <N>**.

Softkeys Configuration

Bottom Keys		Top Keys		
Key	Type	Label	Value	Line
1	Speeddial/Mwi	Peter	+33123456...3456#00	global
2	None			global
3	None			global
4	None			global
5	None			global

Softkeys

2. Select from **Key 1** through **Key 20** on the Top keys.
3. In the **Type** field, select **Speed Dial/MWI**.
4. In the **Label** field, enter a label to apply to this key. When messages are pending, the phone UI will display the number of pending messages and the defined label.
5. In the **Value** field, enter call URI and voicemail URI separated by a semi-colon, as per the following syntax: [call URI];[voicemail URI]. For example, +33123456,,,3456#0000#@domain;sip:voicemail_peter@domain.



Notes:

1. As the example above illustrates, pauses and DTMF are supported for the call URI.
 2. Ensure that no spaces are added between the call URI and the voicemail URI when defining the key value.
 3. If only one URI is provided, the value will be used for the voicemail URI and the call URI will be left as undefined.
6. In the **Line** field, select the line for which you want to use the key functionality. Valid values are:
 - global
 - 1 through 24
 7. In the state fields, check (enable) or uncheck (disable) the states you want to apply to this softkey.

Expansion Module Keys

8. Select from **Key 1** through **Key 16** (M680i) or **Key 84** (M685i).
9. In the **Type** field, select **Speed Dial/MWI**.
10. In the **Label** field, enter a label to apply to this key. When messages are pending, the phone UI will display the number of pending messages and the defined label.
11. In the **Value** field, enter call URI and voicemail URI separated by a semi-colon, as per the following syntax: [call URI];[voicemail URI]. For example, +33123456,,,3456#0000#@domain;sip:voicemail_peter@domain.



Notes:

1. As the example above illustrates, pauses and DTMF are supported for the call URI.
2. Ensure that no spaces are added between the call URI and the voicemail URI when defining the key value.
3. If only one URI is provided, the value will be used for the voicemail URI and the call URI will be left as undefined.

12. In the **Line** field, select the line for which you want to use the key functionality.

Valid values are:

- global
- 1 through 24

13. Click **Save Settings**.

DIRECTORY KEY

By default, the 6867i has a dedicated **Directory** key. However, using the Mitel Web UI, you can assign the **Directory** key to any key on the left or bottom softkeys on the phone.

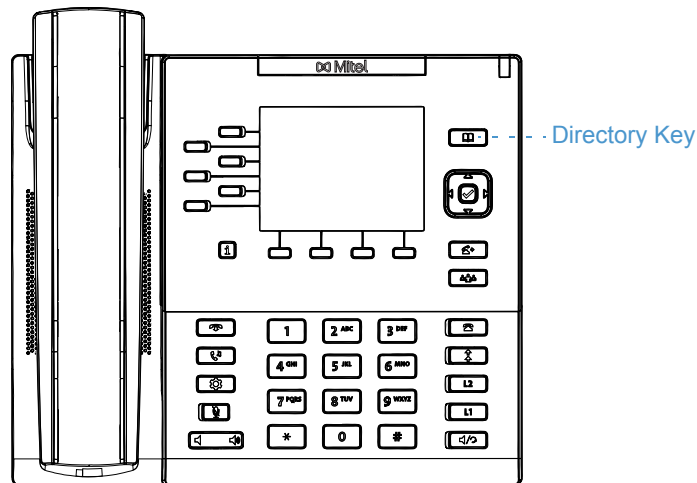

The Directory feature allows you to view Directory entries from multiple sources and store frequently used names and numbers on the phone. You can also dial directly from a Directory entry.

In addition to creating a **Directory** key, you can also download a Directory to your PC, if required, using the Mitel Web UI.



Note: For more information about the Directory, see “[Directory](#)” on [page clxii](#).

CONFIGURING A DIRECTORY KEY USING THE MITEL WEB UI



1. Click on **Operation > Softkeys and XML.**
or
Click on **Operation > Expansion Module <N>.**

Softkeys Configuration

Bottom Keys | Top Keys

Key	Type	Label	Value	Line
1	Directory			1
2	None			1
3	None			1
4	None			1
5	None			1

Softkeys

2. Select from **Key 1** through **Key 20** on the Top keys.
or
Select from **Key 1** through **Key 18** on the Bottom keys.
3. In the **Type** field, select **Directory**.
4. In the **Label** field, enter a label to apply to this key.
5. In the state fields, check (enable) or uncheck (disable) the states you want to apply to this softkey.

Expansion Module Keys

6. Select from **Key 1** through **Key 16** (M680i) or **Key 84** (M685i).
7. In the **Type** field, select **Directory**.
8. Click **Save Settings**.

RECEIVED CALLERS LIST KEY



Note: Received Callers List information in this User Guide describes the phone's native Received Callers List. In some environments, the Received Callers List key may bring up a Received Callers List provided by the call manager; therefore, depending on your call manager, the Received Callers List on your phone may function and behave differently than what is documented in this User Guide. If this is the case, contact your System Administrator for more information regarding your specific Received Callers List.

By default, the 6867i has a dedicated Received Callers List key. However, using the Mitel Web UI, you can assign the **Received Callers List** key to any key on the left or bottom keys on the phone.

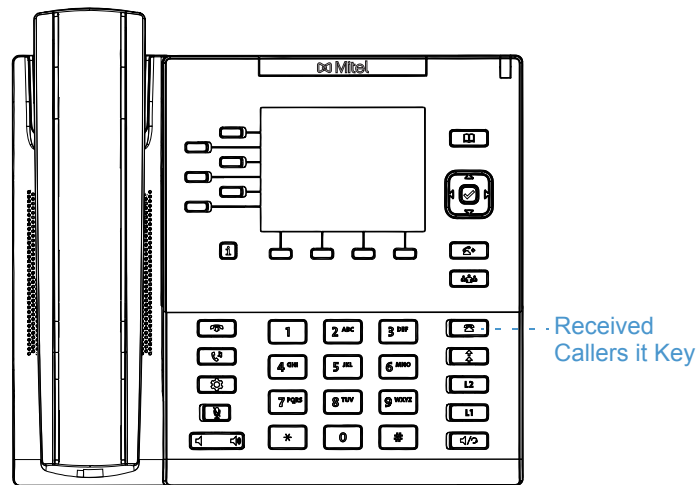

The Received Callers List is a stored log of your incoming calls. You can use the Received Callers List key to access a list of callers that called your phone.



Note: For more information about the Received Callers List, see [“Received Callers List”](#) on [page clxxvi](#).

CONFIGURING A RECEIVED CALLERS LIST KEY USING THE MITEL WEB UI



1. Click on **Operation > Softkeys and XML.**
or
Click on **Operation > Expansion Module <N>.**

Softkeys Configuration

Bottom Keys | Top Keys

Key	Type	Label	Value	Line
1	Callers List	Callers		1
2	None			1
3	None			1
4	None			1
5	None			1

Softkeys

2. Select from **Key 1** through **Key 20** on the Top keys.
or
Select from **Key 1** through **Key 18** on the Bottom keys.
3. In the **Type** field, select **Callers List**.
4. In the **Label** field, enter a label to apply to this key.
5. In the state fields, check (enable) or uncheck (disable) the states you want to apply to this softkey.

Expansion Module Keys

6. Select from **Key 1** through **Key 16** (M680i) or **Key 84** (M685i).
7. In the **Type** field, select **Callers List**.
8. Click **Save Settings**.

OUTGOING REDIAL KEY

By default, the 6867i has a dedicated **Outgoing Redial** key. However, using the Mitel Web UI, you can assign the **Outgoing Redial** key to any key on the left or bottom keys on the phone.

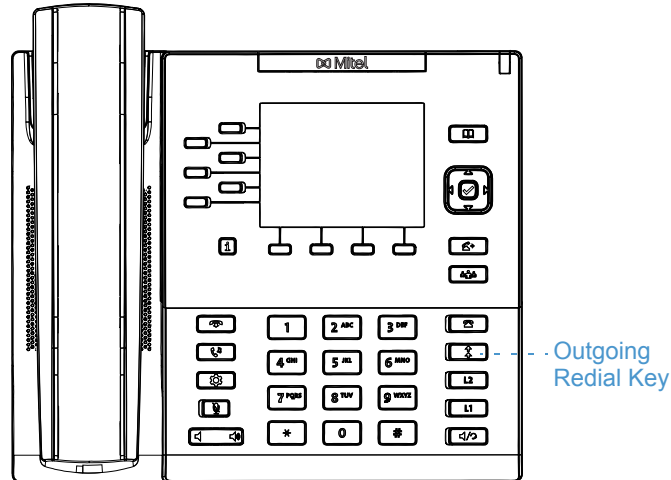

The Outgoing Redial List is a stored log of your outgoing calls. You can use the Outgoing Redial key to access a list of the most recent calls you placed.



Note: For more information about the Outgoing Redial List, see [“Outgoing Redial List”](#) on [page cxli](#).

CONFIGURING A OUTGOING REDIAL KEY USING THE MITEL WEB UI

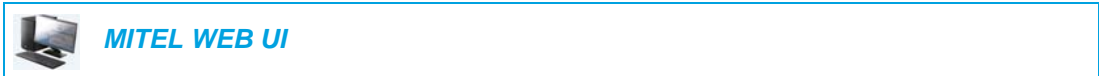

1. Click on **Operation > Softkeys and XML.**
or
Click on **Operation > Expansion Module <N>.**

Softkeys Configuration

Bottom Keys | Top Keys

Key	Type	Label	Value	Line
1	Redial	Redial		1
2	None			1
3	None			1
4	None			1
5	None			1

Softkeys

2. Select from **Key 1** through **Key 20** on the Top keys.
or
Select from **Key 1** through **Key 18** on the Bottom keys.
3. In the **Type** field, select **Redial**.
4. In the **Label** field, enter a label to apply to this key.
5. In the state fields, check (enable) or uncheck (disable) the states you want to apply to this softkey.

Expansion Module Keys

6. Select from **Key 1** through **Key 16** (M680i) or **Key 84** (M685i).
7. In the **Type** field, select **Redial**.
8. Click **Save Settings**.

CONFERENCE KEY

By default, the 6867i has a dedicated **Conference** key. However, using the Mitel Web UI, you can assign the **Conference** key to any key on the left or bottom keys on the phone.

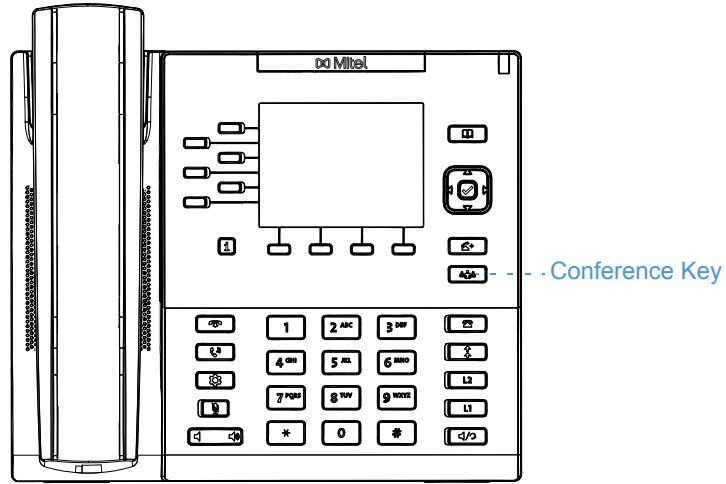

Note: For more information about conferencing, see “[Conferencing Calls](#)” on [page clv](#).

CONFIGURING A CONFERENCE KEY USING THE MITEL WEB UI



1. Click on **Operation > Softkeys and XML.**
or
Click on **Operation > Expansion Module <N>.**

Softkeys Configuration

Bottom Keys		Top Keys		
Key	Type	Label	Value	Line
1	Conference	Conf		1
2	None			1
3	None			1
4	None			1
5	None			1

Softkeys

2. Select from **Key 1** through **Key 20** on the Top keys.
or
Select from **Key 1** through **Key 18** on the Bottom keys.
3. In the **Type** field, select **Conference**.
4. In the **Label** field, enter a label to apply to this key.
5. In the state fields, check (enable) or uncheck (disable) the states you want to apply to this softkey.

Expansion Module Keys

6. Select from **Key 1** through **Key 16** (M680i) or **Key 84** (M685i).
7. In the **Type** field, select **Conference**.
8. Click **Save Settings**.

TRANSFER KEY

By default, the 6867i has a dedicated **Transfer** key. However, using the Mitel Web UI, you can assign the **Transfer** key to any key on the left or bottom keys on the phone.

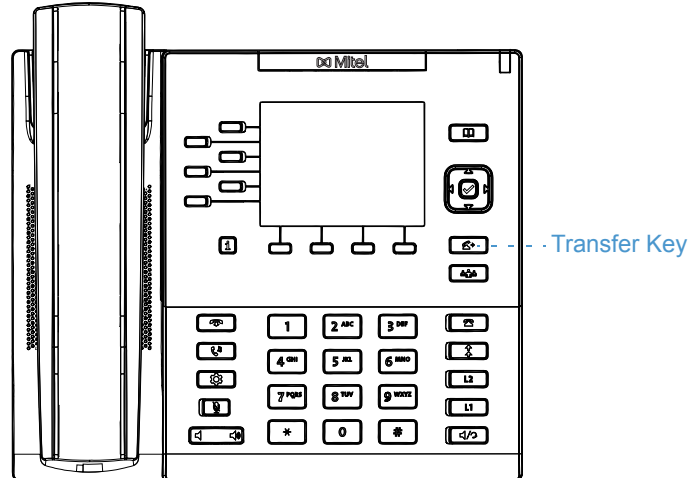

Note: For more information about transferring calls, see [“Transferring Calls”](#) on [page cl](#).

CONFIGURING A TRANSFER KEY USING THE MITEL WEB UI

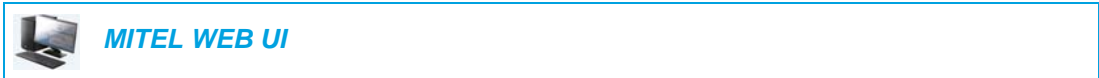

1. Click on **Operation > Softkeys and XML.**
or
Click on **Operation > Expansion Module <N>.**

Softkeys Configuration

Bottom Keys | Top Keys

Key	Type	Label	Value	Line
1	Transfer	Xfer		1
2	None			1
3	None			1
4	None			1
5	None			1

Softkeys

2. Select from **Key 1** through **Key 20** on the Top keys.
or
Select from **Key 1** through **Key 18** on the Bottom keys.
3. In the **Type** field, select **Transfer**.
4. In the **Label** field, enter a label to apply to this key.
5. In the state fields, check (enable) or uncheck (disable) the states you want to apply to this softkey.

Expansion Module Keys

6. Select from **Key 1** through **Key 16** (M680i) or **Key 84** (M685i).
7. In the **Type** field, select **Transfer**.
8. Click **Save Settings**.

INTERCOM KEY

You can use the **Intercom** key to automatically connect with a remote extension for outgoing calls, and to answer an incoming intercom call.



Note: For more information about the Intercom feature, see “Using Intercom Functionality” on page cxl.

CONFIGURING AN INTERCOM KEY USING THE MITEL WEB UI



MITEL WEB UI

1. Click on **Operation > Softkeys and XML**.
or
Click on **Operation > Expansion Module <N>**.

Softkeys Configuration

Bottom Keys		Top Keys		
Key	Type	Label	Value	Line
1	Icom	Icom		1
2	None			1
3	None			1
4	None			1
5	None			1

Softkeys

2. Select from **Key 1** through **Key 20** on the Top keys.
or
Select from **Key 1** through **Key 18** on the Bottom keys.
3. In the **Type** field, select **Icom**.
4. In the **Label** field, enter a label to apply to this key.
5. In the **Value** field, enter the predefined number you wish to be dialed when the Intercom key is pressed.



Note: If no value is defined, you will need to manually enter a number after pressing the Intercom key.

6. In the state fields, check (enable) or uncheck (disable) the states you want to apply to this softkey.

Expansion Module Keys

7. Select from **Key 1** through **Key 16** (M680i) or **Key 84** (M685i).
8. In the **Type** field, select **Icom**.

- In the Value field, enter the predefined number you wish to be dialed when the Intercom key is pressed.



Note: If no value is defined, you will need to manually enter a number after pressing the Intercom key.

- Click **Save Settings**.

PHONE LOCK KEY

You can configure a key on the IP phone to use as a lock/unlock key. You assign the function of the key as **Phone Lock**.

CONFIGURING A PHONE LOCK KEY



MITEL WEB UI

- Click on **Operation > Softkeys and XML**.
or
Click on **Operation > Expansion Module <N>**.

Softkeys Configuration

Bottom Keys | Top Keys

Key	Type	Label	Value	Line
1	Phone Lock			1
2	None			1
3	None			1
4	None			1
5	None			1

Softkeys

- Select from **Key 1** through **Key 20** on the Top keys.
or
Select from **Key 1** through **Key 18** on the Bottom keys.
- In the **Type** field, select **Phone Lock** from the list of options.

Expansion Module Keys

- Select from **Key 1** through **Key 16** (M680i) or **Key 84** (M685i).
- In the **Type** field, select **Phone Lock** from the list of options.
- Click **Save Settings**.



Note: You can lock/unlock the phone using the new key you just configured, using the Mitel Web UI at the path *Operation > Phone Lock*, or using the **Phone Lock** option on the IP phone UI at the path *Options > Lock > Phone Lock*. For more information about using the lock/unlock feature, see [“Locking the Phone Using the IP Phone UI”](#) on page Iviii.

PAGING KEY

You can configure a **Paging** key on the phone that allows you to send a Real Time Transport Protocol (RTP) stream to pre-configured multicast address(es) without involving SIP signaling. You enter a multicast IP address(es) and a port number for the Paging key, that when pressed, initiates an outgoing multicast RTP session. This is called Group Paging on the IP phones.

You can also specify group paging RTP addresses that the phone listens for when receiving RTP streams. You can specify up to 5 listening multicast addresses at the path, *Basic Settings > Preferences > Group Paging RTP Settings*.

For more information about Group Paging and how it works, and to specify multicast addresses, see “[Group RTP Paging](#)” on [page ccxi](#).

CONFIGURING A PAGING KEY USING THE MITEL WEB UI



MITEL WEB UI

1. Click on **Operation > Softkeys and XML**.
or
Click on **Operation > Expansion Module <N>**.

Softkeys Configuration

Bottom Keys		Top Keys		
Key	Type	Label	Value	Line
1	Paging	Group 1	239.0.1.15:10000	1
2	None			1
3	None			1
4	None			1
5	None			1

Softkeys

2. Select from **Key 1** through **Key 20** on the Top keys.
or
Select from **Key 1** through **Key 18** on the Bottom keys.
3. In the **Type** field, select **Paging**.
4. In the **Label** field, enter a label to apply to this key.
5. In the **Value** field, enter a multicast IP address and a port number for the **Paging** key. When you press this key, the phone initiates an outgoing multicast RTP session to the specified address using the specified port (e.g. 239.0.1.15:10000).



Notes:

1. When you select **Paging** for the **Type** field, the **Line** field is disabled.
 2. The **Value** field allows for one multicast address entry only.
6. To receive RTP streams for group paging, you must also configure the **Paging Listen Addresses** parameter at the path, *Basic Settings > Preferences > Group Paging RTP*

Settings. For more information about setting this parameter, see [“Group RTP Paging”](#) on [page ccxi](#).

Expansion Module Keys

7. Select from **Key 1** through **Key 16** (M680i) or **Key 84** (M685i).
8. In the **Type** field, select **Paging**.
9. In the **Value** field, enter a multicast IP address and a port number for the Paging key. When you press this key, the phone initiates an outgoing multicast RTP session to the specified address using the specified port. (For example, 239.0.1.15:10000).



Notes:

1. When you select **Paging** for the **Type** field, the **Line** field is disabled.
 2. The **Value** field allows for one multicast address entry only.
10. To receive RTP streams for group paging, you must also configure the **Paging Listen Addresses** parameter at the path, *Basic Settings > Preferences > Group Paging RTP Settings*. For more information about setting this parameter, see [“Group RTP Paging”](#) on [page ccxi](#).
 11. Click **Save Settings** to save your changes

USING THE PAGING KEY

The following procedure describes the use of the **Paging** key on the IP phone. The procedure assumes you have already configured the **Paging** key using the Mitel Web UI.



Notes:

1. The recipient of a paging call can set a global DND to ignore any incoming pages.
2. For incoming paging, the phone uses the Intercom configuration settings. The incoming page is dependent on the **Allow Barge In** parameter setting and the idling/on call state.



IP PHONE UI

1. On the IP phone, press the softkey or expansion module key you configured for **Paging**. The phone opens a multicast RTP session and an outgoing OR incoming phone screen displays.
2. Press the **Drop** key to end the multicast RTP session and return to the **Home** screen.



Note: If you enable global DND on the phone, the incoming multicast RTP session is dropped.

DISCREET RINGING KEY

You can configure a **Discreet Ringing** key on the phone that when pressed allows you to toggle on/off the Discreet Ringing feature. When the Discreet Ringing feature is enabled, if a call is incoming, the phone will play the configured ring tone once only. All applicable visual indicators (LED for the corresponding Line key, Message Waiting Indicator [MWI], etc...) will behave normally.



Note: If a custom ring tone is selected and Discreet Ringing is enabled, the phone will not play the custom ring tone during an incoming call. Ring tone 1 will be played once instead.

CONFIGURING A DISCREET RINGING KEY



MITEL WEB UI

1. Click on **Operation > Softkeys and XML.**
or
Click on **Operation > Expansion Module <N>.**

Softkeys Configuration

Bottom Keys		Top Keys		
Key	Type	Label	Value	Line
1	Discreet Ringing			1
2	None			1
3	None			1
4	None			1
5	None			1

Softkeys

2. Select from **Key 1** through **Key 20** on the Top keys.
or
Select from **Key 1** through **Key 18** on the Bottom keys.
3. In the **Type** field, select **Discreet Ringing**.
4. Click **Save Settings** to save your changes.

Expansion Module Keys

5. Select from **Key 1** through **Key 16** (M680i) or **Key 84** (M685i).
6. In the **Type** field, select **Discreet Ringing**.
7. Click **Save Settings** to save your changes.

CALL HISTORY KEY

In addition to the **Received Callers List** and **Outgoing Redial** keys, you can configure a **Call History** key on the phone that when pressed will directly access the list of all calls in the Call History.

Call History All - 6867i

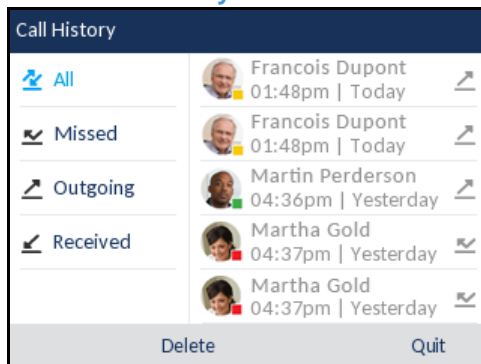

CONFIGURING A CALL HISTORY KEY USING THE MITEL WEB UI



1. Click on **Operation > Softkeys and XML**
or
Click on **Operation > Expansion Module <N>**

Softkeys Configuration

Key	Type	Label	Value	Line
1	Call History			global
2	None			1
3	None			1
4	None			1

Softkeys

2. Select from **Key 1** through **Key 20** on the Top keys.
or
Select from **Key 1** through **Key 18** on the Bottom keys.
3. In the **Type** field, select **Call History**.
4. In the **Label** field, enter a label to display on the phone for the key (default is "Call History").
5. Click **Save Settings**.

Expansion Module Keys

6. Select from **Key 1** through **Key 16** (M680i) or **Key 84** (M685i).
7. In the **Type** field, select **Call History**.
8. In the **Label** field, enter a label to display on the phone for the key (default is "Call History").
9. Click **Save Settings**.

EMPTY KEY

You can set a softkey to force a blank entry on the IP phone display for a specific key. You do this by setting the softkey to **Empty**. The keys are added in order (from key 1 to key 18 [bottom] or key 20 [top]) after any hard-coded keys have been added. If a particular key is not defined, it is ignored.

CONFIGURING AN EMPTY KEY USING THE MITEL WEB UI



MITEL WEB UI

1. Click on **Operation > Softkeys and XML**.
or
Click on **Operation > Expansion Module <N>**.

Softkeys Configuration

Bottom Keys		Top Keys			
Key	Type	Label	Value	Line	
1	Empty			1	
2	Empty			1	
3	Empty			1	
4	Empty			1	
5	Empty			1	

Softkeys

2. Select from **Key 1** through **Key 20** on the Top keys.
or
Select from **Key 1** through **Key 18** on the Bottom keys.
3. In the **Type** field, select **Empty**.
4. In the state fields, check (enable) or uncheck (disable) the states you want to apply to this softkey.

Expansion Module Keys

5. Select from **Key 1** through **Key 16** (M680i) or **Key 84** (M685i).
6. In the **Type** field, select **Empty**.
7. Click **Save Settings**.

NONE KEY

Use the following procedure to delete a key's functionality on the 6867i IP phone.

DELETING A KEY'S FUNCTION USING THE MITEL WEB UI

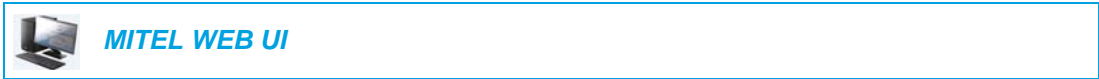

1. Click on **Operation > Softkeys and XML**.
or
Click on **Operation > Expansion Module <N>**.

Softkeys Configuration

Key	Type	Label	Value	Line
1	None			1
2	None			1
3	None			1
4	None			1
5	None			3

2. Choose the key you want to delete from the phone or expansion module.
3. In the **Type** field, select **None**.
4. Click **Save Settings**.
The key function is deleted from the IP phone memory.

MAKING CALLS

This section describes ways to make calls on your 6867i phone, using your handset, speakerphone or headset.

DIALING A NUMBER

First, take the phone off-hook by:

- Lifting the handset
- Pressing  or
- Pressing a line/call appearance button

At the dial tone, enter the number you wish to call.



Note: After dialing the number, the phone has a short delay before sending the call. To send the call immediately, you can press the **Dial** softkey (if the handset is offhook) or the **#** key immediately after dialing the number. The phone sends the call without delay.

If you are unable to make calls within certain area codes, check with your System Administrator for any toll restrictions placed on your extension that may restrict your access to long distance area codes or dialing prefixes.

When your party picks up, a timer appears on your display that records the length of your call.

If the **Live Dialpad** option is on, as soon as you press the first digit on the dialpad the phone automatically selects the next available line, goes off-hook, and dials as digits are pressed.

PRE-DIALING A NUMBER

You can also make a call by pre-dialing a number. Pre-dialing lets you view a number before you dial.







With the phone in an idle state and on-hook, simply use the dialpad to enter the number you wish to call, and after reviewing the number, press the **Dial** softkey. Use the **Backspace** softkey to correct any errors and the **Pause** softkey to insert pauses.

USING HANDSFREE SPEAKERPHONE

The handsfree feature allows you to speak to someone without using the handset or headset. Your phone must be in either the **Speaker** or **Speaker/Headset** audio mode. For more information about setting the audio mode on your phone, see “Audio Mode” on page lxiii.



- To dial using handsfree, first press  and enter a number at the dial tone.
- To answer a call on your phone using handsfree, press  or the line/call appearance button.
- If you are in **Speaker** audio mode, lift the handset and press  to switch between handsfree and handset.
- If you are in **Speaker/Headset** audio mode, press  to switch between handsfree and headset.
- When the handset is on hook, press  to disconnect the call.



Note: When handsfree is on, the speaker light turns on.

USING A HEADSET

The 6867i accepts analog and DHSG/EHS headsets through the modular RJ22/RJ45 port on the back of the phone or USB headsets through the USB port.

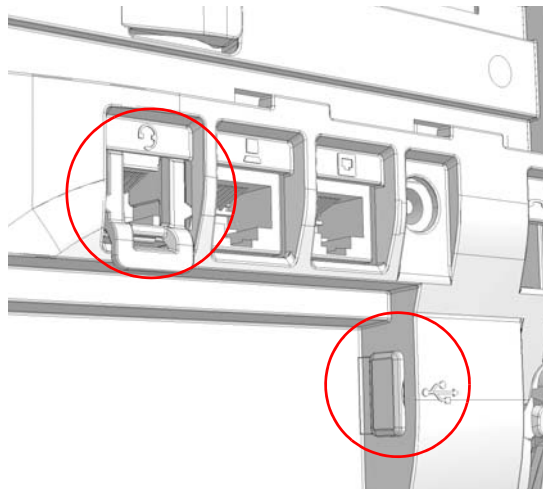

Contact your telephone equipment retailer or distributor to purchase a compatible headset.



Notes:

1. The RJ22/R45 headset port is for headset use only. Plugging any other devices into this port may cause damage to the phone and will void your warranty.
2. Customers should read and observe all safety recommendations contained in headset operating guides when using any headset.
3. Contact your System Administrator for questions regarding supported headsets.
4. If both an analog (non-DHSG) headset and a USB headset are connected to the phone, the USB headset will take precedence over the analog headset (i.e. the USB headset will be functional while the analog headset will not be functional).
5. If both a DHSG headset and a USB headset are connected to the phone and DHSG is enabled, the DHSG headset will take precedence over the USB headset.

VOLUME CONTROLS FOR THE HEADSET MICROPHONE

On the 6867i, there are three options for the headset microphone volume: **Low**, **Medium**, and **High**. For information about configuring the headset microphone volume, see “[Headset](#)” on [page lxiv](#).

MAKING AND RECEIVING CALLS USING A HEADSET





IP PHONE UI

1. Ensure that you have selected a headset audio mode (see “[Configuring the Audio Mode Using the IP Phone UI](#)” on [page lxiii](#)).
2. Turn the phone over and, depending on the type of headset, locate the headset jack marked f or the USB port.
 - a. If you have a USB headset, insert the USB plug into the USB port.
 - b. If you have a headset with an RJ9/RJ22 4-pin connector, insert the headset cord into the jack until it clicks into place.
 - c. If you have a DHSG/EHS headset with an RJ45 6-pin or 8-pin connector, remove the plastic headset jack adapter and then insert the cord into the jack until it clicks into place.



Note: See the *Mitel 6867i SIP IP Phone Installation Guide* for more information.



3. Press the  key to obtain a dial tone or to answer an incoming call. Depending on the audio mode selected from the Options List, a dial tone or an incoming call is received on either the headset or the handsfree speakerphone.
4. Press the  key to end the call.

USING INTERCOM FUNCTIONALITY

On the 6867i you can use the **Icom** key to automatically connect with a remote extension.

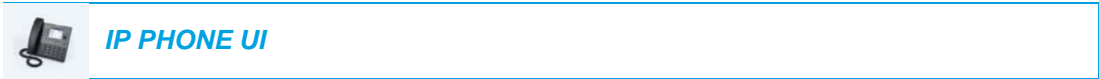
USING THE ICOM KEY



1. Press the **Icom** key.
2. If no number was defined when configuring the key, enter the extension number of the person you want to intercom.
3. After a beep tone, your phone automatically connects with the remote extension and you can speak through its speaker.
4. To cancel the intercom, press  or the **Cancel** key.
5. When you are finished speaking, hang up the phone by placing the handset back on-hook or by pressing  or the line/call appearance button for the active call. When you hang up, the remote phone also hangs up.

You can set specific incoming Intercom call features on the 6867i IP phone using the Mitel Web UI. The following table describes these features.

INCOMING INTERCOM FEATURES IN MITEL WEB UI	DESCRIPTION
Microphone Mute	Allows you to enable or disable the microphone on the IP phone for Intercom calls made by the originating caller.
Auto Answer	Allows you to enable or disable the IP phone to automatically answer an Intercom call. If auto-answer is enabled on the IP phone, the phone plays a tone (if Play Warning Tone is enabled) to alert the user before answering the intercom call. If auto-answer is disabled, the phone treats the incoming intercom call as a normal call.
Play Warning Tone	Allows you to enable or disable a warning tone to play when the phone receives an incoming intercom call on an active line.
Allow Barge In	Allows you to enable or disable how the phone handles incoming intercom calls while the phone is on an active call.

 **Note:** For more information about the incoming Intercom features and for procedures on setting these features, see [“Incoming Intercom Call Features”](#) on [page ccix](#).

OUTGOING REDIAL LIST



Note: Outgoing Redial List information in this User Guide describes the phone's native Outgoing Redial List. In some environments, the Outgoing Redial List key may bring up an Outgoing Redial List provided by the call manager; therefore, depending on your call manager, the Outgoing Redial List on your phone may function and behave differently than what is documented in this User Guide. If this is the case, contact your System Administrator for more information regarding your specific Outgoing Redial List.



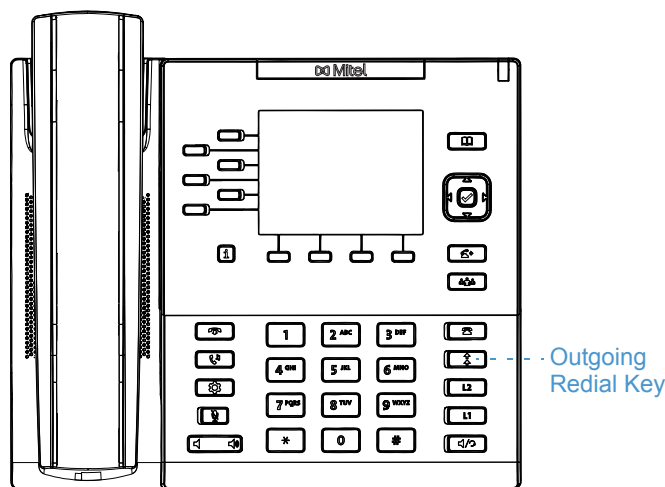

The Outgoing Redial List stores information for up to the last 100 numbers you called. Your phone logs the name/number of the called party, when you called, and if the call was answered or missed. Additional information such as the duration of the call, line used, and call features utilized during the call can also be viewed.

You can view, scroll, and delete line items in the Outgoing Redial List from the IP phone UI as well as copy selected entries to the Local Directory. You can also dial out directly using a displayed entry in the Outgoing Redial List.

On the 6867i, you access the Outgoing Redial List by the  key.



The following table identifies and describes the various icons displayed in the Outgoing Redial List.

ICON	DESCRIPTION
	Indicates an outgoing call.
CALL FEATURE INDICATORS (IN DETAILED VIEW ONLY)	
	Indicates the call was secured using TLS/SRTP encryption.
	Indicates the call was using Mitel Hi-Q™ audio.
	Indicates active VoIP recording was enabled and the call was recorded.



Notes:

1. When the Outgoing Redial List is full, the oldest call records are deleted to accommodate the information of new called parties.
2. If the telephone number of an incoming or outgoing call matches a number that you have programmed with a name in a softkey or the Directory, the Outgoing Redial List display the same name and number.
3. For details on the total number of Outgoing Redial List entries currently stored on your phone, see [“Phone Status via IP Phone UI”](#) on [page xxxii](#).

ACCESSING THE OUTGOING REDIAL LIST



1. Press once to access the **Outgoing Redial List**.

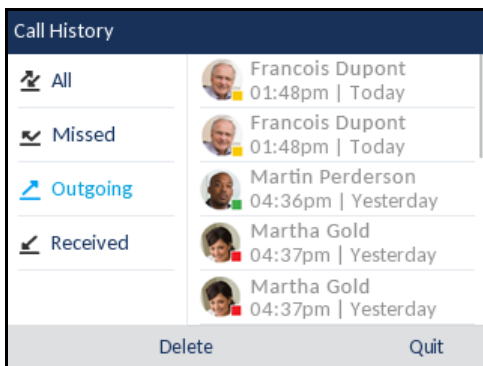

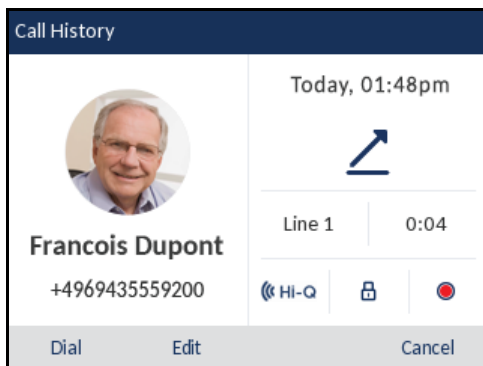

Note: Press twice to dial the most recent number you dialed from the phone.

2. With **Outgoing** highlighted press the key to move to entry column.
3. Use the and keys to scroll through the entries in the Outgoing Redial List.
4. Press to see more detailed information about the redial entry.







Note: The detailed view screen contains the picture ID of the called party (if available), the date and time of the outgoing call, the line on which the call was placed, call duration (if the call was answered), any applicable call feature indicators, and the caller ID details.

5. To dial the displayed number while in the Outgoing Redial List, press the  button, press , press the **Dial** softkey, lift the handset, or press any of the line keys.
6. To exit the Outgoing Redial List, press  or the **Quit** softkey.

EDITING ENTRIES IN THE OUTGOING REDIAL LIST

In the Outgoing Redial List, pressing the **Edit** softkey allows you to edit the entry's name and/or number prior to dialing out or copying to the Local Directory.



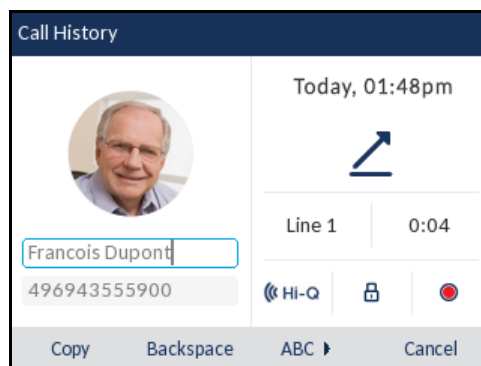

1. Press the  key.
2. With **Outgoing** highlighted press the  key to move to entry column.
3. Use the  and  keys to scroll through the entries in the Outgoing Redial List.
4. Press  to see more detailed information about the Outgoing Redial List entry.
5. Press the **Edit** softkey.



6. Using the dialpad keys, edit the name and/or number.



Note: To move the cursor one digit/character to the right, press the  navigation key. To erase one digit/character to the left of the cursor, press the **Backspace** softkey.

7. To dial the new number, press the  button, press , lift the handset, or press any of the line keys
or
8. To copy the new number to the Local Directory, press the **Copy** softkey.

DELETING ALL ENTRIES IN THE OUTGOING REDIAL LIST

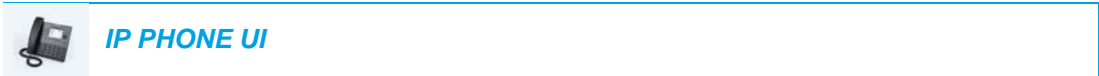



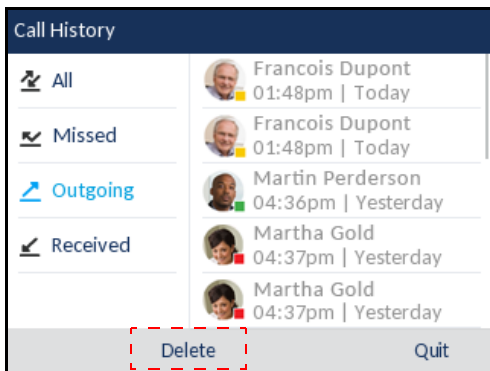

1. Press  once to access the **Outgoing Redial List**.
2. Press the **Delete** softkey.



3. Press the **Delete** key to erase all items.

DELETING AN ENTRY IN THE OUTGOING REDIAL LIST



1. Press  once to access the **Outgoing Redial List**.
2. With **Outgoing** highlighted press the  key to move to entry column.
3. Use the  and  keys to scroll through the entries in the Outgoing Redial List.
4. Press the **Delete** softkey.

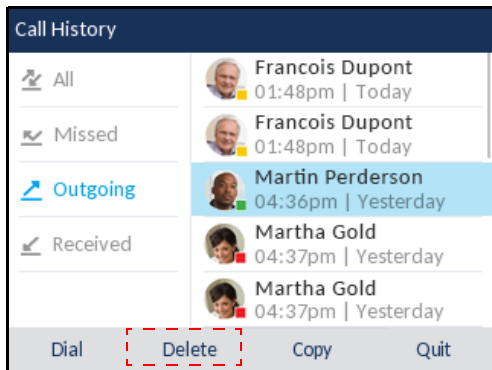





5. Press the **Delete** softkey again to erase the entry.

COPYING ENTRIES TO THE LOCAL DIRECTORY



IP PHONE UI

1. Press the  key.
2. With **Outgoing** highlighted press the  key to move to entry column.
3. Press the  and  navigation keys to scroll through and highlight the respective Outgoing Redial List entry.

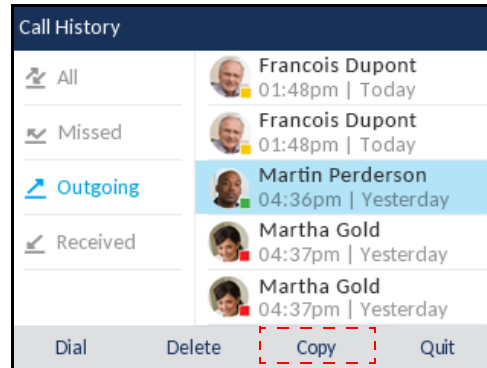





4. Press the **Copy** softkey.
The entry is copied to the Directory.



Note: If the contact's name already exists in the Directory but the number is different, press the **Replace** softkey to replace the contact's old number with the new number or press the **Merge** softkey to add the new number as an additional number while keeping the old number intact.

MUTE

You can use the  key to mute the handset, headset, or speakerphone. When you use the  key on your phone, you cannot be heard on an active call or on a conference. For muted calls, the handsfree LED flashes and the  key LED is on. To switch mute on or off, press .



Note: If you place a muted call on hold, the phone automatically takes the call off mute when you reconnect to the call.

RECEIVING CALLS

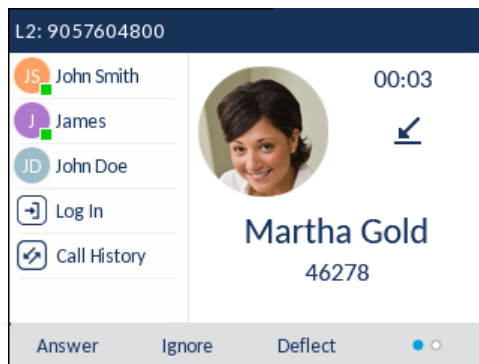

When a call is ringing at your extension, the inbound callers name, extension, picture ID (if applicable), and incoming call icon display on the screen. Additionally, the line/call appearance LED flashes quickly for the incoming call.

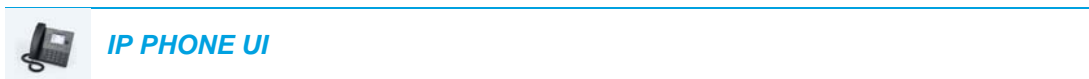

Note: You can press the Silence softkey (on the second page of the bottom softkeys) when the phone is ringing to immediately silence the ring tone.

ANSWERING AN INCOMING CALL



- For handsfree operation, press , the **Answer** softkey, or the line/call appearance button for the incoming call.
- Press  for headset operation or the answer button on your headset (if available).
- Lift the handset for handset operation.



Note: The audio mode setting you have selected in *Options List > Headset Settings* on the IP phone UI determines if the call goes to handsfree or headset operation. For more information, see the section [“Audio Mode”](#) on [page lxiii](#)

If the phone is already connected to a call, pressing the line/call appearance button or **Answer** softkey for the new incoming call automatically places the connected call on hold and answers the new call.



Note: If the Goodbye Key Cancels Incoming Call feature is disabled, you can also use the answer button on your headset (if available) to answer the secondary incoming call. If the Goodbye Key Cancels Incoming Call feature is enabled, the answer button on your headset will cancel the secondary incoming call. For more information on the Goodbye Key Cancels Incoming Call feature, see the section [“Goodbye Key Cancels Incoming Calls”](#) on [page ccvii](#).

To reconnect to a party, press the line/call appearance button for that call or navigate to the call on hold and press the **Pickup** softkey. If you cannot answer the call, the caller goes to voicemail (if voicemail has been configured for your extension).



Note: The  key can be used to cancel the call pickup procedure.

DEFLECTING AN INCOMING CALL

While call forwarding allows you to forward calls to a pre-defined number, and whereby most call transfers requires you to first answer the incoming call, call deflection allows you to manually determine, while a call is incoming, what the destination number should be.

You can enter a destination number using the dialpad keys or deflect a call quickly to a programmable key or softkey configured with Speeddial or BLF functionality. Applicable key types include:

- Speeddial
- Speeddial/Xfer
- Speeddial/Conf
- Speeddial/MWI
- BLF
- BLF/Xfer



Notes:

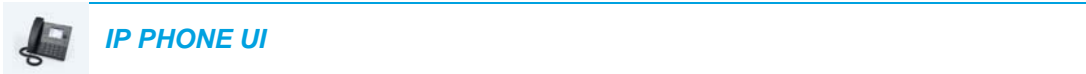

1. Live dialpad is disabled when entering destination numbers using the call deflection feature.
2. When the "No Answer" Call Forward mode is configured and enabled on the phone, incoming calls will not be forwarded to the defined "No Answer" number if you are in the process of deflecting the incoming call.

For example, during an incoming call, with the "No Answer" Call Forward mode configured to forward incoming calls after five rings, if you press the **Deflect** softkey and in the process of deflecting the call five rings elapse, the call will not be forwarded. This is true even if you decide not to deflect the call and cancel the deflection process after five rings. However, if you cancel the deflection process before five rings, the call will be forwarded per usual.



1. During an incoming call, press the **Deflect** softkey.
 2. Using the dialpad keys, enter the destination number to which you wish to deflect the incoming call
or
Press a softkey key configured with Speeddial or BLF functionality.
-
-  **Note:** Use the **Backspace** softkey to correct any errors and the **Cancel** softkey to cancel the call deflection process.
3. If a destination number was entered manually, press the **Deflect** softkey again to deflect the call.

SENDING AN INCOMING CALL TO VOICEMAIL

You can send an incoming call directly to voicemail without answering the call. To do this, press  without picking up the handset or press the **Ignore** softkey. If you are already on the phone your incoming call should go directly to voicemail. Your phone screen displays a voicemail icon  displaying the number of pending messages.

HANDLING CALLS

When you are connected to a call, you can use the softkeys or hard keys on the phone to place a call on hold, transfer a call, or create a conference call.

PLACING A CALL ON HOLD

You can place an active call on hold by pressing the  key. When you place a call on hold, only your phone can retrieve the call.

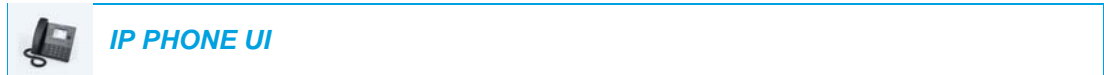

1. Connect to the call (if not already connected).
2. Press the  key.

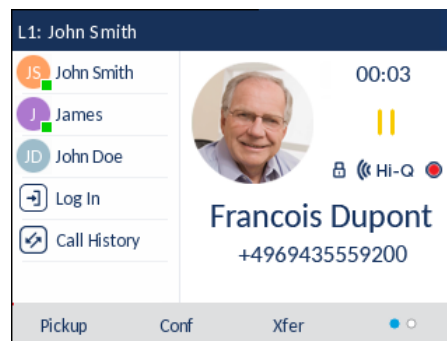

The screen displays the  icon indicating the call is on hold. Additionally, the line/call appearance light begins to flash slowly and after a short time the phone beeps softly to remind you that you still have a call on hold.



Note: If you are connected to another call, the phone does not beep to remind you that you still have a call on hold.



WHEN ON HOLD



To let your caller know that they are still on hold, music plays softly (if this has been set up for your system). The call/line appearance light for the line you are on remains solid to indicate that you are still connected.



AUTOMATIC HOLD

When juggling between calls, you do not have to press the  button to go from one call to the next. The phone automatically puts your current call on hold as soon as you press a new line/call appearance button.

RETRIEVING A HELD CALL

If you have more than one call on hold, you can reconnect to a held call by pressing the line/call appearance button where that call is being held or by navigating to the call on the **Line Selection** or any **Call** screen and pressing  or **Pickup** softkey. Press  or the **Drop** softkey to disconnect the call.

If an attempt to retrieve a held call fails, the 6867i displays a "Server Error" message and error reason code on screen (e.g. "Server Error: 408" for a Request Timeout or "Server Error: 503" for a Service Unavailable). You can disconnect the call on hold by pressing the  key in certain circumstances. A call on hold can be disconnected by pressing the  key only when these three conditions are met:

- The line with the call on hold is the line in focus.
- You have attempted to retrieve the call on hold by navigating to the call on the **Line Selection** or any **Call** screen and pressing the  or **Pickup** softkey.
- The attempt to retrieve the call on hold failed due to a 408, 5xx, or 6xx reason code. If the attempt failed due to a different server error reason, pressing the  key will not disconnect the call.

This behavior is applicable to all call-on-hold scenarios such as single point-to-point calls, conference calls, and any transfer scenarios. In an attended transfer scenario, pressing the  key after a failed retrieval attempt (that meets the above three conditions) will disconnect the call on hold instead of launching the transfer.

TRANSFERRING CALLS

The 6867i IP phone has a dedicated **Transfer** key. You can use this hard key to transfer calls or use the **Xfer** softkey offered on screen when in a connected call.

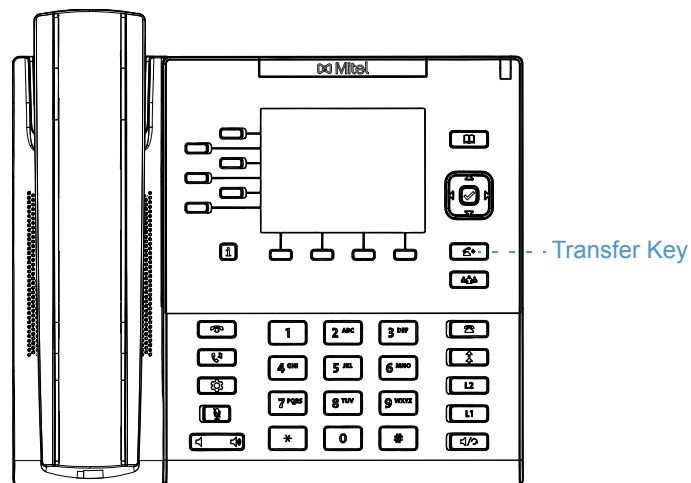

BLIND TRANSFER

A blind transfer is when you transfer a call directly to another extension without consulting with the person receiving the call. To do this, simply complete the transfer immediately after you

have entered the number. The call goes directly to the extension or outside line you transferred to.

CONSULTATIVE TRANSFER

You also have the option to consult with the person you are transferring the call to, before you complete the transfer. To do this, simply remain on the line until the receiving party answers the call. After consulting with the receiving party, you can either complete the transfer or cancel the transfer to go back to the original call.

DIRECT TRANSFER

The 6867i IP phone provides a convenient direct method of transferring an existing call to another existing call. If you have the transfer recipient on hold on another line, you can simply navigate to the recipient and press the  key or **Xfer** softkey and the direct transfer will be performed.

TRANSFERRING CALLS

Use the following procedure to transfer a call to another extension.

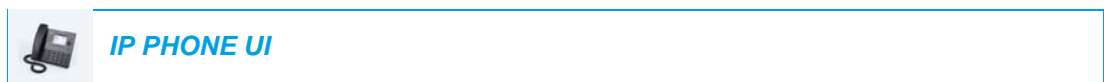

1. Connect to Party 1 (if not already connected). Party 1 is the party you want to transfer.

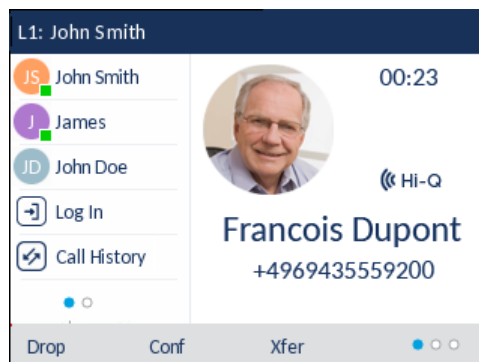



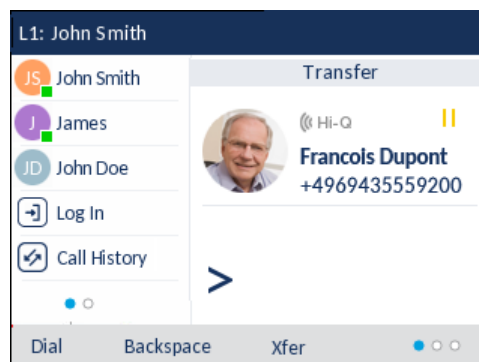

2. Press the  key or **Xfer** softkey.

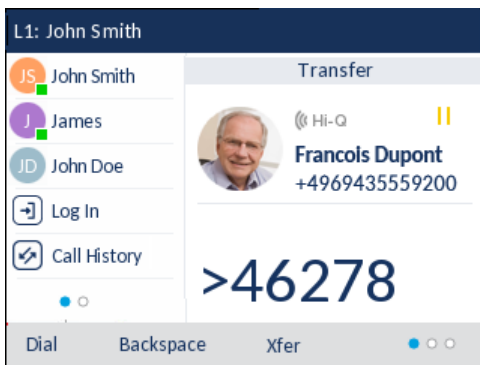

3. Enter the extension number (or the outside number) to Party 2.



To cancel the transfer you can either press the **Cancel** softkey on the display screen, press , or hang up the handset.

4. Complete either a blind or consultative transfer:
 - a. To complete a blind transfer, press the  key or **Xfer** softkey key again before the receiving end answers.
 - b. To complete a consultative transfer, press **Dial** and remain on the line to speak with the Party 2, before either pressing the  key, **Xfer** softkey,  key, or hanging up the handset to transfer Party 1 to Party 2.

TRANSFERRING AN EXISTING CALL TO ANOTHER EXISTING CALL



1. Ensure you are on an active call with the party you wish to transfer (the transfer recipient should be placed on hold).

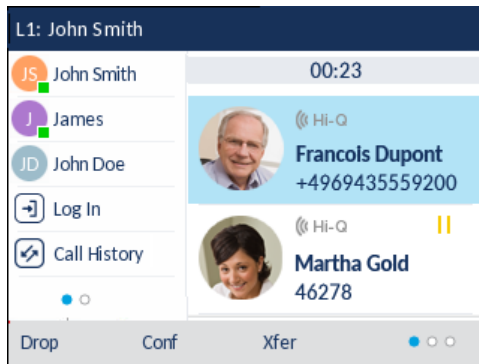

Note: Direct transferring can be performed in either the **Multi-View Call** screen or **Detailed View Call** screen.

- Press the ▲ and ▼ navigation keys to highlight the party to whom you wish to transfer the active call.

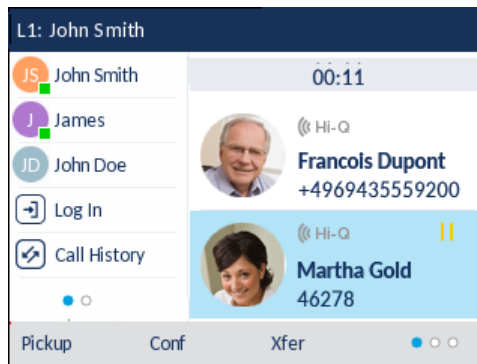

- Press the  key or **Xfer** softkey. The active call will be transferred.

TRANSFERRING TO A CONTACT IN THE DIRECTORY

Users can complete a transfer to a contact in their local Directory. If a user is in a call and initiates a transfer, they can navigate to the Directory screen and use the  key to complete a blind or consultative transfer.



- Connect to Party 1 (if not already connected). Party 1 is the party you want to transfer.

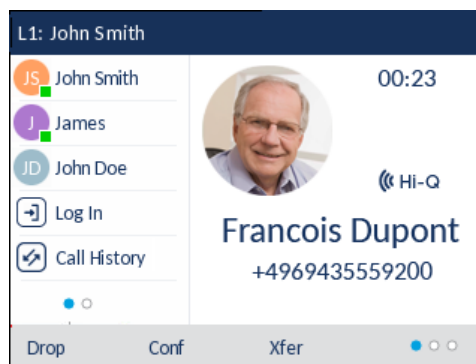

2. Press the  key or **Xfer** softkey.

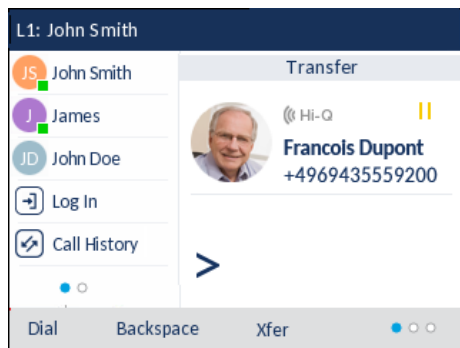

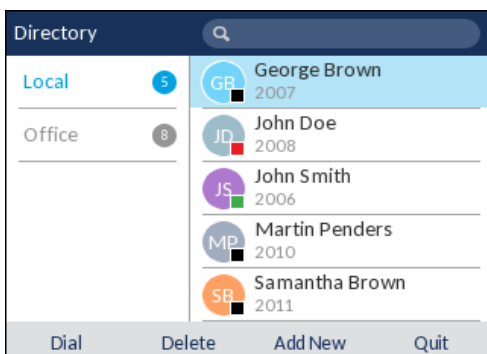

3. Press the  key and highlight a directory entry (or the desired number if the entry contains more than one number).



Note: If you have any additional Directory sources configured, you will need to first navigate to the desired Directory folder and then highlight the respective entry or number.

4. Complete either a blind or consultative transfer:

- a. To complete a blind transfer, press the  key.
- b. To complete a consultative transfer, press the  button to call the contact. Remain on the line to speak with Party 2 before pressing the  key or **Xfer** softkey again to transfer Party 1 to Party 2.

To cancel the transfer, press the **Cancel** softkey on the display screen or press .

INDICATION OF TRANSFERRED CALLS

When you transfer an active call, the near-end phone displays a **Call Transferred** screen when a call is transferred and the far-end call is dropped. The figure below illustrates the **Call Transferred** screen on the 6867i phone.

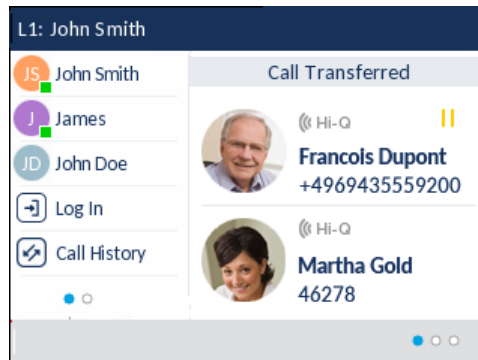

CONFERENCING CALLS

The 6867i IP phone has a dedicated **Conference** key. You can use this hard key to create conference calls or use the **Conf** softkey offered on screen when in a connected call.

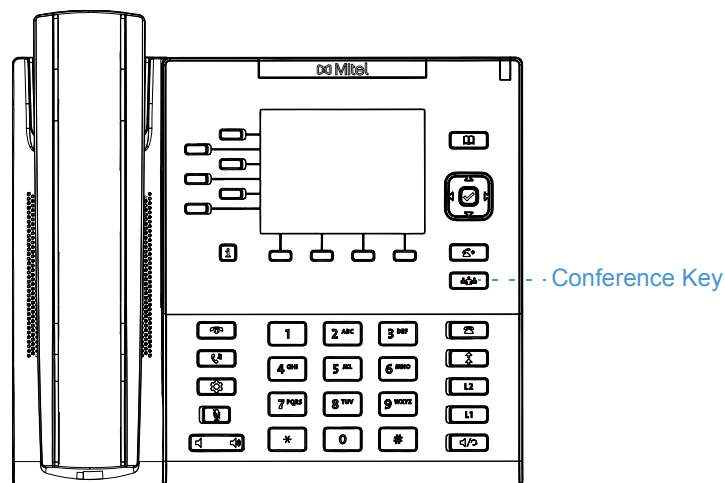

The 6867i IP phone offers two methods of conferencing:

- Local conferencing (default method).
- Centralized conferencing (for Sylanro and BroadSoft call managers - Administrators must enable this method).

LOCAL CONFERENCING

The 6867i phone supports up to three parties (including yourself) in a conference call. This is called local conferencing and is the default method of conferencing on the 6867i.



Note: Your System Administrator can set your **Conference** key to speed dial a specific number. Contact your System Administrator for more information.

Creating a Conference Call Using Local Conferencing

Use the following procedure to create a conference call using local conferencing.

 **IP PHONE UI**

1. When you begin a conference, you are the first party in the conference (Party 1). Pickup the handset or press the  key. A line opens up.
2. Call Party 2 by dialing their number (or answer an incoming call of a party).
3. Wait for Party 2 to answer. When Party 2 answers, you can consult with them before adding them to the conference.



4. Press the  key or **Conf** softkey.

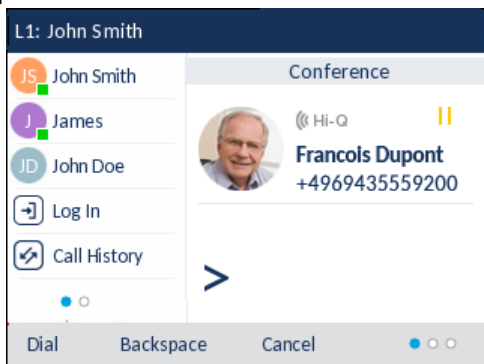

5. Enter the phone number of Party 3.

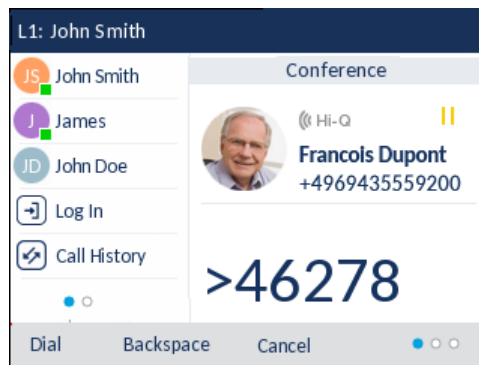

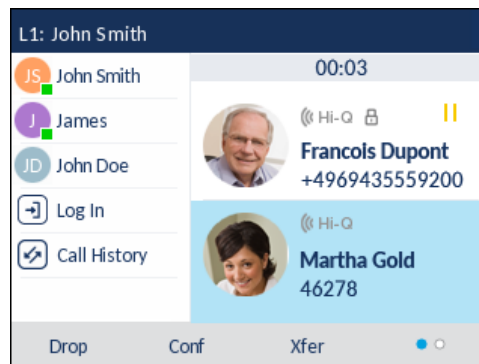

6. Wait for Party 3 to answer. When Party 3 answers, you can consult with them before adding them to the conference.

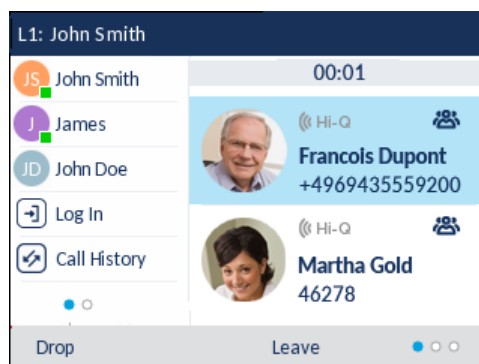

7. Press the  key or **Conf** softkey again to add Party 3 to the conference. Party 2 and Party 3 will connect with you to form a conference call.



8. To drop a party from the conference, use the  and  navigation keys to highlight the desired party and press the **Drop** key.

Creating a Conference Call by Joining Two Existing Calls

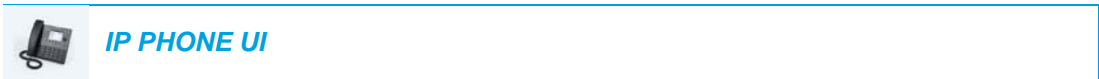

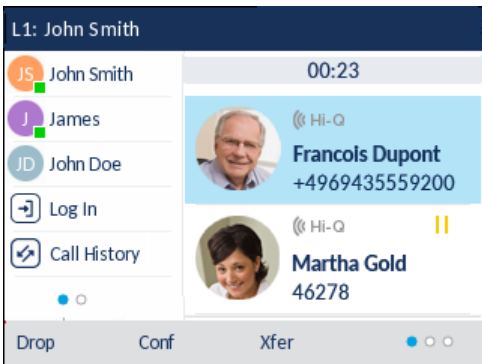

1. Ensure you are on an active call with one of the parties with whom you wish to create a conference (the other party should be placed on hold).

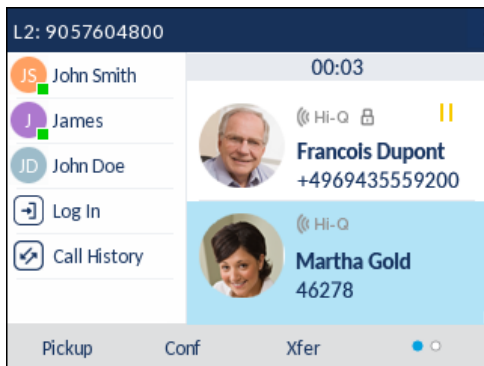

Note: Direct conferencing can be performed in either the **Multi-View Call** screen or **Detailed View Call** screen.

2. Press the ▲ and ▼ navigation keys to highlight the party you wish to conference in.



3. Press the  key or **Conf** softkey. The two parties will connect with you to form a conference call.

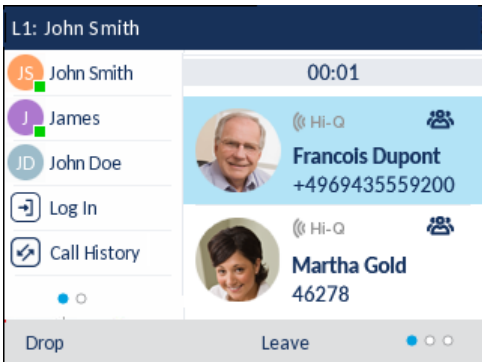

CENTRALIZED CONFERENCING (FOR SYLANTRO AND BROADSOFT CALL MANAGERS)

The 6867i allows you to create multiple conferences with unlimited participants (depending on your server limitations) when your Administrator enables centralized conferencing.

If your Administrator does not enable centralized conferencing, then the 6867i uses local conferencing by default.

Your Administrator can configure centralized conferencing globally on all lines or on specific lines. Although, for the global setting to work, you must configure the lines with the applicable phone number.







Note: When centralized conferencing is enabled on your phone, local conferencing (or three-way conferencing) works as indicated in “[Local Conferencing](#)” on [page clvi](#). Joining two active calls in a conference also works as indicated in “[Creating a Conference Call by Joining Two Existing Calls](#)” on [page clviii](#).

Setting Up a Conference and Adding Multiple Parties (for Sylantra and BroadSoft Call Managers)



IP PHONE UI

1. When you begin a conference, you are the first party in the conference (Party 1). Pickup the handset or press the  key. A line opens up.
2. Call Party 2 by dialing their number (or answer an incoming call of a party).
3. Wait for Party 2 to answer. When Party 2 answers, you can consult with them before adding them to Conference 1.
4. Press the  key or **Conf** softkey. A new line opens.
5. Enter the phone number of Party 3.
6. Wait for Party 3 to answer. When Party 3 answers, you can consult with them before adding them to the Conference 1.
7. Press the  key or **Conf** softkey again to add Party 3 to Conference 1. Party 2 and Party 3 will connect with you to form a conference call.
8. Press an available **Line** key or navigate to the **Line Selection** screen to place a new call using an available line (or answer an incoming call on an available line). If calling out, call Party 4.
9. Wait for Party 4 to answer. When Party 4 answers, you can consult with them before adding them to the conference.
10. Press the  key or **Conf** softkey.
11. Press the **Line** key or navigate to the **Line Selection** screen and highlight the line that has Conference 1.
12. Press the  key or **Conf** softkey to join all parties (Parties 1 through 4) on Conference 1.

13. To add more parties, repeat steps 8 through 12.

If any party in the conference hangs up (including the party that began the conference), all other parties in the conference are still connected.



Setting Up Multiple Conferences (for Sylantró Call Manager only)



Note: The 6867i is limited to 24 conferences (a single conference each on lines 1 through 24).



IP PHONE UI

1. Start Conference 1 using the procedures in the previous section, “[Setting Up a Conference and Adding Multiple Parties \(for Sylantró and BroadSoft Call Managers\)](#)” on [page clx](#).
2. When you are finished adding all required parties to Conference 1, press an available **Line** key or navigate to the **Line Selection** screen to place a new call using an available line to start Conference 2. You are Party 1 on Conference 2. Call Party 2.
3. When Party 2 answers, press the  key or **Conf** softkey.
4. Press an available **Line** key or navigate to the **Line Selection** screen to place a new call using an available line.
5. Call Party 3 for Conference 2.
6. When Party 3 answers, press the  key or **Conf** softkey to join Party 2, Party 3, and yourself to form a conference call. You now have two active conferences on two different lines.



Note: When you are connected to multiple conference calls and you put a conference on hold, the conference may be on hold for a limited period of time before it is disconnected. Contact your System Administrator for more information.



If any party in a conference hangs up (including the party that began the conference), all other parties in the conference are still connected.

Joining Additional Parties to Active Conferences

In centralized conferencing, you can join multiple incoming or outgoing calls to active conferences. Before following this procedure, at least one active conference must exist on your phone.



IP PHONE UI

1. As Party 1, pickup the handset or press the  key.
A line opens up.
2. Call Party 2 by dialing their number (or answer an incoming call of a party).
3. Wait for Party 2 to answer. When Party 2 answers, you can consult with them before adding them to the conference.
4. Press the  key or **Conf** softkey.
5. Press the **Line** key that contains the active conference or highlight a party that is part of the active conference and press the  key or **Conf** softkey again to join the parties to the active conference. For example, Line 1 and Line 2 both have active conferences. Pressing Line 1 or highlighting a party from Line 1 will join Party 1 and Party 2 to the conference on Line 1. Pressing Line 2 or highlight a party from Line 2 will Party 1 and Party 2 to the conference on Line 2.

ENDING A CONFERENCE AND TRANSFERRING REMAINING PARTIES

The 6867i allows a host to easily leave a three-way conference call without disrupting the connection of the other two remaining parties. If you are the host of a conference call and want to leave the conference, simply press the **Leave** softkey on the phone. Your phone leaves the three-way conference call but the remaining parties are still connected together.

ENDING CALLS



IP PHONE UI

To end a call, you first need to connect or reconnect to the call if not already connected (e.g. if your caller is on hold). Press  or the **Drop** softkey to end the call. If connected through the handset, you can also place the handset back on hook to end the call.

MANAGING CALLS

The 6867i has several features that make it easier to manage calls, and to keep track of your caller history, as well as your business and personal contacts.

These features include:

- Directory
- Received Callers List
- DND and Call Forward

DIRECTORY

The Directory is your personal phone book, conveniently stored within your phone. The 6867i IP phone supports enhanced Directory functionality allowing for interoperability with multiple directory sources (i.e. Local Directory, Corporate and Personal CSV directories, LDAP, Microsoft Exchange, Xsi Enterprise Directory, Xsi Personal Contacts, Xsi Enterprise Common Phone List, Xsi Group Directory, and Xsi Group Common Phone List).

On the 6867i, you access the Directory by the  key.

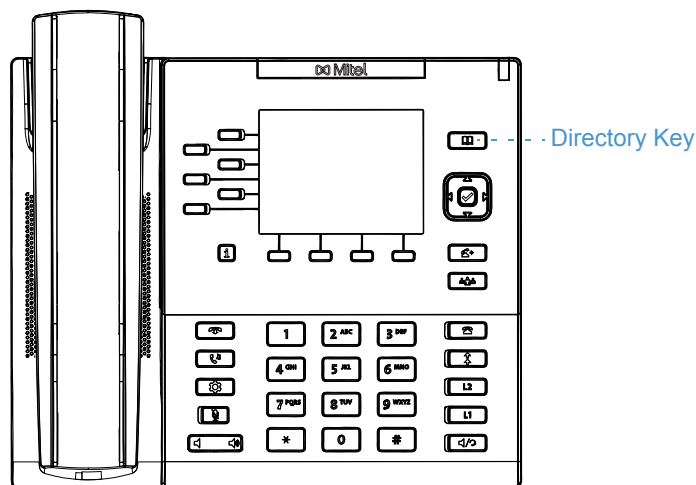

Notes:

1. As stated above, the 6867i IP phone supports enhanced Directory functionality. Your Local Directory will always be available, while the availability of all other Directory sources is dependent on what has been configured by your Administrator.
2. See “[Directory](#)” on page liii for information on how to configure various Directory options.
3. See “[Credentials](#)” on page lvi for information on how to input your user credentials for respective Directory sources and test connections to the Directory source(s).

GENERAL DIRECTORY FUNCTIONS

Accessing and Navigating the Directory (No External Sources Configured/Enabled)



1. Press the softkey. If no external Directory sources are configured or enabled, the local Directory is displayed as per the following image.

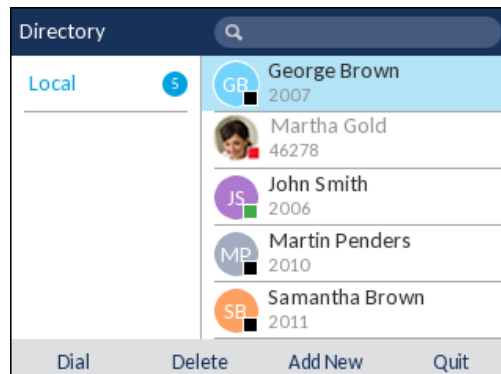

Note: If the Directory is empty, a **Directory empty** message displays.

2. You can view entry details by pressing the and navigation keys to scroll through the list.
3. From the number selection column, press the navigation key to display the contact's details screen.

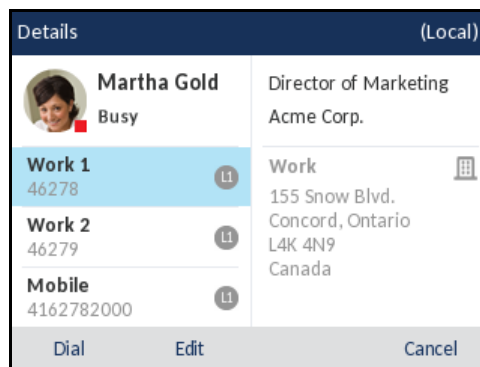

You can use the and navigation keys to scroll through the list of numbers or press the navigation key to move to the address column and scroll through the contact's addresses using the and navigation keys.

4. Press the softkey configured with Directory functionality, key, or **Quit** softkey to exit.

Accessing and Navigating Your Directory (External Directory Sources Configured/Enabled)



1. Press the softkey. If additional external Directory sources are configured and enabled, the Directory screen encompasses the different source folders as per the following image.

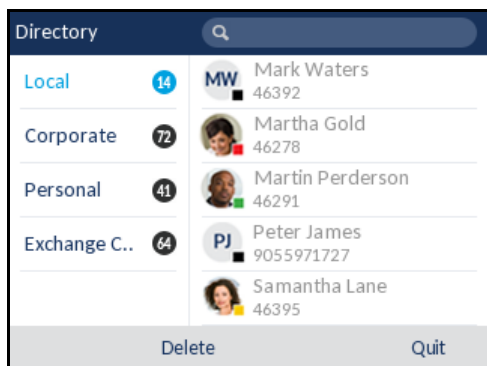

Note: If the Directory is empty, a **Directory empty** message displays.

2. You can view the list of Directory entries on the right for each respective folder by pressing the and navigation keys.
3. Press the navigation key to move to the entry column. From this column, you can use the and navigation keys to scroll through the list of entries.
4. From the entry column, press the navigation key to display the contact's details screen.

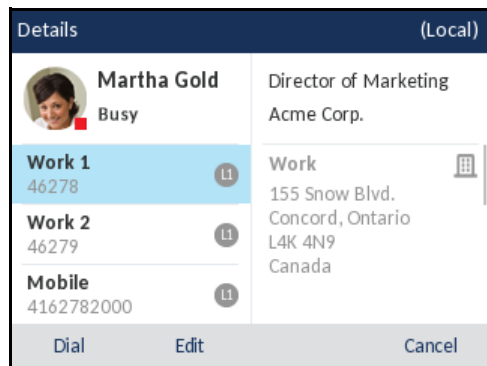

You can use the and navigation keys to scroll through the list of numbers or press the navigation key to move to the address column and scroll through the contact's addresses using the and navigation keys.

5. Press the softkey configured with Directory functionality, key, or **Quit** softkey to exit.

Performing a Search

Search functionality is applied across all the available and enabled directories. Pressing on any dialpad key initiates the search. After entering the first few letters of the contact's first name, last name, or company name, you can then quickly select a contact and perform the desired action. If external Directory sources are configured and enabled, you can select a contact from the consolidated "All" folder to perform an action, or navigate to the contact in the specific Directory folder to perform the desired action.

Use the following procedure on the phone's UI to perform a search.



Note: Depending on how your Administrator has configured the search functionality, you may need to press a **Search** softkey in order to execute the search function.



IP PHONE UI

1. Press the  softkey.
2. Using the dialpad keys enter in the letters of the desired contacts' first name, last name, or company name.
 If no external Directory sources are configured or enabled, search matches will be displayed on the left column with any additional numbers for the respective contact displayed on the right.
 If external Directory sources are configured and enabled and the search finds multiple matches, the entry will be displayed in the **All** folder.

No External Sources

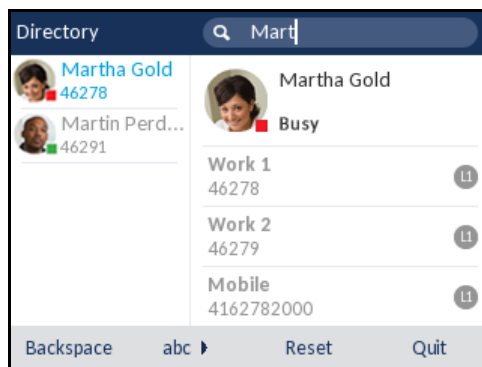

External Sources

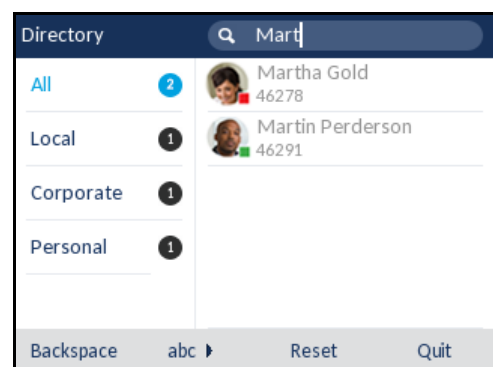



When matches are found, navigate to the contact entry and perform your desired action.



Notes:

1. If there is only one match, the contact will be displayed in the respective directory folder.
2. Press the **Reset** softkey at any time clear the search field.

Dialing from the Directory

Dialing can be performed by manually navigating to the Directory contact, selecting a phone number (if the contact has more than one) and then pressing the Dial softkey,  button, Line button,  button, or by simply pick up the handset.

Use the following procedure on the phone's UI to dial a contact's phone number.



1. Press the softkey.
2. (Optional) Using the dialpad keys input the first letters of the contact's name to initialize the search function.
3. Use the navigation keys to highlight the contact you want to call.

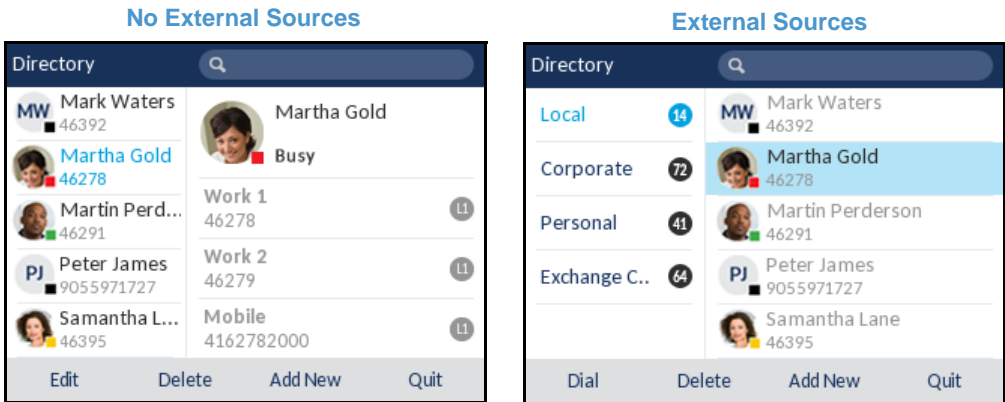

(Optional) If the contact has multiple phone numbers defined, press the key to navigate to the numbers selection column (if no external Directory sources are configured/enabled) or Details page and use the and keys to select the desired phone number.

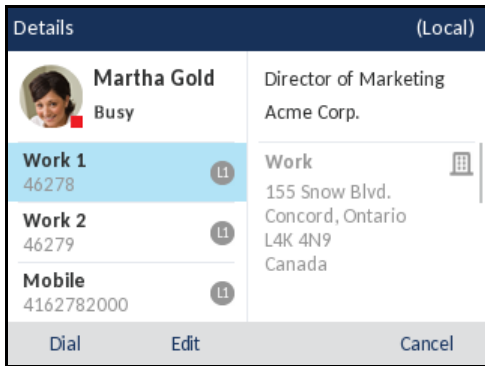

4. Press the Dial softkey, button, Line button, button, or pick up the handset to dial the contact's phone number.

LOCAL DIRECTORY FEATURES

The internal Local Directory contains the contacts that have been created or copied directly to the phone using the phone UI. If no external directory sources are available, pressing on the Directory key will open the Local Directory menu.



WARNING: WHEN UPGRADING A PHONE TO RELEASE 5.0.0 FROM A FIRMWARE VERSION PREVIOUS TO 4.0.0, ALL LOCAL DIRECTORY ENTRIES WILL BE MIGRATED ACCORDINGLY. HOWEVER, IF DOWNGRADING BACK TO A FIRMWARE VERSION PREVIOUS TO RELEASE 4.0.0, ALL LOCAL DIRECTORY ENTRIES WILL BE LOST. IF YOU PLAN ON DOWNGRADING AT ANY TIME IN THE FUTURE AND WOULD LIKE TO RETAIN YOUR LOCAL DIRECTORY INFORMATION, IT IS RECOMMENDED TO SAVE YOUR LOCAL DIRECTORY ENTRIES BEFORE ANY UPGRADE OR DOWNGRADE BY USING THE PHONE'S WEB UI UNDER THE *OPERATION > DIRECTORY* MENU SEE ["DOWNLOADING THE LOCAL DIRECTORY TO YOUR PC"](#) ON PAGE CLXXIII FOR DETAILS.

From the Local Directory menu, you can search for a contact, place a call to the selected contact, add new contacts to the Local Directory, delete all contacts, delete individual contacts, or edit existing contacts. Users can also view contact details (e.g. title, company name, numbers, work and home addresses, e-mail addresses, etc...).



Notes:

1. Up to 1000 Directory contacts can be stored locally on the phone.
2. For details on the total number of Local Directory entries currently stored on your phone, see ["Phone Status via IP Phone UI"](#) on page xxxii.

You can also assign an individual contact ring tone to contacts in your Local Directory. Individual contact ring tones can be used during incoming calls to help you identify the party calling. You can select contact-specific ring tones (from the phone's 15 preloaded as well as the 8 custom ring tones) for respective contacts in your Local Directory, which will be played back when a call from the respective contact is incoming.

Individual contact ring tone support is dependent on the phone's directory lookup functionality. During an incoming call, the Local Directory is examined against the phone number of the incoming call. If a match is found and the contact has an associated contact ring tone, the contact ring tone is played. If a match is not found or if a contact ringtone is not assigned, the standard ring tone for the line being used to field the incoming call is played.



Notes:





1. In instances where a custom ring tone is selected as the individual contact ring tone for a Local Directory contact and subsequently the custom ring tone is deleted, the standard ring tone will be played.
2. Downgrading to a firmware lower than Release 5.0.0 and then upgrading back to Release 5.0.0 or greater will cause the individual contact ring tone settings to be lost.
3. Individual contact ring tone support is applicable to the Local Directory only. If you would like to apply a ring tone for a contact in an external directory source (e.g. CSV-based directories, Exchange Contacts, LDAP, and Xsi directories) or Incoming Callers List/Outgoing Redial List, you must first copy the desired contact to the Local Directory.

Using the IP phone UI you can perform the following actions with regards to the Local Directory:



- Add new contacts to the Local Directory
- Edit entries in the Local Directory
- Delete all entries from the Local Directory
- Delete individual entries from the Local Directory

Adding New Entries to the Local Directory



1. Press the  softkey.
2. If no external sources are configured, simply press the **Add New** softkey.
or
If external Directory sources are configured/enabled and if the Local Directory contains contacts, press the  key to move to Local Directory contact column and press the **Add New** softkey.
3. Under the **Identity** tab, use the  and  keys to navigate to the desired fields and using the dialpad keys input the first name, last name, job title, and organization of the respective contact.

A screenshot of a "New Contact" dialog box. The title bar says "New Contact" and "(Local)". Below the title bar is a tab labeled "Identity" with a right-pointing arrow. The form contains several fields: "First name", "Last Name", "Ring Tone" (with "Standard Ring Tone" selected), "Job Title", and "Organization". At the bottom, there are "Save" and "Cancel" buttons.

4. (Optional) Navigate to the **Ring Tone** field and press the left and right keys to select the desired ring tone for the respective contact.
5. Press the  key to navigate to the **Identity** tab, and press the  key to switch to the **Numbers** tab.

- Under the **Numbers** tab, use the ▲ and ▼ keys to navigate to the respective phone number fields (e.g. Work 1, Work 2, Mobile, etc...) and using the dialpad keys input the contact's numbers in the desired fields.



Note: For each number you can assign a specific line (if available) to dial out on by selecting the respective Line field and pressing the left and right keys to switch lines.

- Press the ▼ key to navigate to the **Numbers** tab, and press the ► key to switch to the **Work Address** tab.
- Under the **Work Address** tab, use the ▲ and ▼ keys to navigate to the desired fields and using the dialpad keys input the work address information of the respective contact.

- Press the ▼ key to navigate to the **Work Address** tab, and press the ► key to switch to the **Home Address** tab.
- Under the **Home Address** tab, use the ▲ and ▼ keys to navigate to the desired fields and using the dialpad keys input the home address information of the respective contact.

11. Press the **▼** key to navigate to the **Home Address** tab, and press the **▶** key to switch to the **Email** tab.
12. Under the **Email** tab, use the **▲** and **▼** keys to navigate to the desired fields and using the dialpad keys input the email address(es) of the respective contact.

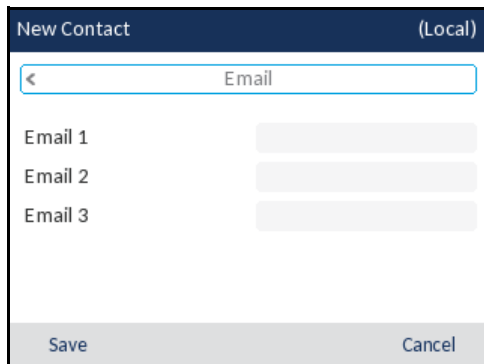

13. Press the **Save** softkey to save your changes.

Editing an Existing Local Directory Entry

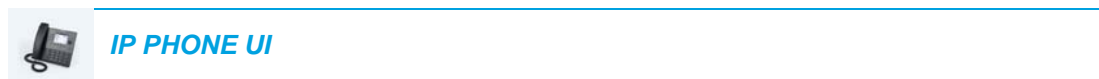

1. Press the **☰** softkey.
2. (Optional) Using the dialpad keys input the first letters of the contact's name to initialize the search function.
3. Use the navigation keys to highlight the contact you want to edit.

No External Sources

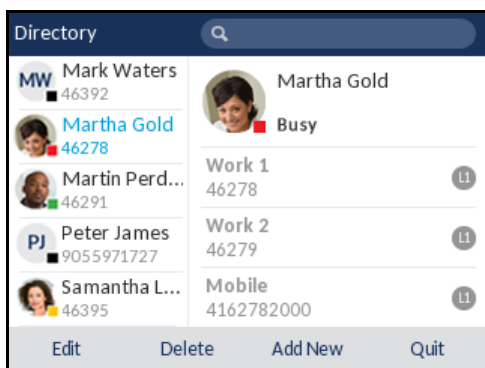

External Sources

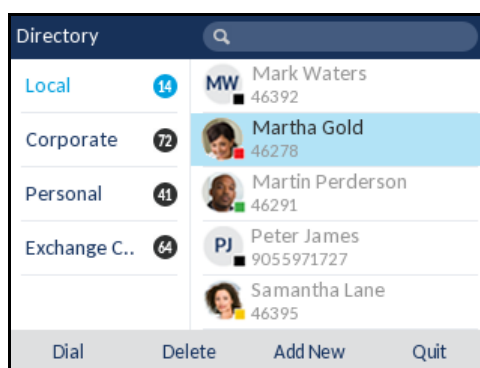

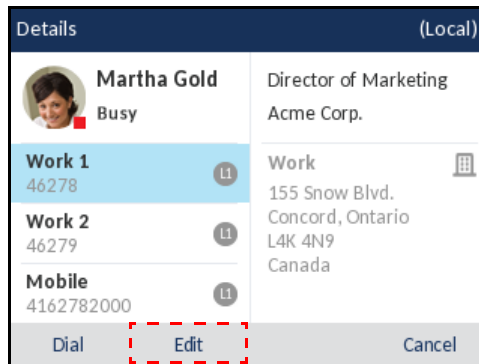

4. Press the **Edit** softkey (if no external Directory sources are configured/enabled) or navigate to the contact's **Details** page and press the **Edit** softkey.

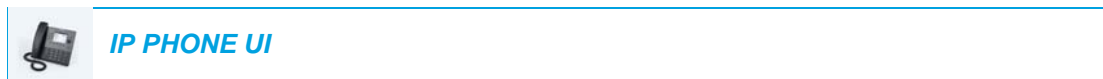

5. Use the navigation keys to navigate through the various tabs and fields and edit any desired information using the dialpad keys.
6. Press the **Save** softkey to save your changes.

Deleting Entries from the Local Directory (No External Directory Sources Configured/Enabled)



1. Press the  softkey.
2. (Optional) If you want to delete an individual entry, using the dialpad keys input the first letters of the contact's name to initialize the search function.
3. Highlight the desired entry (if applicable) and press the **Delete** softkey.

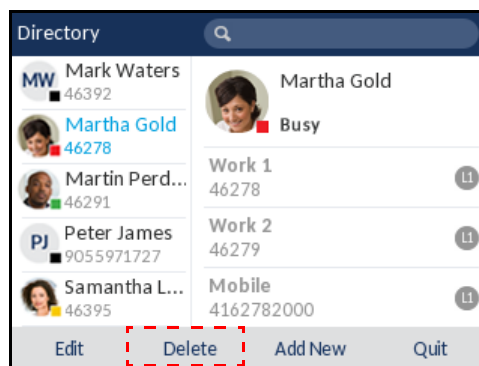

A "Delete selected item or delete all items?" message will appear on screen.

4. Press the **Delete All** softkey to delete all contacts from your Local Directory.
or
Press the **Delete Item** softkey to delete the individual entry from your Local Directory.



Note: Press the **Cancel** softkey to cancel the delete process.

Deleting All Entries from the Local Directory (External Directory Sources Configured/Enabled)



1. Press the  softkey.
2. Press the **Delete** softkey.

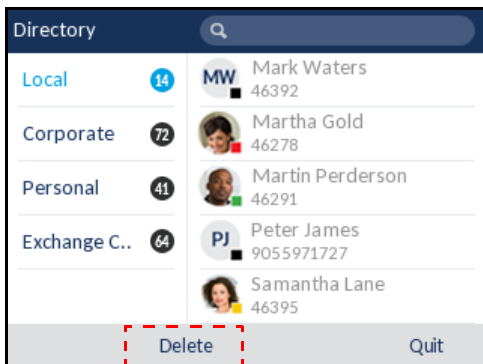

A "Delete all entries in Local" message will appear on screen.



3. Press the **Delete** softkey again to delete all contacts from your Local Directory.



Note: Press the **Cancel** softkey to cancel the delete process.

Deleting Individual Entries from the Directory (External Directory Sources Configured/Enabled)



1. Press the  softkey.
2. (Optional) Using the dialpad keys input the first letters of the contact's name to initialize the search function.
3. Navigate to the Local Directory contact column and use the  and  keys to highlight the contact you want to delete.

4. Press the **Delete** softkey.

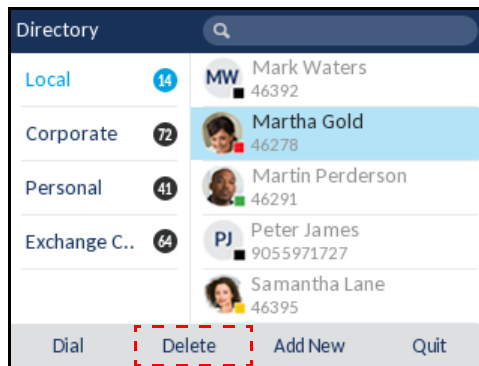

A “Delete <Name> from Local” message will appear on screen.

5. Press the **Delete** softkey again to delete the contact from your Local Directory.



Note: Press the **Cancel** softkey to cancel the delete process.

Downloading the Local Directory to Your PC

You can download the Local Directory to your PC via the Mitel Web UI. The phone stores the *directorylist.csv* file to your PC in comma-separated value (CSV) format.

You can use any spreadsheet application to open the file for viewing. The file displays the following items for each Local Directory entry:

- First Name
- Last Name
- Company
- Job Title
- Work Address Street
- Work Address City
- Work Address State/Province
- Work Address Zip/Postal Code
- Work Address Country
- Home Address Street
- Home Address City
- Home Address State/Province
- Home Address Zip/Postal Code
- Home Address Country
- Email1
- Email2

- Email3
- Number of Total Phone Numbers
- Phone Number 1 Type
- Phone Number 1 Line #
- Phone Number 1
- ...
- Phone Number 7 Type
- Phone Number 7 Line #
- Phone Number 7



1. Click on **Operation > Directory**.

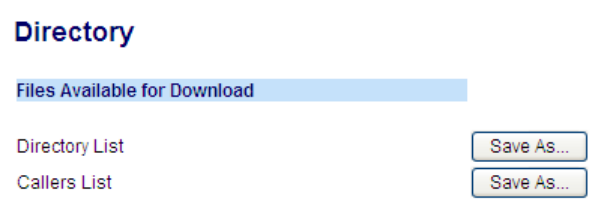

2. In the Directory field, click on **Save As...**
A download window displays.
3. Click **OK**.
4. Enter the location on your computer where you want to download the Directory and click **Save**.
The *directorylist.csv* file downloads to your computer.
5. Use a spreadsheet application to open and view the *directorylist.csv* file.

EXTERNAL DIRECTORY SOURCE FEATURES

The following external Directory sources may be configured on your phone:

- Two CSV-based directories.
- Lightweight Directory Access Protocol (LDAP) Directory.
- Microsoft Exchange contacts (Exchange 2007 SP1 or greater interface supported).
- BroadSoft Xsi Enterprise Directory, Personal Contacts, Enterprise Common Phone List, Group Directory, and Group Common Phone List.

When any of these external Directory sources are configured, the contacts from the respective sources will be loaded into your Directory. From the Directory List, you will be able to search for any external Directory source contacts, dial out to the contacts, copy the contacts to the Local Directory, or simply view the external Directory source contact's details (e.g. title, company name, numbers, work and home addresses, e-mail addresses, etc...).

Configuring an External Directory Source Using the Phone UI

For details on how to enable/disable the external Directory source, change the default folder labels, and enter credentials, please refer to [Enabling/Disabling Directories and Renaming Labels Using the IP Phone UI](#) on page lv and [Entering Usernames/Passwords and Connection Testing Using the IP Phone UI](#) on page lvi.

Copying a Contact in an External Directory Source to the Local Directory

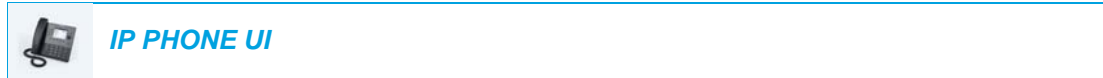

Use the following procedure on the phone's UI to copy an external Directory source contact to the Local Directory.

1. Press the softkey.
2. (Optional) Using the dialpad keys input the first letters of the contact's name to initialize the search function.
3. Navigate to the respective external Directory source's contact column and use the and keys to highlight the contact you want to edit.
4. Press the key to view the contact's **Details** page and press the **Copy** key.

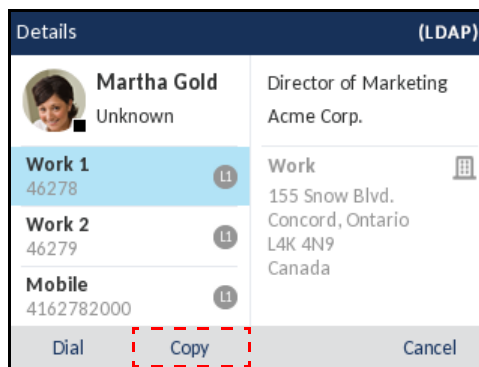

An "Entry copied to Local" message will be displayed indicating the contact was saved to the Local Directory successfully.

RECEIVED CALLERS LIST



Note: Received Callers List information in this User Guide describes the phone’s native Received Callers List. In some environments, the Received Callers List key may bring up a Received Callers List provided by the call manager; therefore, depending on your call manager, the Received Callers List on your phone may function and behave differently than what is documented in this User Guide. If this is the case, contact your System Administrator for more information regarding your specific Received Callers List.



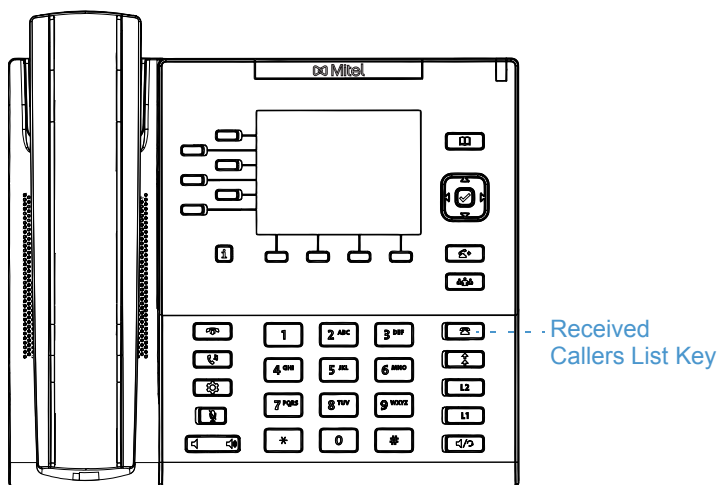

The Received Callers List is a stored log of your incoming calls. The 6867i telephone stores information on up to 200 incoming calls in the Received Callers List. Your telephone logs the name/number of the caller, when they last called, and if the call was answered or missed. Additional information such as the duration of the call, line used, and call features utilized during the call can also be viewed.

You can view, scroll, and delete line items in the Received Callers List from the IP phone UI as well as copy selected entries to the Local Directory. You can also dial out directly using a displayed entry in the Received Callers List.

On the 6867i, you access the Received Callers List by the  key.



The following table identifies and describes the various icons displayed in the Received Callers List.

ICON	DESCRIPTION
	Indicates an incoming call.
	Indicates an incoming call that was not answered.
CALL FEATURE INDICATORS (IN DETAILED VIEW ONLY)	
	Indicates the call was secured using TLS/SRTP encryption.
	Indicates the call was using Mitel Hi-Q™ audio.

ICON DESCRIPTION



Indicates active VoIP recording was enabled and the call was recorded.



Notes:

1. When the Received Callers List is full, the oldest call records are deleted to accommodate the information of new callers.
2. If the telephone number of an incoming or outgoing call matches a number that you have programmed with a name in a softkey or the Directory, the Received Callers List display the same name and number.
3. For details on the total number of Received Callers List entries currently stored on your phone, see [“Phone Status via IP Phone UI”](#) on page xxxii.





ACCESSING AND USING THE RECEIVED CALLERS LIST

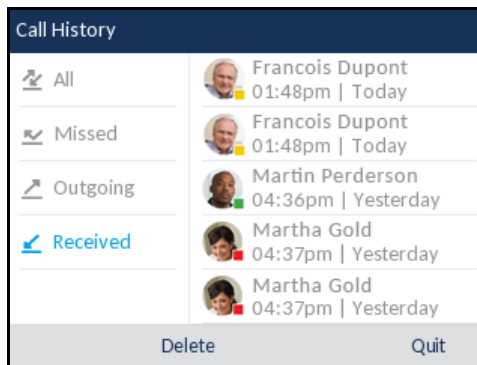

IP PHONE UI





1. Press the  key.

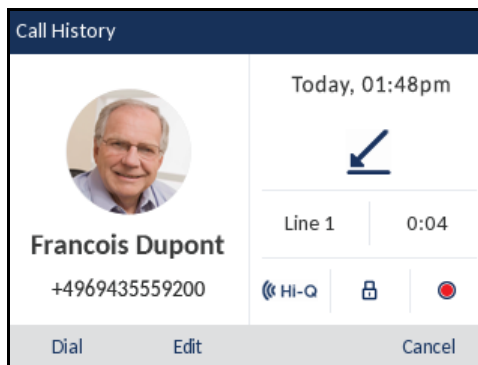

2. With **Received** highlighted press the  key to move to entry column.
3. Use the  and  keys to scroll through the entries in the Received Callers List.
4. Press  key to see more detailed information about the Received Callers List entry.







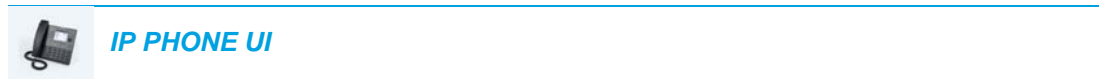

Note: The detailed view screen contains the picture ID of the caller (if available), the date and time of the incoming call, the line on which the call was received, call duration (if the call was answered), any applicable call feature indicators, and the caller ID details.

5. To dial the displayed number while in the Received Callers List, press the  button, press , lift the handset, or press any of the line keys.
6. To exit the Received Callers List, press the  key,  key, or the **Quit** softkey.





EDITING ENTRIES IN THE RECEIVED CALLERS LIST

In the Received Callers List, pressing the **Edit** softkey allows you to edit the entry's name and/or number prior to dialing out or copying to the Local Directory.

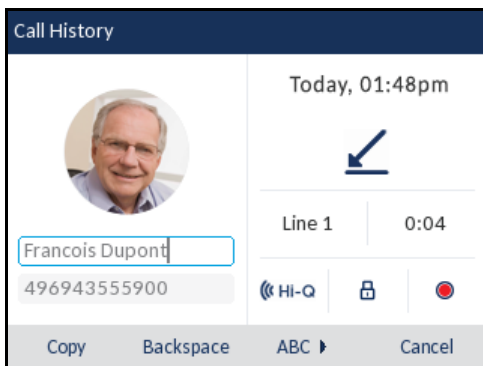

1. Press the  key.
2. With **Received** highlighted press the  key to move to entry column.
3. Use the  and  keys to scroll through the entries in the Received Callers List.
4. Press  key to see more detailed information about the Received Callers List entry.
5. Press the **Edit** softkey.



6. Using the dialpad keys, edit the name and/or number.
 **Note:** To move the cursor one digit/character to the right, press the  navigation key. To erase one digit/character to the left of the cursor, press the **Backspace** softkey.
7. To dial the new number, press the  button, press , lift the handset, or press any of the line keys
or
8. To copy the new number to the Local Directory, press the **Copy** softkey.

DELETING ENTRIES FROM THE RECEIVED CALLERS LIST

You can delete individual entries from the Received Callers List or you can simply delete all entries in the Received Callers List.

To delete all entries from the Received Callers List





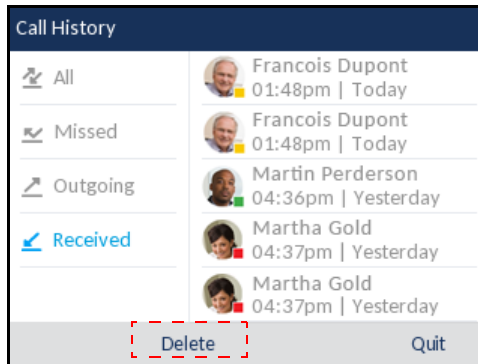

1. Press the  key.
2. Press the **Delete** softkey.

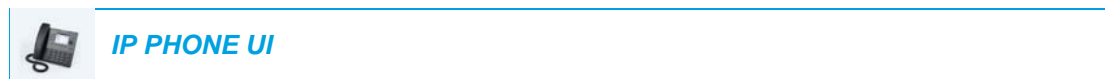

3. Press the **Delete** softkey to erase all items.

To delete an individual entry from the Received Callers List



1. Press the  key.
2. With **Received** highlighted press the  key to move to entry column.
3. Use the  and  keys to scroll through the entries in the Received Callers List.
4. Press the **Delete** softkey.

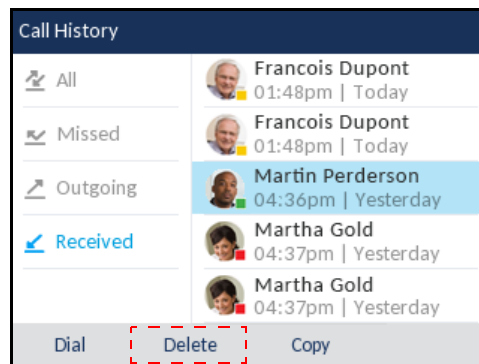

5. Press the **Delete** softkey again to erase the entry.

COPYING ENTRIES TO THE LOCAL DIRECTORY

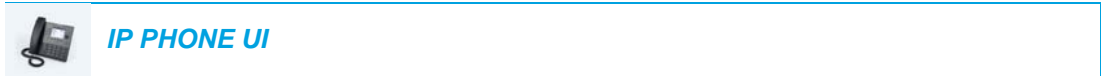

1. Press the key.
2. With **Received** highlighted press the key to move to entry column.
3. Press the and navigation keys to scroll through and highlight the respective Received Callers List entry.

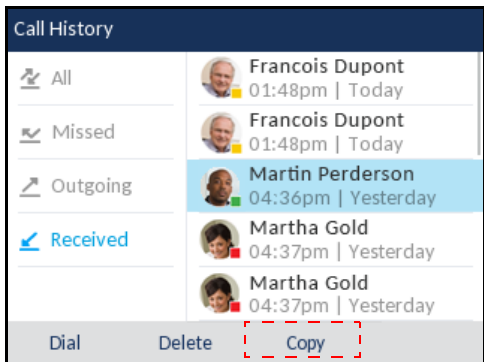

4. Press the **Copy** softkey.
The entry is copied to the Local Directory.



Note: If the contact's name already exists in the Directory but the number is different, press the **Replace** softkey to replace the contact's old number with the new number or press the **Merge** softkey to add the new number as an additional number while keeping the old number intact.

MISSED CALLS INDICATOR

The IP phone has a missed calls indicator and icon that increments the number of missed calls to the phone. The number of calls that have not been answered increment on the phone's Home screen as **# Missed Calls**.

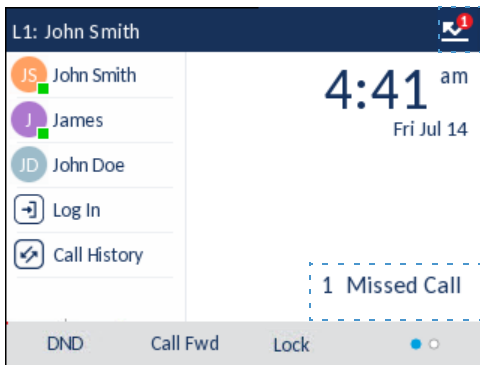





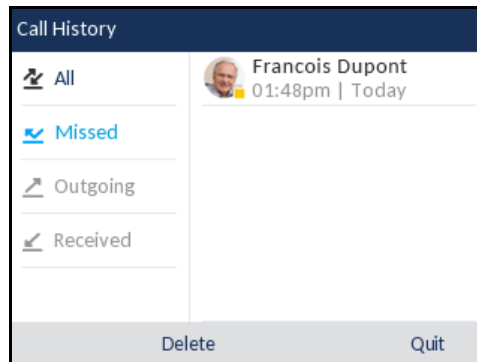

As the number of unanswered calls increment, the phone numbers associated with the calls are stored in the Missed Callers List. When the user accesses the Missed Callers List, the missed calls message on the **Home** screen is cleared.

Viewing Missed Call Details in the Missed Callers List



1. Press the  key.



2. With **Missed** highlighted press the  key to move to entry column.
3. Use the  and  navigation keys to scroll through the entries in the Missed Callers List.
4. Press  key to see more detailed information about the Missed Callers List entry.
5. To exit the Missed Callers List, press the  key,  key or the **Quit** softkey. The missed calls message on the Home screen is cleared upon exit.

DOWNLOADING THE RECEIVED CALLERS LIST TO YOUR PC

You can download the Received Callers List to your PC for viewing using the Mitel Web UI. When you download the Received Callers List, the phone stores the *callerlist.csv* file to your computer in comma-separated value (CSV) format.

You can use any spreadsheet application to open the file for viewing. This file displays the phone number, caller name, and the line that the call came in on.

Downloading the Received Callers List



1. Click on **Operation > Directory**.

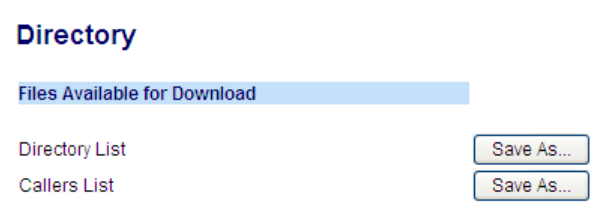

2. In the Callers List field, click on **Save As**.
A download window displays.
3. Click **OK**.
4. Enter the location on your computer where you want to download the Received Callers List and click **Save**.
The *callerlist.csv* file downloads to your computer.
5. Use a spreadsheet application to open and view the Received Callers List.

DND AND CALL FORWARD

The 6867i has a feature that allows you to configure DND and Call Forward for multiple accounts on the phone. You can set specific modes for the way you want the phone to handle DND and Call Forward. The three modes you can set on the phone for these features are:

- Account
- Phone
- Custom

The following paragraphs describe account-based DND and Call Forward:

- DND Configuration
- Call Forward Configuration

DND CONFIGURATION

DND is a feature on the phone that prevents the phone from ringing and receiving incoming calls. When DND is enabled with Call Forward, any incoming calls can be forwarded to your voicemail or another number. See [“Call Forward Configuration”](#) on [page clxxxviii](#) for more information about call forwarding to other numbers.

On the 6867i, you can set DND on the phone-side for a specific account or for all accounts on the phone. You can set three modes for DND using the Mitel Web UI at the path, *Basic Settings > Preferences > General > DND Key Mode: Account, Phone* (default), and *Custom*. DND performs according to the mode you set.

You can then configure a DND key (for the phone or for an expansion module) using the Mitel Web UI at the path, *Operation > Softkeys and XML* or *Operation > Expansion Module <N>*. You can toggle DND on and off by pressing the key, or by setting DND for a specific account at the path, *Basic Settings > Account Configuration*. Once you enable DND, the  icon displays on screen for the applicable account.



Note: If there is only one account configured on the phone, then the mode setting is ignored and the phone behaves as if the mode was set to Phone.

The following describes the key behavior for each DND mode.

- Account: The DND key toggles the account in focus on the IP phone UI to on or off.

- Phone (default): The DND key toggles all accounts on the phone to on or off.
- Custom: The DND key displays custom screens on the IP phone UI. The user can select whether to enable/disable DND per account, enable DND on all accounts, or disable DND on all accounts.

The following table describes the key and Message Waiting Indicator (MWI) LEDs when you enable DND on the IP phone.

**KEY LED BEHAVIOR FOR ALL MODES
(LEFT SOFTKEYS ONLY)**

MWI LED BEHAVIOR FOR ALL MODES

DND key LED RED if current account in focus has DND on.

MWI LED on if current account in focus has DND on.

DND key LED off when current account in focus has DND disabled.

MWI LED off if current account in focus has DND off.



Note: If you make changes to the configuration for DND via the IP phone UI, you must refresh the Mitel Web UI screen to see the changes.

Configuring a DND Key

The following describes the process of configuring DND on your phone. To configure a DND key, see [“Do Not Disturb \(DND\) Key”](#) on [page xcii](#).



Note: If there is no DND key configured or if it has been removed, DND is disabled on the IP phone.

Configuring DND Using the Mitel Web UI



1. Click on **Basic Settings > Preferences > General**.

Preferences

General

Park Call:	<input type="text"/>
Pick Up Parked Call:	<input type="text"/>
Display DTMF Digits	<input checked="" type="checkbox"/> Enabled
Play Call Waiting Tone	<input checked="" type="checkbox"/> Enabled
Stuttered Dial Tone	<input checked="" type="checkbox"/> Enabled
XML Beep Support	<input checked="" type="checkbox"/> Enabled
Status Scroll Delay (seconds)	<input type="text" value="5"/>
Switch UI Focus To Ringing Line	<input checked="" type="checkbox"/> Enabled
Call Hold Reminder During Active Calls	<input checked="" type="checkbox"/> Enabled
Call Hold Reminder	<input checked="" type="checkbox"/> Enabled
Call Waiting Tone Period	<input type="text" value="0"/>
Preferred line	<input type="text" value="None"/>
Preferred line Timeout (seconds)	<input type="text" value="0"/>
Goodbye Key Cancels Incoming Call	<input type="checkbox"/> Enabled
Message Waiting Indicator Line	<input type="text" value="All"/>
DND Key Mode	<input type="text" value="Custom"/>
Call Forward Key Mode	<input type="text" value="Custom"/>

2. In the **DND Key Mode** field, select a DND mode to use on the phone.
 - Account: Sets DND for a specific account. DND key toggles the account in focus on the phone to on or off.
 - Phone (default): Sets DND on for all accounts on the phone. DND key toggles all accounts on the phone to on or off.
 - Custom: Sets the phone to display custom screens after pressing the DND key that list the account(s) on the phone.

The user can select a specific account for DND, turn DND on for all accounts, or turn DND off for all accounts.



Notes:

1. If there is only one account configured on the phone, then the mode setting is ignored and the phone behaves as if the mode was set to Phone.
2. Using the Mitel Web UI, if you change the **DND Key Mode** to Phone, all accounts synchronize to the current setting of Account 1.

3. Click **Save Settings**.
The changes takes affect immediately without a reboot.

4. Click on **Basic Settings > Account Configuration**.

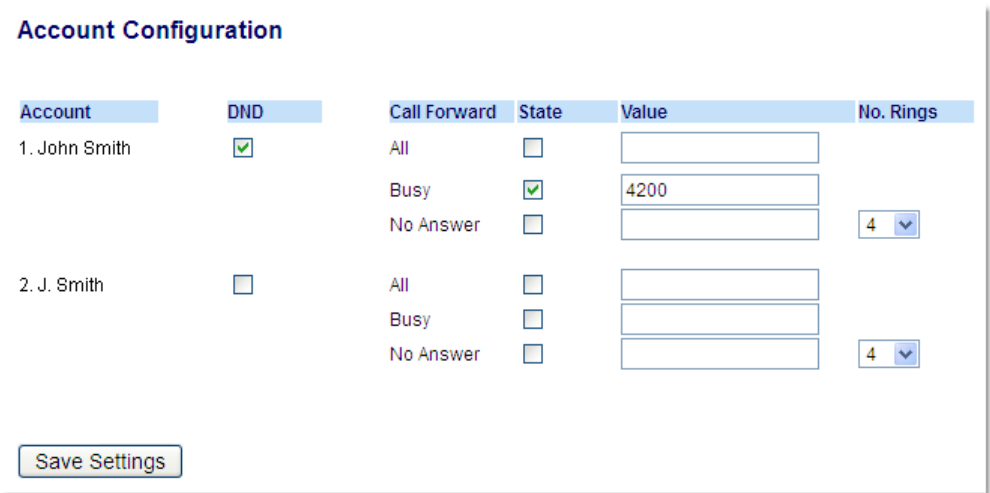

5. For each account, enable DND by placing a check mark in the box. Disable DND by unchecking the box.



Notes:

1. If you selected Account or Custom mode in Step 2, you can enable/disable each account or all accounts as applicable. If you selected Phone mode, the first account allows you to change the DND status for all accounts.
2. Number and name of accounts that display to this screen are dependent on the number and name of accounts configured on the phone. Only your Administrator can create accounts for your phone. Contact your Administrator for more information.

6. Click **Save Settings**.
The changes takes affect immediately without a reboot.

CONFIGURING DND MODES USING THE IP PHONE UI

After you add a DND key to your phone, you can toggle the DND state using this key on the phone. Use the following procedure to enable/disable DND on the IP phone.

The following procedures assume you have already configured a DND key AND assumes there are multiple accounts configured on the phone.

DND in Account Mode



1. From the **Home** screen press the **▶** navigation key to move to the **Line Selection** screen.
2. Highlight the desired account using the **▲ and ▼** navigation keys.
3. Press the **◀** navigation key to go back to the **Home** screen
4. With the account in focus on the **Home** screen, press the **DND** softkey to toggle DND on or off for the account.

DND in Phone Mode (Default)



IP PHONE UI

1. From the **Home** screen, press the **DND** softkey to toggle DND on or off for all accounts on the phone.



Note: Enabling DND in Phone mode toggles all accounts on the phone to DND on.

DND in Custom Mode



IP PHONE UI

1. From the **Home** screen, press the **DND** softkey.
The screen displays a list of the accounts on the phone and allows you to enable/disable a specific account or all accounts.

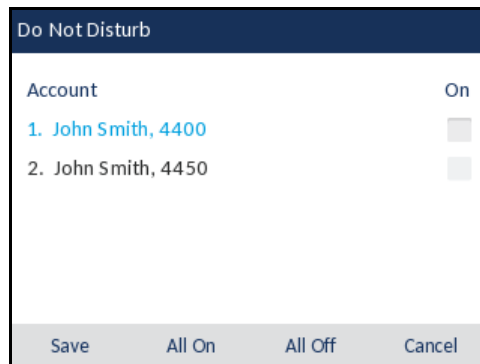

2. Use the ▲ and ▼ navigation keys to scroll through the accounts and press the button to enable DND for the selected account.



Note: Press the **All On** or **All Off** softkeys to quickly enable or disable DND for all accounts.

3. Press the **Save** softkey to save your changes.

CALL FORWARD CONFIGURATION

Call Forward on the IP phone allows incoming calls to be forwarded to another destination.

On the 6867i, you can set Call Forward on the phone-side for a specific account or for all accounts on the phone. You can set a Call Forward mode using the Mitel Web UI at the path, *Basic Settings > Preferences > General > Call Forward Key Mode: Account* (default), *Phone*, and *Custom*. Call Forward behaves according to the mode you set.

You can configure Call Forward using the Mitel Web UI at the path, *Basic Settings > Account Configuration*, or you can configure Call Forward using the IP phone UI at the path, *Options > Call Forward*.

Using the Mitel Web UI at the path, *Operation > Softkeys and XML*, you can also configure a **Call Forward** key for the phone (or for an expansion module) to use as a shortcut for accessing the Call Forward menu on the phone.

The following describes the behavior for each Call Forward mode.

- **Account** (default): The Account mode allows you to configure Call Forward on a per account basis. Pressing a configured **Call Forward** key applies to the account in focus.
- **Phone**: The Phone mode allows you to set the same Call Forward configuration for all accounts (All, Busy, and/or No Answer). When you configure the initial account, the phone applies the configuration to all other accounts. (In the Mitel Web UI, only the account you configured is enabled. All other accounts are greyed out but set to the same configuration.) Using the Mitel Web UI, if you make changes to that initial account, the changes apply to all accounts on the phone.
- **Custom**: The Custom mode allows you to configure Call Forward for a specific account or all accounts. You can configure a specific mode (All, Busy, and/or No Answer) for each account independently or all accounts. On the 6867i, you can set all accounts to **All On**, **All Off**, or copy the configuration for the account in focus to all other accounts using a **CopytoAll** softkey.



Note: If there is only one account configured on the phone, then the mode setting is ignored and the phone behaves as if the mode was set to Phone.

You can enable different Call Forward rules/modes independently (for example, you can set different phone numbers for Busy, All, and NoAnswer modes and then turn them on/off individually).

The following table describes the key and Message Waiting Indicator (MWI) LEDs when you enable Call Forward on the IP phone.

KEY LED BEHAVIOR FOR ALL MODES (LEFT SOFTKEYS ONLY)

Call Forward key LED RED if any Call Forward mode is enabled for the account in focus.

Call Forward key LED off if all Call Forward modes are disabled for the account in focus.

MWI LED BEHAVIOR FOR ALL MODES

MWI LED on if any Call Forward mode is enabled for the account in focus.

MWI LED off if all Call Forward modes are disabled for the account in focus.



Note: If you make changes to the configuration for Call Forward via the IP phone UI, you must refresh the Mitel Web UI screen to see the changes.

CONFIGURING A CALL FORWARD KEY

The following describes the process of configuring Call Forward on your phone. To configure a Call Forward key, see “[Call Forward Key](#)” on [page cx](#).

CONFIGURING CALL FORWARD USING THE MITEL WEB UI



MITEL WEB UI

1. Click on **Basic Settings > Preferences > General**.

The screenshot shows the 'Preferences' page with the 'General' tab selected. The settings are as follows:

Setting	Value
Park Call:	[Empty text box]
Pick Up Parked Call:	[Empty text box]
Display DTMF Digits	<input checked="" type="checkbox"/> Enabled
Play Call Waiting Tone	<input checked="" type="checkbox"/> Enabled
Stuttered Dial Tone	<input checked="" type="checkbox"/> Enabled
XML Beep Support	<input checked="" type="checkbox"/> Enabled
Status Scroll Delay (seconds)	5
Switch UI Focus To Ringing Line	<input checked="" type="checkbox"/> Enabled
Call Hold Reminder During Active Calls	<input checked="" type="checkbox"/> Enabled
Call Hold Reminder	<input checked="" type="checkbox"/> Enabled
Call Waiting Tone Period	0
Preferred line	None
Preferred line Timeout (seconds)	0
Goodbye Key Cancels Incoming Call	<input type="checkbox"/> Enabled
Message Waiting Indicator Line	All
DND Key Mode	Custom
Call Forward Key Mode	Custom

2. In the **Call Forward Key Mode** field, select a call forward mode to use on the phone.
 - **Account (default):** The Account mode allows you to configure Call Forward on a per account basis. Pressing a configured **Call Forward** key applies to the account in focus.
 - **Phone:** The Phone mode allows you to set the same Call Forward configuration for all accounts (All, Busy, and/or No Answer). When you configure the initial account, the phone applies the configuration to all other accounts. (In the Mitel Web UI, only the account you configured is enabled. All other accounts are greyed out but set to the same configuration.) Using the Mitel Web UI, if you make changes to that initial account, the changes apply to all accounts on the phone.
 - **Custom:** The Custom mode allows you to configure Call Forward for a specific account or all accounts. You can configure a specific state (All, Busy, and/or No Answer) for each account independently or all accounts. On the 6867i, you can set all accounts to

All On, All Off, or copy the configuration for the account in focus to all other accounts using a **CopytoAll** softkey.



Note: If there is only one account configured on the phone, then the mode setting is ignored and the phone behaves as if the mode was set to Phone.

3. Click **Save Settings**.
The changes takes affect immediately without a reboot.
4. Click on **Basic Settings > Account Configuration**.

Account Configuration

Account	DND	Call Forward	State	Value	No. Rings
1. John Smith	<input checked="" type="checkbox"/>	All	<input type="checkbox"/>	<input type="text"/>	4 ▾
		Busy	<input checked="" type="checkbox"/>	4200	
		No Answer	<input type="checkbox"/>	<input type="text"/>	
2. J. Smith	<input type="checkbox"/>	All	<input type="checkbox"/>	<input type="text"/>	4 ▾
		Busy	<input type="checkbox"/>	<input type="text"/>	
		No Answer	<input type="checkbox"/>	<input type="text"/>	

The illustration above shows 2 accounts configured on the phone. Accounts must be set up by your System Administrator.



Note: If the BroadSoft BroadWorks Executive and Assistant Services feature is enabled and your phone is configured with the Assistant’s role, an additional Forward Filtering option may be available on the Account Configuration page. For information on the BroadWorks Executive and Assistant Services feature, refer to [BroadSoft BroadWorks Executive and Assistant Services](#) on page ccxv.

5. For each account, enable the Call Forward state by placing a check mark in one or more of the following **State** fields:
 - All
 - Busy
 - No Answer

The All option forwards all incoming calls for this account to the specified phone number regardless of the state of the phone. The phone can be in the Busy or No Answer states, or can be in the idle state. The phone still forwards all calls to the specified number.

The Busy option call forwards incoming calls only if the account is in the busy state. The calls are forwarded to the specified phone number.

The No Answer option call forwards incoming calls only if the account rings but is not answered in the defined number of rings. The call gets forwarded to the specified number.



Note: You can use the Busy and No Answer states together using different forwarding phone numbers. If these states are enabled for an account (the All state is disabled), and the phone is in the busy state when a call comes in, the phone can forward the call to the specified phone number (for example, voicemail). If there is no answer on the phone after the specified number of rings, the phone can forward the call to a different specified number, such as a cell phone number.

6. For each account, in the **Value** field, enter the phone number for which you want the incoming calls to forward to if the phone is in the specified state.
If using the Account mode or Custom mode, you can enter different phone numbers for each account.



Notes:

1. If you selected Account mode in Step 5, you can enable/disable each account or all accounts as applicable. You can enter different phone number for each enabled state.
 2. If you selected Custom mode, you can enable/disable each account or all accounts as applicable. You can enter different phone numbers for each enabled state.
 3. If you selected Phone mode, all accounts are set to the same Call Forward configuration (All, Busy, and/or No Answer) as Account 1 on the phone. In the Mitel Web UI, only Account 1 is enabled. All other accounts are greyed out but use the same configuration as Account 1.
 4. Using the Mitel Web UI, if you make changes to Account 1, the changes apply to all accounts on the phone. Using the IP phone UI, if you make changes to any other account other than Account 1, the changes also apply to all accounts on the phone. When enabling a Call Forward state, you must specify a phone number for the phone to Call Forward to. The number you specify applies to all accounts of the same mode.
 5. Number and name of accounts that display to this screen are dependent on the number and name of accounts configured on the phone. The name for the account is specified by your System Administrator. Contact your System Administrator for more information.
7. For the No Answer state, in the **No. Rings** field, enter the number of times that the account rings before forwarding the call to the specified number. Valid values are 1 through 20. Default is 1.
 8. When using the Account mode or Custom mode, you can enter a different number of rings for each account. If you use the Mitel Web UI to change the Call Forward Key Mode to Phone, all accounts synchronize to Account 1.
 9. Click **Save Settings**.
The changes takes affect immediately without a reboot.

USING CALL FORWARD VIA THE IP PHONE UI

Once Call Forward is enabled on your phone, you can access the Call Forward menus by pressing a pre-configured **Call Forward** key, or by selecting *Options > Call Forward* from the IP phone UI.



Note: If the BroadSoft BroadWorks Executive and Assistant Services feature is enabled and your phone is configured with the Assistant's role, an additional Forward Filtering option may be available on the Account Configuration page. For information on the BroadWorks Executive and Assistant Services feature, refer to [BroadSoft BroadWorks Executive and Assistant Services](#) on page cxcv.

Call Forward in Account Mode

IP PHONE UI

1. From the **Home** screen press the navigation key to move to the **Line Selection** screen.
2. Highlight the desired account using the and navigation keys.
3. Press the navigation key to go back to the **Home** screen
4. With the account in focus on **Home** screen, press the configured **Call Fwd** softkey or press , navigate to the **Call Forward** option and press the button or **Select** softkey. The Call Forward screen displays for the account you selected.

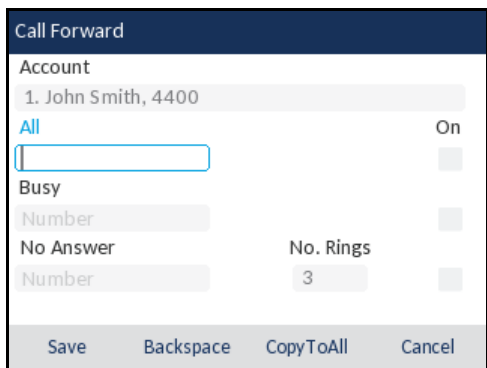

5. Enter forwarding numbers using the dialpad keys for any of the following states:
 - All: Forwards all incoming calls for the respective account to the specified number.
 - Busy: Forwards incoming calls to a specified number if DND has been enabled for that account OR if the account is currently engaged in another call.

- No Answer: Forwards incoming calls to a specified number if the call has not been answered for the specified number of rings.



Notes:

1. Pressing the ▲ navigation key moves the selection to the next field/checkbox.
 2. If All and Busy and No Answer are all enabled (and/or if the account has DND enabled), the All settings take precedence over Busy and No Answer.
 3. Pressing the **CopyToAll** key copies the call forward number of the Call Forward mode in focus to every Call Forward mode of that account. For example, if you have the cursor pointing at the All state and has a call forward phone number configured, pressing the **CopytoAll** key assigns the same phone number to the Busy and No Answer states as well.
6. If configuring a forwarding number for the No Answer state, navigate to the **No. Rings** field and press the ◀ and ▶ navigation keys to change the desired number of rings.
 7. Using the ▲ navigation key, move to the **On** checkbox beside the respective Call Forward mode and press the button to enable the Call Forward mode.
 8. Press the **Save** softkey to save your changes.

Call Forward in Phone Mode



IP PHONE UI

1. Press the configured **Call Fwd** softkey or press with a gear icon, navigate to the **Call Forward** option and press the button or **Select** softkey. The Call Forward screen displays and is applicable to all accounts configured on the phone.

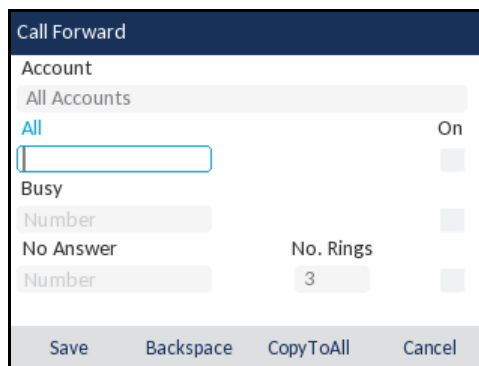

2. Enter forwarding numbers using the dialpad keys for any of the following states:
 - All: Forwards all incoming calls for the respective account to the specified number.
 - Busy: Forwards incoming calls to a specified number if DND has been enabled for that account OR if the account is currently engaged in another call.

- No Answer: Forwards incoming calls to a specified number if the call has not been answered for the specified number of rings.



Notes:

1. Pressing the ▲ navigation key moves the selection to the next field/checkbox.
2. If All and Busy and No Answer are all enabled (and/or if the account has DND enabled), the All settings take precedence over Busy and No Answer.
3. Pressing the **CopyToAll** key copies the call forward number of the Call Forward mode in focus to every Call Forward mode of that account. For example, if you have the cursor pointing at the All state and has a call forward phone number configured, pressing the **CopytoAll** key assigns the same phone number to the Busy and No Answer states as well.

3. If configuring a forwarding number for the No Answer state, navigate to the **No. Rings** field and press the ◀ and ▶ navigation keys to change the desired number of rings.
4. Using the ▲ navigation key, move to the **On** checkbox beside the respective Call Forward mode and press the button to enable the Call Forward mode.
5. Press the **Save** softkey to save your changes.



Note: In **Phone** mode, the configuration applies to all the accounts on the phone.

Call Forward in Custom Mode

IP PHONE UI

1. Press the configured **Call Fwd** softkey or press with a gear icon, navigate to the **Call Forward** option and press the button or **Select** softkey. The Call Forward screen displays.

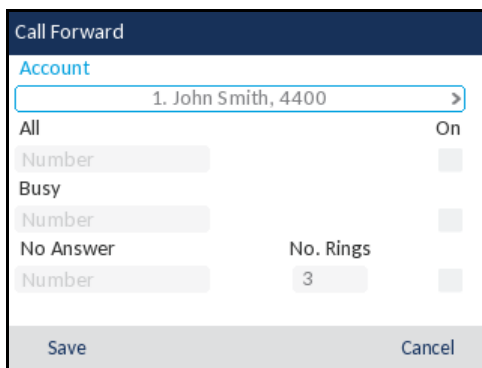

2. Press the ◀ and ▶ navigation keys to change to the desired account.



Note: Select **All Accounts** if you want your changes to be made to all the accounts configured on the phone

3. Enter forwarding numbers using the dialpad keys for any of the following states:
 - All: Forwards all incoming calls for the respective account to the specified number.

- **Busy:** Forwards incoming calls to a specified number if DND has been enabled for that account OR if the account is currently engaged in another call.
- **No Answer:** Forwards incoming calls to a specified number if the call has not been answered for the specified number of rings.



Notes:

1. Pressing the ▲ navigation key moves the selection to the next field/checkbox.
 2. If All and Busy and No Answer are all enabled (and/or if the account has DND enabled), the All settings take precedence over Busy and No Answer.
 3. Pressing the **CopyToAll** key copies the call forward number of the Call Forward mode in focus to every Call Forward mode of that account. For example, if you have the cursor pointing at the All state and has a call forward phone number configured, pressing the **CopytoAll** key assigns the same phone number to the Busy and No Answer states as well.
4. If configuring a forwarding number for the No Answer state, navigate to the **No. Rings** field and press the ◀ and ▶ navigation keys to change the desired number of rings.
 5. Using the ▲ navigation key, move to the **On** checkbox beside the respective Call Forward mode and press the button to enable the Call Forward mode.
 6. Press the **Save** softkey to save your changes.

ADDITIONAL FEATURES

This section describes additional features you can use on the 6867i phone.

DISPLAY DTMF DIGITS

A feature on the 6867i phone allows users to enable or disable DTMF (dual-tone multi-frequency) digits to display to the IP phone when using the dialpad to dial, or when dialing from a softkey or expansion module key.

DTMF is the signal sent from the phone to the network that you generate when you press the phone's touch keys. This is also known as touchtone dialing. Each key you press on your phone generates two tones of specific frequencies. One tone is generated from a high-frequency group of tones and the other from a low frequency group.

If you enable the **Display DTMF Digits** parameter, the digits you are dialing from the dialpad or softkey display to the IP phone's LCD display. This parameter is disabled by default (no digits display when dialing).

You can enable the **Display DTMF Digits** parameter using the Mitel Web UI.

CONFIGURING DISPLAY OF DTMF DIGITS



1. Click on **Basic Settings > Preferences > General**.

Preferences	
General	
Park Call:	<input type="text"/>
Pick Up Parked Call:	<input type="text"/>
Display DTMF Digits	<input checked="" type="checkbox"/> Enabled
Play Call Waiting Tone	<input checked="" type="checkbox"/> Enabled
Stuttered Dial Tone	<input checked="" type="checkbox"/> Enabled
XML Beep Support	<input checked="" type="checkbox"/> Enabled
Status Scroll Delay (seconds)	<input type="text" value="5"/>
Switch UI Focus To Ringing Line	<input checked="" type="checkbox"/> Enabled
Call Hold Reminder During Active Calls	<input checked="" type="checkbox"/> Enabled
Call Hold Reminder	<input checked="" type="checkbox"/> Enabled
Call Waiting Tone Period	<input type="text" value="0"/>
Preferred line	None <input type="button" value="v"/>
Preferred line Timeout (seconds)	<input type="text" value="0"/>
Goodbye Key Cancels Incoming Call	<input type="checkbox"/> Enabled
Message Waiting Indicator Line	All <input type="button" value="v"/>
DND Key Mode	Custom <input type="button" value="v"/>
Call Forward Key Mode	Custom <input type="button" value="v"/>

2. Enable the **Display DTMF Digits** field by checking the check box. Disable this field by unchecking the box (default is disabled).
3. Click **Save Settings** to save your settings.

PLAY CALL WAITING TONE

You can enable or disable the playing of a call waiting tone when a caller is on an active call and a new call comes into the phone.

You can configure this feature using the Mitel Web UI.

CONFIGURING CALL WAITING TONE



MITEL WEB UI

1. Click on **Basic Settings > Preferences > General**.

Preferences

General

Park Call:	<input type="text"/>
Pick Up Parked Call:	<input type="text"/>
Display DTMF Digits	<input checked="" type="checkbox"/> Enabled
Play Call Waiting Tone	<input checked="" type="checkbox"/> Enabled
Stuttered Dial Tone	<input checked="" type="checkbox"/> Enabled
XML Beep Support	<input checked="" type="checkbox"/> Enabled
Status Scroll Delay (seconds)	<input type="text" value="5"/>
Switch UI Focus To Ringing Line	<input checked="" type="checkbox"/> Enabled
Call Hold Reminder During Active Calls	<input checked="" type="checkbox"/> Enabled
Call Hold Reminder	<input checked="" type="checkbox"/> Enabled
Call Waiting Tone Period	<input type="text" value="0"/>
Preferred line	<input type="text" value="None"/> ▼
Preferred line Timeout (seconds)	<input type="text" value="0"/>
Goodbye Key Cancels Incoming Call	<input type="checkbox"/> Enabled
Message Waiting Indicator Line	<input type="text" value="All"/> ▼
DND Key Mode	<input type="text" value="Custom"/> ▼
Call Forward Key Mode	<input type="text" value="Custom"/> ▼

2. The **Play Call Waiting Tone** field is enabled by default. To disable this field, uncheck the box.
3. Click **Save Settings** to save your settings.

STUTTERED DIAL TONE

You can enable or disable the playing of a stuttered dial tone when there is a message waiting on the IP phone.

You can configure this feature using the Mitel Web UI.

CONFIGURING STUTTERED DIAL TONE

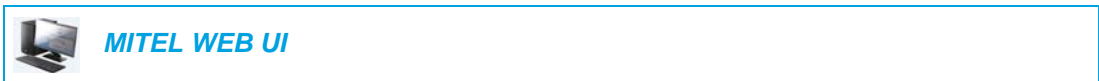

1. Click on **Basic Settings > Preferences > General**.

A screenshot of the Mitel Web UI Preferences page, General tab. The page has a title "Preferences" and a sub-tab "General" which is highlighted. Below the sub-tab is a list of settings with their corresponding input fields or checkboxes. The "Stuttered Dial Tone" setting is checked and enabled.

Preferences	
General	
Park Call:	<input type="text"/>
Pick Up Parked Call:	<input type="text"/>
Display DTMF Digits	<input checked="" type="checkbox"/> Enabled
Play Call Waiting Tone	<input checked="" type="checkbox"/> Enabled
Stuttered Dial Tone	<input checked="" type="checkbox"/> Enabled
XML Beep Support	<input checked="" type="checkbox"/> Enabled
Status Scroll Delay (seconds)	<input type="text" value="5"/>
Switch UI Focus To Ringing Line	<input checked="" type="checkbox"/> Enabled
Call Hold Reminder During Active Calls	<input checked="" type="checkbox"/> Enabled
Call Hold Reminder	<input checked="" type="checkbox"/> Enabled
Call Waiting Tone Period	<input type="text" value="0"/>
Preferred line	<input type="text" value="None"/>
Preferred line Timeout (seconds)	<input type="text" value="0"/>
Goodbye Key Cancels Incoming Call	<input type="checkbox"/> Enabled
Message Waiting Indicator Line	<input type="text" value="All"/>
DND Key Mode	<input type="text" value="Custom"/>
Call Forward Key Mode	<input type="text" value="Custom"/>

2. The **Stuttered Dial Tone** field is enabled by default. To disable this field, uncheck the box.
3. Click **Save Settings** to save your settings.

XML BEEP SUPPORT

Using the Mitel Web UI, you can enable or disable a beep to be audible when the phone receives an XML application using the **XML Beep Support** field at the path *Basic Settings > Preferences > General*. If you disable this feature, then no beep is heard when the XML application arrives to the phone.

If your System Administrator has set a value for this feature in a custom XML application or in the configuration files, the value you set in the Mitel Web UI overrides the Administrator's setting. Setting and saving the value in the Mitel Web UI applies to the phone immediately.

CONFIGURING XML BEEP SUPPORT



MITEL WEB UI

1. Click on **Basic Settings > Preferences > General**.

Preferences

General

Park Call:	<input type="text"/>
Pick Up Parked Call:	<input type="text"/>
Display DTMF Digits	<input checked="" type="checkbox"/> Enabled
Play Call Waiting Tone	<input checked="" type="checkbox"/> Enabled
Stuttered Dial Tone	<input checked="" type="checkbox"/> Enabled
XML Beep Support	<input checked="" type="checkbox"/> Enabled
Status Scroll Delay (seconds)	<input type="text" value="5"/>
Switch UI Focus To Ringing Line	<input checked="" type="checkbox"/> Enabled
Call Hold Reminder During Active Calls	<input checked="" type="checkbox"/> Enabled
Call Hold Reminder	<input checked="" type="checkbox"/> Enabled
Call Waiting Tone Period	<input type="text" value="0"/>
Preferred line	<input type="text" value="None"/> ▼
Preferred line Timeout (seconds)	<input type="text" value="0"/>
Goodbye Key Cancels Incoming Call	<input type="checkbox"/> Enabled
Message Waiting Indicator Line	<input type="text" value="All"/> ▼
DND Key Mode	<input type="text" value="Custom"/> ▼
Call Forward Key Mode	<input type="text" value="Custom"/> ▼

2. The **XML Beep Support** field is enabled by default. To disable this field, uncheck the box.
3. Click **Save Settings**.

STATUS SCROLL DELAY

Using the Mitel Web UI, you can specify a scroll delay option that allows you to set the time delay, in seconds, between the scrolling of each status message on the phone. You can specify this setting in the **Status Scroll Delay (seconds)** field at the path *Basic Settings > Preferences > General*. The default time is 5 seconds for each message to display before scrolling to the next message. You can increase or decrease this time as required. Setting and saving the value in the Mitel Web UI applies to the phone immediately.

CONFIGURING STATUS SCROLL DELAY



1. Click on **Basic Settings > Preferences > General**.

A screenshot of the Mitel Web UI Preferences page, specifically the General tab. The page has a title "Preferences" and a sub-tab "General" which is highlighted. Below the sub-tab, there is a list of settings. The "Status Scroll Delay (seconds)" setting is highlighted in blue. The value for this setting is "5". Other settings include "Park Call:", "Pick Up Parked Call:", "Display DTMF Digits" (checked), "Play Call Waiting Tone" (checked), "Stuttered Dial Tone" (checked), "XML Beep Support" (checked), "Switch UI Focus To Ringing Line" (checked), "Call Hold Reminder During Active Calls" (checked), "Call Hold Reminder" (checked), "Call Waiting Tone Period" (0), "Preferred line" (None), "Preferred line Timeout (seconds)" (0), "Goodbye Key Cancels Incoming Call" (unchecked), "Message Waiting Indicator Line" (All), "DND Key Mode" (Custom), and "Call Forward Key Mode" (Custom).

Preferences	
General	
Park Call:	<input type="text"/>
Pick Up Parked Call:	<input type="text"/>
Display DTMF Digits	<input checked="" type="checkbox"/> Enabled
Play Call Waiting Tone	<input checked="" type="checkbox"/> Enabled
Stuttered Dial Tone	<input checked="" type="checkbox"/> Enabled
XML Beep Support	<input checked="" type="checkbox"/> Enabled
Status Scroll Delay (seconds)	<input type="text" value="5"/>
Switch UI Focus To Ringing Line	<input checked="" type="checkbox"/> Enabled
Call Hold Reminder During Active Calls	<input checked="" type="checkbox"/> Enabled
Call Hold Reminder	<input checked="" type="checkbox"/> Enabled
Call Waiting Tone Period	<input type="text" value="0"/>
Preferred line	<input type="text" value="None"/>
Preferred line Timeout (seconds)	<input type="text" value="0"/>
Goodbye Key Cancels Incoming Call	<input type="checkbox"/> Enabled
Message Waiting Indicator Line	<input type="text" value="All"/>
DND Key Mode	<input type="text" value="Custom"/>
Call Forward Key Mode	<input type="text" value="Custom"/>

2. Enter a value in the **Status Scroll Delay (seconds)** field. Valid values are: 1 to 25 seconds. Default is 5 seconds.
3. Click **Save Settings** to save our changes.

SWITCH UI FOCUS TO RINGING LINE

You can configure a feature on the 6867i that controls the behavior of the phone when it receives an incoming call when it is already in a connected call. When a call comes into the phone, and the phone is already on a connected call, the phone switches focus to the ringing line to enable the user to see who is calling them. You can turn off this functionality so that the phone stays focused on the connected call. You can do this using the **Switch Focus to Ringing Line** parameter in the Mitel Web UI.

CONFIGURING SWITCH FOCUS TO RINGING LINE



MITEL WEB UI

1. Click on **Basic Settings > Preferences > General**.

Preferences

General

Park Call:	<input type="text"/>
Pick Up Parked Call:	<input type="text"/>
Display DTMF Digits	<input checked="" type="checkbox"/> Enabled
Play Call Waiting Tone	<input checked="" type="checkbox"/> Enabled
Stuttered Dial Tone	<input checked="" type="checkbox"/> Enabled
XML Beep Support	<input checked="" type="checkbox"/> Enabled
Status Scroll Delay (seconds)	<input type="text" value="5"/>
Switch UI Focus To Ringing Line	<input checked="" type="checkbox"/> Enabled
Call Hold Reminder During Active Calls	<input checked="" type="checkbox"/> Enabled
Call Hold Reminder	<input checked="" type="checkbox"/> Enabled
Call Waiting Tone Period	<input type="text" value="0"/>
Preferred line	<input type="text" value="None"/> ▼
Preferred line Timeout (seconds)	<input type="text" value="0"/>
Goodbye Key Cancels Incoming Call	<input type="checkbox"/> Enabled
Message Waiting Indicator Line	<input type="text" value="All"/> ▼
DND Key Mode	<input type="text" value="Custom"/> ▼
Call Forward Key Mode	<input type="text" value="Custom"/> ▼

2. The **Switch Focus to Ringing Line** field is enabled by default. To disable this field, uncheck the box.
3. Click **Save Settings** to save your settings.

CALL HOLD REMINDER DURING ACTIVE CALLS

The IP phones allow you to enable or disable the ability for the phone to initiate a continuous reminder tone on the active call when another call is on hold. For example, when this feature is enabled, and the call on Line 1 is on hold, and then the you answer a call on Line 2 and stay on that line, a reminder tone is played in the active audio path on Line 2 to remind you that there is still a call on hold on Line 1.

When this feature is disabled, a ring splash is heard when the active call hangs up and there is still a call on hold.

You can enable or disable this feature using the **Call Hold Reminder During Active Calls** parameter in the Mitel Web UI.

CONFIGURING CALL HOLD REMINDER DURING ACTIVE CALLS

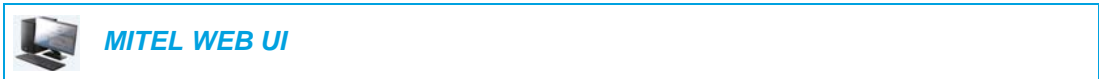

1. Click on **Basic Settings > Preferences > General**.

Preferences	
General	
Park Call:	<input type="text"/>
Pick Up Parked Call:	<input type="text"/>
Display DTMF Digits	<input checked="" type="checkbox"/> Enabled
Play Call Waiting Tone	<input checked="" type="checkbox"/> Enabled
Stuttered Dial Tone	<input checked="" type="checkbox"/> Enabled
XML Beep Support	<input checked="" type="checkbox"/> Enabled
Status Scroll Delay (seconds)	<input type="text" value="5"/>
Switch UI Focus To Ringing Line	<input checked="" type="checkbox"/> Enabled
Call Hold Reminder During Active Calls	<input checked="" type="checkbox"/> Enabled
Call Hold Reminder	<input checked="" type="checkbox"/> Enabled
Call Waiting Tone Period	<input type="text" value="0"/>
Preferred line	<input type="text" value="None"/>
Preferred line Timeout (seconds)	<input type="text" value="0"/>
Goodbye Key Cancels Incoming Call	<input type="checkbox"/> Enabled
Message Waiting Indicator Line	<input type="text" value="All"/>
DND Key Mode	<input type="text" value="Custom"/>
Call Forward Key Mode	<input type="text" value="Custom"/>

2. The **Call Hold Reminder During Active Calls** field is disabled by default. To enabled this field, check the box.
When this feature is enabled, a reminder tone is heard on the active call when another call is on hold. When disabled, a ring splash is heard when the active call hangs up and there is still a call on hold.
3. Click **Save Settings**.

CALL HOLD REMINDER (ON SINGLE HOLD)

On the 6867i IP phone, you can enable or disable a feature that will start the reminder ring splash timer as soon as you put a call on hold (even when no other calls are active on the phone). When enabled, the phone initiates a reminder ring splash periodically for the single call on hold. When disabled, no reminder ring splash is audible.

You can enable or disable this feature using the **Call Hold Reminder** parameter in the Mitel Web UI.

CONFIGURING CALL HOLD REMINDER



MITEL WEB UI

1. Click on **Basic Settings > Preferences > General**

Preferences

General

Park Call:	<input type="text"/>
Pick Up Parked Call:	<input type="text"/>
Display DTMF Digits	<input checked="" type="checkbox"/> Enabled
Play Call Waiting Tone	<input checked="" type="checkbox"/> Enabled
Stuttered Dial Tone	<input checked="" type="checkbox"/> Enabled
XML Beep Support	<input checked="" type="checkbox"/> Enabled
Status Scroll Delay (seconds)	<input type="text" value="5"/>
Switch UI Focus To Ringing Line	<input checked="" type="checkbox"/> Enabled
Call Hold Reminder During Active Calls	<input checked="" type="checkbox"/> Enabled
Call Hold Reminder	<input checked="" type="checkbox"/> Enabled
Call Waiting Tone Period	<input type="text" value="0"/>
Preferred line	<input type="text" value="None"/> ▼
Preferred line Timeout (seconds)	<input type="text" value="0"/>
Goodbye Key Cancels Incoming Call	<input type="checkbox"/> Enabled
Message Waiting Indicator Line	<input type="text" value="All"/> ▼
DND Key Mode	<input type="text" value="Custom"/> ▼
Call Forward Key Mode	<input type="text" value="Custom"/> ▼

2. The **Call Hold Reminder** field is disabled by default. To enabled this field, check the box. When this feature is enabled, the reminder ring splash timer starts as soon as you put a call on hold (even when no other calls are active on the phone). The phone initiates a reminder ring splash periodically for the single call on hold. When disabled, no reminder ring splash is audible.
3. Click **Save Settings**.

CALL WAITING TONE PERIOD

You can specify a specific time period (in seconds) for the call waiting tone to play at regular intervals on an active call using the parameter **Call Waiting Tone Period**. A value of 0 is the default and plays the call waiting tone only once on the active call. When the incoming caller hangs up, the call waiting tone stops on the existing active call.

You can enable or disable this feature in the Mitel Web UI.

CONFIGURING CALL WAITING TONE PERIOD

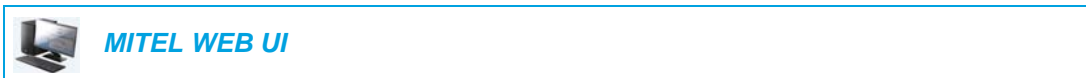

1. Click on **Basic Settings > Preferences > General**

A screenshot of the Mitel Web UI Preferences page, specifically the General tab. The page has a title "Preferences" and a sub-tab "General" which is highlighted. Below the sub-tab, there is a list of settings. Each setting has a label on the left and a control on the right. The settings are: Park Call (text input), Pick Up Parked Call (text input), Display DTMF Digits (checkbox checked, label "Enabled"), Play Call Waiting Tone (checkbox checked, label "Enabled"), Stuttered Dial Tone (checkbox checked, label "Enabled"), XML Beep Support (checkbox checked, label "Enabled"), Status Scroll Delay (seconds) (text input with value "5"), Switch UI Focus To Ringing Line (checkbox checked, label "Enabled"), Call Hold Reminder During Active Calls (checkbox checked, label "Enabled"), Call Hold Reminder (checkbox checked, label "Enabled"), Call Waiting Tone Period (text input with value "0"), Preferred line (dropdown menu with "None" selected), Preferred line Timeout (seconds) (text input with value "0"), Goodbye Key Cancels Incoming Call (checkbox unchecked, label "Enabled"), Message Waiting Indicator Line (dropdown menu with "All" selected), DND Key Mode (dropdown menu with "Custom" selected), and Call Forward Key Mode (dropdown menu with "Custom" selected).

2. In the **Call Waiting Tone Period** field, enter a time period, in seconds, that the call waiting tone will be audible on an active call when another call comes in. Default is 0 seconds. When enabled, the call waiting tone plays at regular intervals for the amount of time set for this parameter. For example, if set to 30 the call waiting tone plays every 30 seconds. When set to 0, the call waiting tone is audible only once on the active call.
3. Click **Save Settings**.

PREFERRED LINE AND PREFERRED LINE TIMEOUT

The 6867i has two parameters called preferred line and preferred line timeout. If you enable the preferred line parameter on your phone, after a call ends (incoming or outgoing), the display switches back to the preferred line. Next time you go off-hook to make another call, you pickup on the preferred line. You can enable the **Preferred Line** parameter using the Mitel Web UI at the location, *Basic Settings > Preferences > General*. You can also set a **Preferred Line Timeout** parameter that specifies the number of seconds it takes for the phone to switch back to the preferred line.

The following table provides the behavior of the preferred line focus feature with other features on the phone:

PHONE FEATURE	PREFERRED LINE BEHAVIOR
Last Call Return	The phone switches back to the focused line immediately after the call ends.
Speeddial	The line is already specified when the speed dial is created. The phone switches back immediately after the call ends.
Conference	For incoming calls, the phone switches back immediately after the call ends.
Transfer	For incoming or outgoing calls, the current behavior is that the same line used to transfer the call does not change. For incoming calls, the phone switches back immediately after the call transfers.
Park	The phone switches back immediately after the call ends.
Voicemail	The phone switches back immediately after the call ends.
Outgoing Redial	The phone switches back immediately after the call ends.
Dialing	For incomplete dialing on a non-preferred line, the focus does not change if some digits are entered. If no digits are entered or digits were cleared, the focus changes to preferred line after the time out has passed without activities.
Caller ID	If the Switch UI Focus To Ringing Line parameter is disabled, the User is able to see the Caller ID when the phone switches the focus to the ringing line.
Factory Default	Factory default and recovery mode clears the preferred line and preferred line timeout parameters, and the phone operates in a non-preferred line mode.



Notes:

1. If you specify a value of 0 for the **Preferred Line** parameter, it disables the preferred line focus feature.
2. If you specify a value of 0 for the **Preferred Line Timeout** parameter, the phone returns the line to the preferred line immediately.

CONFIGURING PREFERRED LINE AND PREFERRED LINE TIMEOUT

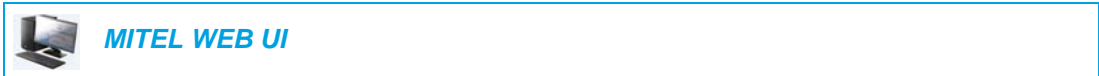

1. Click on **Basic Settings > Preferences > General**.

Preferences

General

Park Call:	<input type="text"/>
Pick Up Parked Call:	<input type="text"/>
Display DTMF Digits	<input checked="" type="checkbox"/> Enabled
Play Call Waiting Tone	<input checked="" type="checkbox"/> Enabled
Stuttered Dial Tone	<input checked="" type="checkbox"/> Enabled
XML Beep Support	<input checked="" type="checkbox"/> Enabled
Status Scroll Delay (seconds)	<input type="text" value="5"/>
Switch UI Focus To Ringing Line	<input checked="" type="checkbox"/> Enabled
Call Hold Reminder During Active Calls	<input checked="" type="checkbox"/> Enabled
Call Hold Reminder	<input checked="" type="checkbox"/> Enabled
Call Waiting Tone Period	<input type="text" value="0"/>
Preferred line	<input type="text" value="None"/>
Preferred line Timeout (seconds)	<input type="text" value="0"/>
Goodbye Key Cancels Incoming Call	<input type="checkbox"/> Enabled
Message Waiting Indicator Line	<input type="text" value="All"/>
DND Key Mode	<input type="text" value="Custom"/>
Call Forward Key Mode	<input type="text" value="Custom"/>



2. In the **Preferred Line** field, select a preferred line to switch focus to after incoming or outgoing calls end on the phone. Default is 1. Valid values are:
 - None (disables the preferred line focus feature)
 - 1 through 24.

For example, if you set the preferred line to 2, when a call (incoming or outgoing) ends on the phone (on any line), the phone switches focus back to Line 2.

3. In the **Preferred Line Timeout** field, enter the amount of time, in seconds, that the phone switches back to the preferred line after a call (incoming or outgoing) ends on the phone, or after a duration of inactivity on an active line. Default is 0. Valid values are: 0 to 999
4. Click **Save Settings**.

GOODBYE KEY CANCELS INCOMING CALLS

The 6867i has a feature that allows you to configure the **Goodbye** key to drop a second incoming call or ignore incoming calls presented to the phone when you are on an active call. The parameter is called **Goodbye Key Cancels Incoming Call** and is configurable via the Mitel Web UI.

If you enable this parameter, which is the default, pressing the  key rejects calls coming into the phone while you are on an active call. When you disable this parameter, pressing the  key hangs up the active call.

CONFIGURING GOODBYE KEY TO CANCEL INCOMING CALLS



MITEL WEB UI

1. Click on **Basic Settings > Preferences > General**.

Preferences

General

Park Call:	<input type="text"/>
Pick Up Parked Call:	<input type="text"/>
Display DTMF Digits	<input checked="" type="checkbox"/> Enabled
Play Call Waiting Tone	<input checked="" type="checkbox"/> Enabled
Stuttered Dial Tone	<input checked="" type="checkbox"/> Enabled
XML Beep Support	<input checked="" type="checkbox"/> Enabled
Status Scroll Delay (seconds)	<input type="text" value="5"/>
Switch UI Focus To Ringing Line	<input checked="" type="checkbox"/> Enabled
Call Hold Reminder During Active Calls	<input checked="" type="checkbox"/> Enabled
Call Hold Reminder	<input checked="" type="checkbox"/> Enabled
Call Waiting Tone Period	<input type="text" value="0"/>
Preferred line	<input type="text" value="None"/> ▼
Preferred line Timeout (seconds)	<input type="text" value="0"/>
Goodbye Key Cancels Incoming Call	<input type="checkbox"/> Enabled
Message Waiting Indicator Line	<input type="text" value="All"/> ▼
DND Key Mode	<input type="text" value="Custom"/> ▼
Call Forward Key Mode	<input type="text" value="Custom"/> ▼

2. The **Goodbye Key Cancels Incoming Call** field is enabled by default. To disable this field, uncheck the box.
3. Click **Save Settings** to save your settings.

MESSAGE WAITING INDICATOR

You can configure the Message Waiting Indicator (MWI) to illuminate for a specific line or for all lines. For example, if you configure the MWI LED on Line 2 only, the LED illuminates if a voicemail is pending on Line 2. If you configure the MWI LED for all lines, the LED illuminates if a voicemail is pending on any line on the phone (lines 1 through 24).

You configure the MWI using the Mitel Web UI.

CONFIGURING MESSAGE WAITING INDICATOR



1. Click on **Basic Settings > Preferences > General**.

A screenshot of the Mitel Web UI Preferences page, General tab. The page has a title "Preferences" and a sub-tab "General". The settings are as follows:

Park Call:	<input type="text"/>
Pick Up Parked Call:	<input type="text"/>
Display DTMF Digits	<input checked="" type="checkbox"/> Enabled
Play Call Waiting Tone	<input checked="" type="checkbox"/> Enabled
Stuttered Dial Tone	<input checked="" type="checkbox"/> Enabled
XML Beep Support	<input checked="" type="checkbox"/> Enabled
Status Scroll Delay (seconds)	<input type="text" value="5"/>
Switch UI Focus To Ringing Line	<input checked="" type="checkbox"/> Enabled
Call Hold Reminder During Active Calls	<input checked="" type="checkbox"/> Enabled
Call Hold Reminder	<input checked="" type="checkbox"/> Enabled
Call Waiting Tone Period	<input type="text" value="0"/>
Preferred line	<input type="text" value="None"/> ▼
Preferred line Timeout (seconds)	<input type="text" value="0"/>
Goodbye Key Cancels Incoming Call	<input type="checkbox"/> Enabled
Message Waiting Indicator Line	<input type="text" value="All"/> ▼
DND Key Mode	<input type="text" value="Custom"/> ▼
Call Forward Key Mode	<input type="text" value="Custom"/> ▼

2. The **Message Waiting Indicator Line** field is set to **ALL** lines by default. If required, change the setting to a specific line by selecting a line from the list. Valid values are **All** and lines **1** through **24**.
3. Click **Save Settings**.

INCOMING INTERCOM CALL FEATURES

By default, the IP phone allows incoming intercom calls to be automatically answered without having to set up an Icom key on your phone. The phone automatically plays a warning tone when it receives an incoming intercom call. It also mutes the microphone. If the intercom call comes into the phone while an active call is already present, the phone puts the active call on hold and answers the intercom call.

You can change the behavior of how the phone handles incoming intercom calls by enabling/disabling the following parameters using the Mitel Web UI:

- Auto Answer
- Microphone Mute
- Play Warning Tone
- Allow Barge In

AUTO-ANSWER/PLAY WARNING TONE

The auto-answer feature on the IP phone allows you to enable or disable automatic answering for an Intercom call. If **Auto-Answer** is enabled, the phone automatically answers an incoming intercom call. If **Play Warning Tone** is also enabled, the phone plays a tone to alert you before answering the intercom call. If **Auto-Answer** is disabled, the phone treats the incoming intercom call as a normal call. **Auto-Answer** and **Play Warning Tone** are enabled by default.



Note: Your Administrator can set a time period delay before the phone automatically answers. Contact your System Administrator for more information.

MICROPHONE MUTE

You can mute or unmute the microphone on the IP phone for intercom calls made by the originating caller. If you want to mute the intercom call, you enable this feature. If you want to unmute (or hear the intercom call), you disable this feature. **Microphone Mute** is enabled by default.

ALLOW BARGE IN

You can configure whether or not the IP phone allows an incoming intercom call to interrupt an active call. The **Allow Barge In** parameter controls this feature. When you enable this parameter, which is the default value, an incoming intercom call takes precedence over any active call, by placing the active call on hold and automatically answering the intercom call. When you disable this parameter, and there is an active call, the phone treats an incoming intercom call like a normal call and plays the call warning tone. **Allow Barge In** is enabled by default.

CONFIGURING INCOMING INTERCOM SETTINGS



1. Click on **Basic Settings > Preferences > Incoming Intercom Settings**.



2. The **Auto-Answer** field is enabled by default. The automatic answering feature is turned on for the IP phone for answering Intercom calls. To disable this field, uncheck the box.



Note: If the Auto-Answer field is not checked (disabled), the phone treats the incoming intercom call as a normal call.

3. The **Microphone Mute** field is enabled by default. The microphone is muted on the IP phone for Intercom calls made by the originating caller. To disable this field, uncheck the box.
4. The **Play Warning Tone** field is enabled by default. If Auto-Answer is enabled, the phone plays a warning tone when it receives in incoming intercom call. To disable this field, uncheck the box.
5. The **Allow Barge In** field is enabled by default. If Allow Barge In is enabled, the phone puts an active call on hold and answers the incoming Intercom call. To disable this field, uncheck the box.
6. Click **Save Settings** to save your settings.

GROUP RTP PAGING

You can configure the phone to allow it to receive a Real Time Transport Protocol (RTP) stream from pre-configured multicast address(es) without involving SIP signaling. This is called Group Paging on the IP phones. You can specify up to 5 multicast addresses that the phone listens for on the network. This feature is configurable using the Mitel Web UI only.

The 6867i in the local network listens for RTP on the pre-configured multicast address. The Phone displays the Paging message to the phone's LCD. It uses the G711 uLaw CODEC for multicast RTP.

The recipient can drop the incoming page if required. The recipient can also set DND to ignore any incoming pages.

For incoming RTP multicasts, the ringing display is dependent on the setting for the **Allow Barge In** parameter (see “[Allow Barge In](#)” on [page ccix](#)). If this parameter is disabled, and there is no other call on the phone, then the paging is automatically played via the default audio device.

If there is an existing call on the phone, the call initially displays in the ringing state. The user has the option to accept/ignore the call. If the **Allow Barge In** parameter is enabled, the RTP multicast call barges in, and any existing calls are put on hold.

If an RTP multicast session already exists on the phone, and the phone receives another incoming RTP multicast session, the priority is given to the first multicast session and the second multicast session is ignored. The behavior for the incoming calls in this case is also based on the setting for the **Allow Barge In** parameter. The incoming call is handled as if there were an existing call already on the phone.

CONFIGURING GROUP RTP PAGING



MITEL WEB UI

1. Click on **Basic Settings > Preferences > Group Paging RTP Settings**.

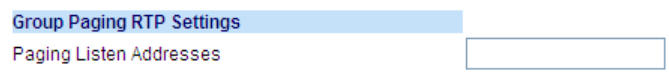

2. In the **Paging Listen Addresses** text box, enter the multicast IP address(es) and port number on which the phone listens for incoming multicast RTP packets.
Enter the IP address in dotted decimal format (for example, 239.0.1.15:10000,239.0.1.20:15000)
You can enter up to 5 listening multicast addresses.
If this field is blank, the paging listening capability is disabled on the phone.



Notes:

1. Recipient of a paging call can set a global DND to ignore any incoming pages.
2. For incoming paging, the phone uses the Intercom configuration settings. The incoming page is dependent on the **Allow Barge In** parameter setting and the idling/on call state

3. Click **Save Settings**.

SHARED CALL APPEARANCE (SCA) CALL BRIDGING

Shared Call Appearance (SCA) is when incoming calls are presented to multiple phones simultaneously. For example, it is the ability to assign the boss' extension to a button on the secretary's phone. Calls can be transferred between two phones with the same extension button by simply putting the call on hold at one phone and picking it up on the other. Status LEDs light and flash in unison, allowing all people sharing the extension to see the status at a glance.

The phones include an enhanced SCA for the call managers that support call bridging and allows two or more SCA users to be connected in a call with a third party.

Refer to the following example.

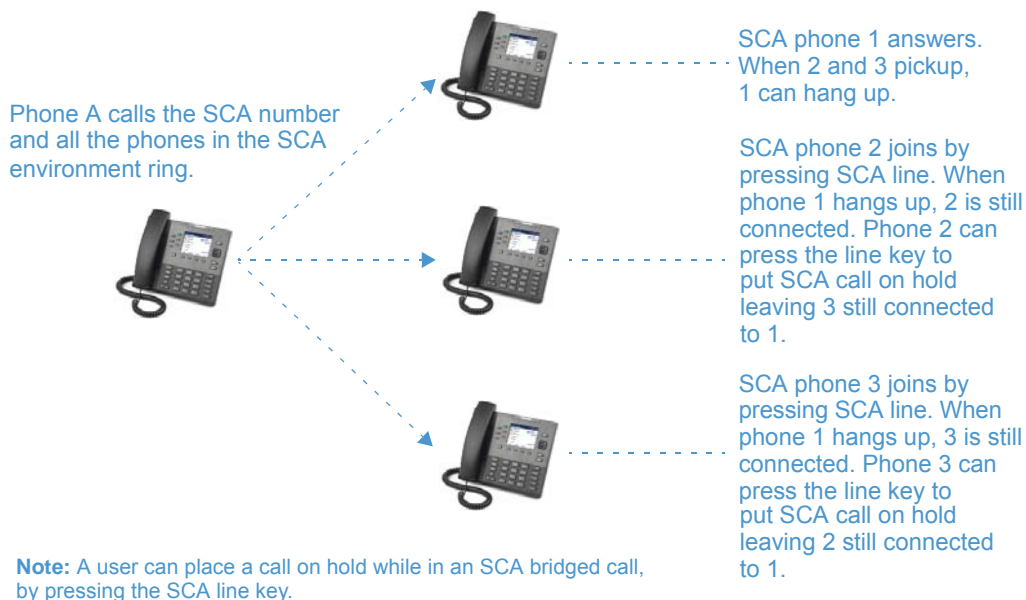

Using the example above, when a call comes into Phone 1, Phone 2 and Phone 3 can pickup the same call by pressing the SCA line key. Phone 2 and 3 display the call they are bridging into on the LCD of the phones. Existing SCA parties in a bridge or one-to-one call hear an audible beep when another party has joined the call.



Note: Your Administrator must enable/disable the beep on the server-side.

If a phone is configured for SCA bridging and it attempts to join a call, but the account on the server does not have this functionality enabled, an error message displays to the LCD on the phone.

The SCA call bridging feature is disabled by default on all phones. Your Administrator can enable/disable this feature if required. Contact your System Administrator for more information.

Keys States and LED/Button Behavior

There are two call states on the phones that support SCA bridging:

- **Bridge-active** - A bridged call is in progress
- **Bridge-held** - The 3rd-party (i.e., non-SCA party) in the bridge is on hold.

The following tables provide the key states and LED/image behavior in an SCA bridge call for users involved in an SCA call (local) and users not involved in the SCA call (remote).

Line Keys

STATE	LINE LED FOR LOCAL	LINE LED FOR REMOTE
Idle	Off	Off
Seized	Solid Green	Solid Red
Progressing (outgoing call)	Green	Solid Red
Alerting (incoming call)	Flashing Red	Off
Active	Solid Green	Solid Red
Held	Slow Flashing Green	Slow Flashing Red
Hold Private	Slow Flashing Green	Solid Red
Bridge-Active	Solid Green	Solid Red
Bridge-Held	Slow Flashing Green	Solid Red

Softkeys

State	Softkey Image for Local	Softkey LED for Local	Softkey Image for Remote	Softkey LED for Remote
Idle		Off		Off
Seized		Solid Red		Solid Red
Progressing (outgoing call)		Solid Red		Solid Red
Alerting (incoming call)		Flashing Red		N/A
Active		Solid Red		Solid Red
Held		Slow Flashing Red		Slow Flashing Red
Hold Private		Slow Flashing Red		Solid Red
Bridge-Active		Solid Red		Solid Red
Bridge-Held		Slow Flashing Red		Solid Red

SCA VOICEMAIL INDICATORS

Visual indicators for voicemail messages on SCA lines can be enabled by your System Administrator. When an SCA-configured line has a pending voicemail message, your Administrator has the option of configuring the phone to display the number of pending messages beside the softkey's label corresponding to the line. Additionally, the softkey's LED will be illuminated. Contact your System Administrator for more information.

BROADSOFT BROADWORKS EXECUTIVE AND ASSISTANT SERVICES

The IP phone supports the BroadSoft BroadWorks Executive and Assistant Services feature. The Executive and Assistant Services feature allows for an inter-network relationship to be created between Executives and Assistants allowing calls to the Executive's phone to be screened, filtered, and routed to an Assistant, whereby the Assistant can answer, divert the filtered call, or push the call back to the Executive.



Note: Contact your System Administrator for feature availability details and additional information on how to configure and use the BroadSoft BroadWorks Executive and Assistant Services feature.

FILTER SOFTKEY

A "Filter" key type is available allowing both Executives and Assistants the ability to easily activate and deactivate the Executive Call Filtering feature.



Note: Contact your System Administrator if you require assistance with regards to configuring the Filter key.

Filter Key for the Executive's Phone

The Executive's phone requires that only one Filter key be configured. The Filter key's value can either be left undefined or, it can be defined using the following values:

- Executive Call Filtering Activation FAC (e.g. "#61")
 - Used when the Deactivation FAC is in the same format as the Activation FAC but sequentially one number above the Activation FAC. For example, if the key value is defined as "#61" (the Activation FAC), the phone will automatically assume that the Deactivation FAC is "#62" and will use that code to deactivate Executive Call Filtering.
- Executive Call Filtering Activation FAC followed by a semi-colon and then Executive Call Filtering Deactivation FAC (e.g. "#61;*61" or "#61;#71")
 - Used when the Activation and Deactivation FACs are not in the same format or when they are not sequential. For example, if the Activation FAC is configured in the BroadSoft BroadWorks Web portal is "#61" and the Deactivation FAC is configured as "*61" or "#71", the key value should be defined with the two specific FACs separated by a semi-colon (i.e. "#61;*61" or "#61;#71" respectively).



Notes:

1. If the Deactivation FAC is not specified after the semi-colon (e.g. "#61;"), the phone will ignore the semi-colon and behave as if only the Activation FAC was defined (i.e. the phone will automatically assume that the Deactivation FAC is in the same format but sequentially one number above the Activation FAC).
2. The IP phones support Executive Call Filtering Activation/Deactivation FACs that contain the prefix "#" or "*".

Irrespective of a defined or undefined key value, when the Filter key is pressed, Executive Call Filtering will be activated and the key's corresponding LED will be lit. When the Filter key is

pressed again, Executive Call Filtering will deactivate and the key’s corresponding LED will turn off.



Note: Upon a reboot, the initial state of the Filter key LED will correspond to the Executive Call Filtering state configured on the call manager.

Configuring the Filter Key on the Executive’s Phone Using the Mitel Web UI

Use the following procedure to configure the Filter key on the Executive’s phone using the Mitel Web UI:

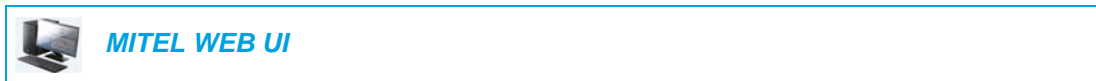

1. Click on **Operation->Softkeys and XML.**
or
Click on **Operation->Expansion Module Keys.**

Softkeys Configuration

Bottom Keys | Top Keys

Key	Type	Label	Value	Line
1	Filter			1
2	None			1
3	None			1
4	None			1
5	None			1

2. Select a key that you want to use as a Filter activate/deactivate key.
3. In the "**Type**" field, select "**Filter**".
4. In the "**Label**" field, enter a label to apply to this key (e.g. Filter).
5. (Optional) In the "**Value**" field, enter the Executive Call Filtering Activation FAC (e.g. #61) or both the Executive Call Filtering Activation and Deactivation FACs followed by a semi-colon (e.g. #61;*61).
6. In the "**Line**" field, select the line for which you want to use the key functionality.
7. Click **Save Settings** to save your settings.

Filter Key for the Assistant’s Phone

As an Assistant can be associated with multiple Executives simultaneously, the Assistant’s phone can be configured with multiple Filter softkeys; one softkey for each Executive. In this case, the value of each Filter softkey should correspond to the phone number or extension of the respective Executive as per configured in the user’s profile.

When Filter softkeys are configured with key values, pressing the respective Filter softkey will activate Executive Call Filtering for the applicable Executive and the softkey’s corresponding

LED will be lit. When the same Filter softkey is pressed again, Executive Call Filtering for the applicable Executive will deactivate and the softkey's corresponding LED will turn off.

Alternatively, a single Filter softkey can be configured without a defined key value. If this is the case, the Assistant will be able to manually activate and deactivate Executive Call Filtering for each associated Executive through the phone's UI. In this scenario, as only one Filter softkey is utilized, the softkey's corresponding LED will be lit when Executive Call Filtering is activated for even one associated Executive. If Executive Call Filtering is disabled for all associated Executives, the softkey's corresponding LED will turn off.



Note: If Call Forward is enabled for filtered calls, LEDs for all Filter softkeys will be turned off.

Configuring the Filter Key on the Assistant's Phone Using the Mitel Web UI

Use the following procedure to configure the Filter key on the Assistant's phone using the Mitel Web UI:



MITEL WEB UI

1. Click on **Operation->Softkeys and XML**.
or
Click on **Operation->Expansion Module Keys**.

Softkeys Configuration

Bottom Keys		Top Keys		
Key	Type	Label	Value	Line
1	Filter	Filter-Stefan	4100	1
2	None			1
3	None			1
4	None			1
5	None			1

2. Select a key that you want to use as a Filter activate/deactivate key.
3. In the "**Type**" field, select "**Filter**".
4. In the "**Label**" field, enter a label to apply to this key (e.g. "Filter-Stefan" for a specific Executive or simply "Filter" for a generic Filter key with no defined value).



Note: To utilize a single Filter softkey without a defined key value (so that you can manually activate and deactivate Executive Call Filtering through the phone's UI) skip to Step 8.

5. In the "**Value**" field, enter the Executive's phone or extension number (e.g. 4100)
6. In the "**Line**" field, select the line for which you want to use the key functionality.
7. Repeat Steps 2 to 6 for each respective Executive for whom you would like to assign a Filter key.

8. Click **Save Settings** to save your settings.

SPEEDDIAL KEY WITH INITIATE CALL FUNCTIONALITY (ASSISTANTS ONLY)

Speeddial keys can be configured to efficiently utilize the Executive-Assistant Initiate Call function. With a Speeddial key configured for this feature, Assistants can initiate a call on behalf of an Executive, whereby the call will appear to the target as one originated by the Executive himself/herself. The Speeddial key's value can be defined using the following syntax:

- Executive-Assistant Initiate Call FAC (e.g. #64):
 - In such scenarios, the call manager will play an audible prompt asking you to enter the Executive's Address and Destination Address manually using the keypad.
- Executive-Assistant Initiate Call FAC followed by the Executive's Address (e.g. #644052):
 - In such scenarios, only the Destination Address will need to be manually entered using the keypad.
- Executive-Assistant Initiate Call FAC, followed by the Executive's Address, an asterisk, and then the Destination Address (e.g. #644052*4059):
 - In such scenarios, addresses will not need to be manually entered and the phone will automatically initiate the call to the target phone on behalf of the Executive.



Notes:

1. Contact your System Administrator if you require assistance with regards to configuring the Speeddial key with the Initiate Call functionality.
2. The Speeddial key type can be utilized for additional functions related to the Executive and Assistant Services feature that rely on FAC calls (i.e. opting in to an Executive's filtered call pool, opting out of an Executive's filtered call pool, etc...). Contact your System Administrator for further details.

Configuring the Initiate Call Key on an Assistant's Phone Using the Mitel Web UI

Use the following procedure to configure the Initiate Call Key on an Assistant's phone using the Mitel Web UI:

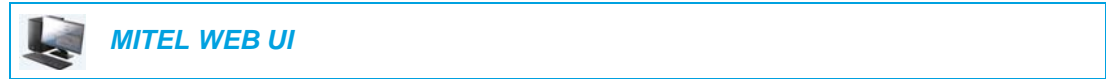

1. Click on **Operation->Softkeys and XML**.
or
Click on **Operation->Expansion Module Keys**.

Softkeys Configuration

Key	Type	Label	Value	Line
1	Speeddial	Init	#644052*4059	1
2	None			1
3	None			1
4	None			1
5	None			1

2. Select a key that you want to use as an Initiate Call key.
3. In the "**Type**" field, select "**Speeddial**".
4. In the "**Label**" field, enter a label to apply to this key (e.g. Init).
5. In the "**Value**" field, enter the Initiate Call FAC (e.g. #64)
or
In the "**Value**" field, enter the Initiate Call FAC, followed by the Executive's Address (e.g. #644052)
or
In the "**Value**" field, enter the Initiate Call FAC, the Executive's Address, followed by an asterisk, and then the Destination Address (e.g. #644052*4059)
6. In the "**Line**" field, select the line for which you want to use the key functionality.
7. Click **Save Settings** to save your settings.

EXECUTIVE PHONE FEATURES

Users with phones assigned with the Executive role are able to:

- Activate and deactivate the Executive Call Filtering service from the phone
- Intercept or ignore filtered calls before they are transferred to the Assistant

To Activate Executive Call Filtering on an Executive's Phone

Use the following procedure to activate Executive Call Filtering on an Executive's Phone:



IP PHONE UI

1. Press the configured **"Filter"** key.
Executive Call Filtering is now activated and the key's corresponding LED will be lit.

To Deactivate Executive Call Filtering on an Executive's Phone

Use the following procedure to deactivate Executive Call Filtering on an Executive's Phone:



IP PHONE UI

1. Press the configured **"Filter"** key.
Executive Call Filtering is now deactivated and the key's corresponding LED will be turned off.

To Intercept a Filtered Call Before it is Transferred to an Assistant

Use the following procedure to intercept a filtered call before it is transferred to an Assistant:



IP PHONE UI

1. Lift the handset, press the  button, or press the **Answer** softkey if the phone has no active calls
or
Press the **Answer** softkey if on an active call.

To Ignore a Filtered Call

Use the following procedure to ignore a filtered call:



IP PHONE UI

1. Press the  button or **Ignore** softkey if the phone has no active calls
or
Press the **Ignore** softkey if on an active call.

ASSISTANT PHONE FEATURES

Users with phones assigned with the Assistant role are able to:

- Activate and deactivate the Executive Call Filtering service from the phone
- Answer or ignore a filtered call
- Push a filtered call back to the Executive
- Perform a blind transfer of a filtered call to the Executive
- Perform a semi-attended transfer of a filtered call to the Executive
- Perform a consultative transfer of a filtered call to the Executive
- Activate and deactivate call forwarding of the Executive's filtered calls
- Initiate a call on behalf of an Executive



Notes:

1. Push functionality does not carry over to the target phone when call forwarding of an Executive's filtered calls is enabled.
2. Assistants are also able to handle filtered calls in the same manner as unfiltered calls.

To Activate Executive Call Filtering on an Assistant's Phone when the Filter Key's Value is Defined

Use the following procedure to activate Executive Call Filtering on an Assistant's phone when the Filter key's value is defined:



IP PHONE UI

1. Press the configured "**Filter**" key corresponding to the respective Executive. Executive Call Filtering is now activated for that Executive and the key's corresponding LED will be lit.



Note: If Call Forward is enabled for filtered calls, LEDs for all Filter keys will be turned off.

To Activate Executive Call Filtering on an Assistant's Phone when the Filter Key's Value is Not Defined

Use the following procedure to activate Executive Call Filtering on an Assistant's phone when the Filter key's value is not defined:



IP PHONE UI

1. Press the "**Filter**" softkey.
The list of associated Executives will appear on screen.
2. Select the Executive for whom you want to activate Executive Call Filtering by pressing the ▲ and ▼ navigation keys and then pressing the button.

A checkmark will be displayed beside the Executive indicating Executive Call Filtering is to be activated.

3. Press the **Save** softkey.



Notes:

1. The LED corresponding to the **Filter** key will be lit if Executive Call Filtering is activated for any associated Executive. The LED will turn off if Executive Call Filtering is deactivated for all associated Executives.
2. If Call Forward is enabled for filtered calls, the LED for the Filter softkey will be turned off

To Deactivate Executive Call Filtering on an Assistant's Phone when the Filter Key's Value is Defined

Use the following procedure to deactivate Executive Call Filtering on an Assistant's phone when the Filter key's value is defined:

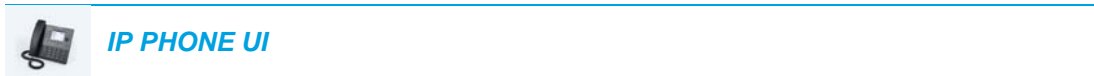

1. Press the configured **Filter** key corresponding to the respective Executive. Executive Call Filtering is now deactivated for that Executive and the key's corresponding LED will turn off.



Note: If Call Forward is enabled for filtered calls, LEDs for all Filter keys will be turned off.

To Deactivate Executive Call Filtering on an Assistant's Phone when the Filter Key's Value is Not Defined

Use the following procedure to deactivate Executive Call Filtering on an Assistant's phone when the Filter key's value is not defined:



1. Press the **Filter** key.
The list of associated Executives will appear on screen.
2. Select the Executive for whom you want to deactivate Executive Call Filtering by pressing the ▲ and ▼ navigation keys and then pressing the  button.
The checkmark will be removed beside the Executive indicating Executive Call Filtering is to be deactivated.
3. Press the **Save** softkey.



Notes:

1. The LED corresponding to the **Filter** key will be lit if Executive Call Filtering is activated for any associated Executive. The LED will turn off if Executive Call Filtering is deactivated for all associated Executives.
2. If Call Forward is enabled for filtered calls, the LED for the Filter softkey will be turned off.

To Answer a Filtered Call

Use the following procedure to answer a filtered call:

**IP PHONE UI**

1. Lift the handset, press the  button, or press the **Answer** softkey if the phone has no active call
or
Press the **Answer** softkey if on an active call.

To Ignore a Filtered Call

Use the following procedure to ignore a filtered call:

**IP PHONE UI**

1. Press the  button or **Ignore** softkey if the phone has no active calls
or
Press the **Ignore** softkey if on an active call.

To Push a Filtered Call Back to the Executive

Use the following procedure to push a filtered call back to the Executive:

**IP PHONE UI**

1. After answering a filtered call, press the **Push** softkey.
The phone will enter in the FAC for the BroadSoft Executive-Assistant Call Push feature and automatically dial the FAC call.
The FAC call will be answered and the filtered call will be released if the push is successful.



Note: If the push is unsuccessful, press the **Pickup** softkey to retrieve the filtered call.

To Perform a Blind Transfer of a Filtered Call to the Executive

Use the following procedure to perform a blind transfer of a filtered call to the Executive:

**IP PHONE UI**

1. After answering a filtered call, press the **Xfer** softkey.
2. Enter the Executive's phone or extension number and press the **Xfer** softkey.
The phone will recognize the Executive's number and will change the transfer scenario into an Executive-Assistant Call Push scenario (i.e. the phone will enter in the FAC for the

BroadSoft Executive-Assistant Call Push feature and automatically dial the FAC call). The FAC call will be answered and the filtered call will be released if the push is successful.



Note: If the push is unsuccessful, press the **Pickup** softkey to retrieve the filtered call.

To Perform a Semi-Attended Transfer of a Filtered Call to the Executive

Use the following procedure to perform a semi-attended transfer of a filtered call to the Executive:



IP PHONE UI

1. After answering a filtered call, press the **Xfer** softkey.
2. Enter the Executive's phone or extension number and press the **Dial** softkey.
3. When the call is in the ringing state, press the **Xfer** softkey.
The phone will recognize the Executive's number and will change the transfer scenario into an Executive-Assistant Call Push scenario (i.e. the phone will enter in the FAC for the BroadSoft Executive-Assistant Call Push feature and automatically dial the FAC call). The FAC call will be answered and the filtered call will be released if the push is successful.



Note: If the push is unsuccessful, press the **Pickup** softkey to retrieve the filtered call.

To Perform a Consultative Transfer of a Filtered Call to the Executive

Use the following procedure to perform a consultative transfer of a filtered call to the Executive:



IP PHONE UI

1. After answering a filtered call, press the **Xfer** softkey.
2. Enter the Executive's phone or extension number and press the **Dial** softkey.
3. When the call is answered by the Executive press the **Xfer** softkey.
The call will be transferred normally and the filtered call will be released.

To Activate Call Forwarding of Filtered Calls

Use the following procedure to activate call forwarding of filtered calls:



1. Click on **Basic Settings->Account Configuration**.

Account Configuration

Account	DND	Call Forward	State	Label	No. Rings
1. Susan Smith	<input type="checkbox"/>	All	<input type="checkbox"/>	<input type="text"/>	4 ▼
		Busy	<input type="checkbox"/>	<input type="text"/>	
		No Answer	<input type="checkbox"/>	<input type="text"/>	





Forward Filtering

Divert Enabled

Divert to Number

2. Place a checkmark in the **“Enabled”** box beside the **“Divert”** option under **“Forward Filtering”**.
3. Enter the phone number you wish to forward incoming filtered calls to in the **“Divert to Number”** field.
4. Click **Save Settings**.

 **IP PHONE UI**

1. Press the **Options** key and then navigate to the Call Forward menu or Press the **Call Forward** softkey.
2. Press the  navigation key until you reach the Forward Filtering number field.
3. Enter the applicable forwarding number.
4. Press the  navigation key to move to the **On** checkbox beside the Forward Filtering number field.
5. Press the  button.
A checkmark will be displayed indicating call forwarding of all filtered calls is to be activated.
6. Press the **Save** key to save your changes.
The idle screen status bar will display the Call Forward  icon and the MWI and (if configured) Call Forward softkey LEDs will be lit indicating Forward Filtering is activated.

To Deactivate Call Forwarding of Filtered Calls

Use the following procedure to deactivate call forwarding of filtered calls:

 **MITEL WEB UI**

1. Click on **Basic Settings->Account Configuration.**

Account Configuration

Account	DND	Call Forward	State	Label	No. Rings
1. Susan Smith	<input type="checkbox"/>	All	<input type="checkbox"/>		
		Busy	<input type="checkbox"/>		
		No Answer	<input type="checkbox"/>		4 ▼

Forward Filtering

Divert Enabled

Divert to Number

2. Remove the checkmark in the “**Enabled**” box beside the “**Divert**” option under “**Forward Filtering**”.
3. Click **Save Settings**.



IP PHONE UI

1. Press the **Options** key and then navigate to the Call Forward menu
or
Press the **Call Forward** softkey.
2. Press the ▲ navigation key until you reach the **On** checkbox beside the Forward Filtering number field.
3. Press the button.
The checkmark will be removed indicating call forwarding of all filtered calls is to be deactivated.
4. Press the **Save** key to save your changes.
The Call Forward  icon will be removed from the idle screen status bar and the MWI and (if configured) Call Forward softkey LEDs will turn off indicating Forward Filtering is deactivated.

To Initiate a Call on Behalf of an Executive

Use the following procedure to initiate a call on behalf of an Executive:



IP PHONE UI

1. Press the Speeddial softkey programmed with Initiate Call function (e.g. **“Init”**).
The phone will enter in the FAC for the BroadSoft Executive-Assistant Initiate Call feature and automatically dial the FAC call.
2. Follow any audible instructions (depending on the Speeddial key’s configuration you may be prompted to enter the Executive’s number/extension and/or Destination number/extension manually using the phone’s keypad).
The phone will automatically dial the Destination number/extension.
3. When the call is answered, if you would like to push the call to the Executive, press the **Push** key.
The phone will enter in the FAC for the BroadSoft Executive-Assistant Call Push feature and automatically dial the FAC call.
The FAC call will be answered and the filtered call will be released if the push is successful.

STAR CODES

All of the main call handling and extension management features using star codes can be set on your phone by your Administrator. Contact your System Administrator for more information.

If these have not been set up, you can dial any star code commands on the 6867i phone the same way you would on a regular telephone.

OTHER FEATURES

A multitude of other features are available depending on whether or not your System Administrator has configured them for use. Contact your System Administrator for feature availability and usage information.

MODEL M680I AND M685I EXPANSION MODULES

The 6867i IP phone offers two optional expansion modules that attach to the right side of the phone to provide additional programmable keys.

M680i Expansion Module

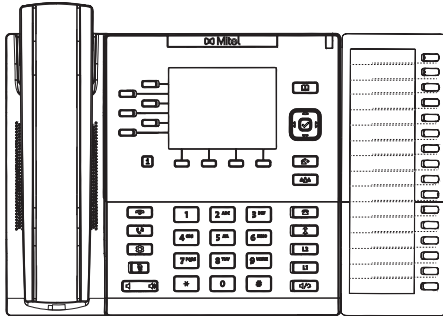

M685i Expansion Module

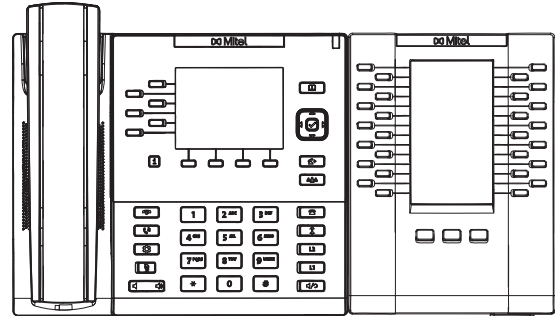

The M680i provides 16 softkeys, with each softkey providing an LED for call status indication. The M680i provides a paper label for convenient key labelling.

The M685i provides three pages of 28 softkeys (for a total of 84 programmable softkeys), with each softkey providing an LED and graphical UI for call status indication. The M685i features a 4.3" 480x272 pixel color backlit LCD display.

The M680i and M685i Expansion Module keys support the following functions:

- None
- Line
- Speed Dial
- Do Not Disturb (DND)
- Busy Lamp Field (BLF)
- BLF/List
- Auto Call Distribution (ACD)
- Extensible Markup Language (XML)
- Flash
- Sprecode
- Park
- Pickup
- Last Call Return
- Call Forward
- BLF/Xfer
- Speed Dial/Xfer
- Speed Dial/Conf
- Speed Dial/MWI
- Directory
- Filter
- Callers List
- Redial
- Conference
- Transfer
- Intercom (Icom)
- Phone Lock
- Paging
- Login
- Discreet Ringing
- Call History
- Empty

You can configure the keys using the Mitel Web UI at the path, *Operation > Expansion Module <N>* when an Expansion Module is attached to the 6867i IP phone.



Note: For more information about configuring the expansion module keys with these functions, see the “[Configuring Softkeys](#)” on [page lxxx](#).

USING THE EXPANSION MODULES

After configuring the softkeys on the respective expansion module press the key you want to use when applicable (for the M680i Expansion Module you can record the name of the key on the provided paper labels).

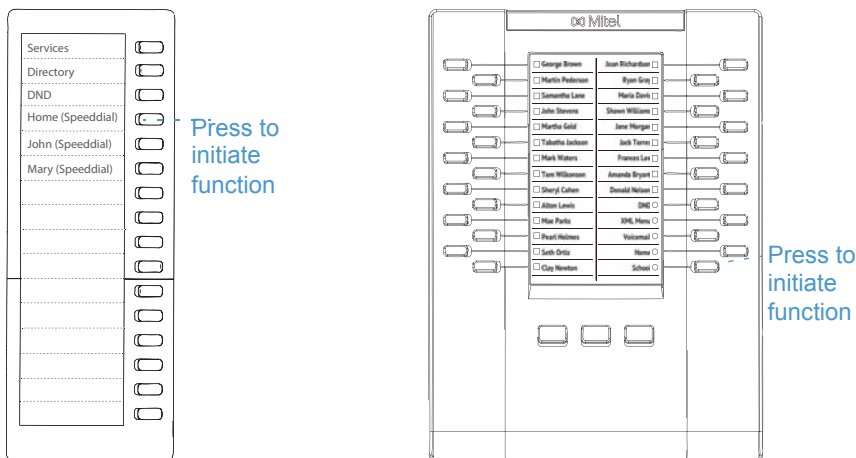

Note: For more information about installing the M680i or M686i Expansion Modules on your phone, see the *Mitel M680i Expansion Module Quick Start Guide/Mitel M685i Expansion Module Quick Start Guide* and *Mitel M680i Expansion Module Installation Guide/Mitel M685i Expansion Module Installation Guide*.

PRESS-AND-HOLD TO CREATE A SPEED DIAL KEY



You can press and hold an expansion module key to create a speed dial key and configure it the same way you configure a speed dial key on the phone. For details on creating a speed dial key, see “[Speed Dial Key](#)” on [page lxxxvii](#).

TROUBLESHOOTING SOLUTIONS

WHY IS MY DISPLAY BLANK?

Ensure that power is being provided to your phone. If your network does not provide inline power over Ethernet, you can obtain an additional accessory, the Mitel PoE (Power over Ethernet) inline power supply, to provide power over Ethernet locally to your phone. See the **Connecting to the Network and to Power** section in the *Mitel 6867i Installation Guide* for details.

WHY IS MY SPEAKERPHONE NOT WORKING?

If you press the  button and the speaker light flashes and you do not hear dial tone through the speaker, the **Audio Mode** option in the phone has been set up for headset use. Press  a second time and if the light goes out, the phone has been set up to be used only with a headset or handset. If the light stays on steady and you hear a dial tone, the phone has been set up so that you can alternate between the speakerphone and the headset by pressing . See “Audio Mode” on page lxiii for instructions on how to change the **Audio Mode** option.

WHY CAN'T I GET A DIAL TONE?

Check for any loose connections and that the phone has been installed properly. For installation instructions, please refer to the **Installation and Setup** section in the *Mitel 6867i Installation Guide*.

WHY DOESN'T MY PHONE RING?

Check the ring volume on your phone. It may be turned down or turned off. To adjust the ringer volume setting, press the volume button when the phone is on-hook and idle.

WHY IS THE LIGHT NOT COMING ON WITH A NEW VOICEMAIL MESSAGE?

Your phone system or service provider must provide the visual message waiting service for this function to work. Check with your System Administrator for more information.

WHY IS MY HANDSET NOT WORKING?

Check to ensure that the handset cord is fully connected to both the phone and handset. See the **Connecting a Handset or Headset** section in the *Mitel 6867i Installation Guide* for information.

HOW DO I FIND THE IP ADDRESS OF MY PHONE?

Instructions on where to find the IP address of your phone can be found in [“Finding Your Phone’s IP Address”](#) on [page xxxiv](#).

WHY DOES MY PHONE DISPLAY THE NO SERVICE MESSAGE?

The phone displays the **No Service** message if the SIP settings have not been set up correctly. Contact your System Administrator for more information.

HOW DO I CHANGE MY USER PASSWORD?

You can change the user password from the IP phone UI or the Mitel Web UI. See [“Password”](#) on [page lviii](#) and [“Configuring Lock Settings Using the Mitel Web UI”](#) on [page lx](#) for more information.

WHY DOES MY PHONE DISPLAY BAD ENCRYPTED CONFIG?

The IP phone displays **Bad Encrypted Config** because encrypted configuration files are enabled but the decryption process has failed. Report this error to your System Administrator.

HOW DO I RESTART THE IP PHONE?

You can restart the phone from the IP phone UI or through the Mitel Web UI. See [“Restarting Your Phone Using the IP Phone UI”](#) on [page lxxv](#) and [“Restarting Your Phone Using the Mitel Web UI”](#) on [page lxxv](#) for more information.

HOW DO I LOCK MY PHONE?

You can lock your phone to prevent the phone from being used or configured. You can lock the phone using any of the following:

- At the path *Options > Phone Lock* on the IP phone UI. See [“Phone Lock”](#) on [page lviii](#) for more information.
- At the path *Operations > Phone Lock* on the Mitel Web UI. See [“Configuring Lock Settings Using the Mitel Web UI”](#) on [page lx](#) for more information.
- At a configured key on the phone. For more information about configuring a Lock/Unlock key on your phone, see [“Paging Key”](#) on [page cxxxi](#).

LIMITED WARRANTY

(Not applicable in Australia – see below for Limited Warranty in Australia)

Mitel warrants this product against defects and malfunctions in accordance with Mitel's authorized, written functional specification relating to such products during a one (1) year period from the date of original purchase ("Warranty Period"). If there is a defect or malfunction, Mitel shall, at its option, and as the exclusive remedy, either repair or replace the product at no charge, if returned within the Warranty Period. If replacement parts are used in making repairs, these parts may be refurbished, or may contain refurbished materials. If it is necessary to replace the product, it may be replaced with a refurbished product of the same design and color. If it should become necessary to repair or replace a defective or malfunctioning product under this warranty, the provisions of this warranty shall apply to the repaired or replaced product until the expiration of ninety (90) days from the date of pick up, or the date of shipment to you, of the repaired or replacement product, or until the end of the original Warranty Period, whichever is later. Proof of the original purchase date is to be provided with all products returned for warranty repairs.

EXCLUSIONS

Mitel does not warrant its products to be compatible with the equipment of any particular telephone company. This warranty does not extend to damage to products resulting from improper installation or operation, alteration, accident, neglect, abuse, misuse, fire or natural causes such as storms or floods, after the product is in your possession. Mitel will not accept liability for any damages and/or long distance charges, which result from unauthorized and/or unlawful use.

Mitel shall not be liable for any incidental or consequential damages, including, but not limited to, loss, damage or expense directly or indirectly arising from the customer's use of or inability to use this product, either separately or in combination with other equipment. This paragraph, however, shall not apply to consequential damages for injury to the person in the case of products used or bought for use primarily for personal, family or household purposes.

This warranty sets forth the entire liability and obligations of Mitel with respect to breach of warranty, and the warranties set forth or limited herein are the sole warranties and are in lieu of all other warranties, expressed or implied, including warranties or fitness for particular purpose and merchantability.

WARRANTY REPAIR SERVICES

Should the product fail during the Warranty Period;

- **In North America**, please call 1-800-574-1611 for further information.
- **Outside North America**, contact your sales representative for return instructions.

You will be responsible for shipping charges, if any. When you return this product for warranty service, you must present proof of purchase.

AFTER WARRANTY SERVICE

Mitel offers ongoing repair and support for this product. This service provides repair or replacement of your Mitel product, at Mitel's option, for a fixed charge. You are responsible for all shipping charges. For further information and shipping instructions:

- **In North America**, contact our service information number: 1-800-574-1611.
- **Outside North America**, contact your sales representative.



Note: Repairs to this product may be made only by the manufacturer and its authorized agents, or by others who are legally authorized. This restriction applies during and after the Warranty Period. Unauthorized repair will void the warranty.

LIMITED WARRANTY (AUSTRALIA ONLY)

The benefits under the Mitel Limited Warranty below are in addition to other rights and remedies to which you may be entitled under a law in relation to the products.

In addition to all rights and remedies to which you may be entitled under the *Competition and Consumer Act 2010* (Commonwealth) and any other relevant legislation, Mitel warrants this product against defects and malfunctions in accordance with Mitel's authorized, written functional specification relating to such products during a one (1) year period from the date of original purchase ("Warranty Period"). If there is a defect or malfunction, Mitel shall, at its option, and as the exclusive remedy under this limited warranty, either repair or replace the product at no charge, if returned within the Warranty Period.

REPAIR NOTICE

To the extent that the product contains user-generated data, you should be aware that repair of the goods may result in loss of the data. Goods presented for repair may be replaced by refurbished goods of the same type rather than being repaired. Refurbished parts may be used to repair the goods. If it is necessary to replace the product under this limited warranty, it may be replaced with a refurbished product of the same design and color.

If it should become necessary to repair or replace a defective or malfunctioning product under this warranty, the provisions of this warranty shall apply to the repaired or replaced product until the expiration of ninety (90) days from the date of pick up, or the date of shipment to you, of the repaired or replacement product, or until the end of the original Warranty Period, whichever is later. Proof of the original purchase date is to be provided with all products returned for warranty repairs.

EXCLUSIONS

Mitel does not warrant its products to be compatible with the equipment of any particular telephone company. This warranty does not extend to damage to products resulting from improper installation or operation, alteration, accident, neglect, abuse, misuse, fire or natural causes such as storms or floods, after the product is in your possession. Mitel will not accept liability for any damages and/or long distance charges, which result from unauthorized and/or unlawful use.

To the extent permitted by law, Mitel shall not be liable for any incidental damages, including, but not limited to, loss, damage or expense directly or indirectly arising from your use of or inability to use this product, either separately or in combination with other equipment. This paragraph, however, is not intended to have the effect of excluding, restricting or modifying the application of all or any of the provisions of Part 5-4 of Schedule 2 to the Competition and Consumer Act 2010 (**the ACL**), the exercise of a right conferred by such a provision or any liability of Mitel in relation to a failure to comply with a guarantee that applies under Division 1 of Part 3-2 of the ACL to a supply of goods or services.

This express warranty sets forth the entire liability and obligations of Mitel with respect to breach of this express warranty and is in lieu of all other express or implied warranties other than those conferred by a law whose application cannot be excluded, restricted or modified. Our goods come with guarantees that cannot be excluded under the Australian Consumer Law. You are entitled to a replacement or refund for a major failure and for compensation for any other reasonably foreseeable loss or damage. You are also entitled to have the goods repaired or replaced if the goods fail to be of acceptable quality and the failure does not amount to a major failure.

WARRANTY REPAIR SERVICES

Procedure: Should the product fail during the Warranty Period and you wish to make a claim under this express warranty, please contact the Mitel authorized reseller who sold you this product (details as per the invoice) and present proof of purchase. You will be responsible for shipping charges, if any.

Manufacturer: Mitel Networks Corporation
745 Springvale Road
Mulgrave VIC 3170
ABN 16 140 787 195
Phone: +61 3 8562 2700

Limitation of Liability for Products not of a kind ordinarily acquired for personal, domestic or household use or consumption (e.g. goods/services ordinarily supplied for business-use)

- 1.1** To the extent permitted by law and subject to clause 1.2 below, the liability of Mitel to you for any non-compliance with a statutory guarantee or loss or damage arising out of or in connection with the supply of goods or services (whether for tort (including negligence), statute, custom, law or on any other basis) is limited to:
- a.** in the case of services:
 - i.** the resupply of the services; or
 - ii.** the payment of the cost of resupply; and
 - b.** in the case of goods:
 - i.** the replacement of the goods or the supply of equivalent goods; or
 - ii.** the repair of the goods; or
 - iii.** the payment of the cost of replacing the goods or of acquiring equivalent goods; or
 - iv.** the payment of the cost of having the goods repaired.
- 1.2** Clause 1.1 is not intended to have the effect of excluding, restricting or modifying:
- a.** the application of all or any of the provisions of Part 5-4 of Schedule 2 to the Competition and Consumer Act 2010 (**the ACL**); or
 - b.** the exercise of a right conferred by such a provision; or
 - c.** any liability of Mitel in relation to a failure to comply with a guarantee that applies under Division 1 of Part 3-2 of the ACL to a supply of goods or services.

AFTER WARRANTY SERVICE

Mitel offers ongoing repair and support for this product. If you are not otherwise entitled to a remedy for a failure to comply with a guarantee that cannot be excluded under the Australian Consumer Law, this service provides repair or replacement of your Mitel product, at Mitel's option, for a fixed charge. You are responsible for all shipping charges. For further information and shipping instructions contact:

Mitel Networks Corporation
745 Springvale Road
Mulgrave VIC 3170
ABN 16 140 787 195
Phone: +61 3 8562 2700



Note: Repairs to this product may be made only by the manufacturer and its authorized agents, or by others who are legally authorized. Unauthorized repair will void this express warranty.

APPENDIX A - TIME ZONE CODES

The following table identifies the time zone name and time zone code to use on the IP phone.

Time Zone Name/Time Zone Code Table

TIME ZONE NAME	TIME ZONE CODE
AD-Andorra	CET
AE-Dubai	GST
AG-Antigua	AST
AI-Anguilla	AST
AL-Tirane	CET
AN-Curacao	AST
AR-Buenos Aires	ART
AS-Pago Pago	BST
AT-Vienna	CET
AU-Lord Howe	LHS
AU-Tasmania	EST
AU-Melbourne	EST
AU-Sydney	EST
AU-Broken Hill	CST
AU-Brisbane	EST
AU-Lindeman	EST
AU-Adelaide	CST
AU-Darwin	CST
AU-Perth	WST
AW-Aruba	AST
AZ-Baku	AZT

Time Zone Name/Time Zone Code Table

TIME ZONE NAME	TIME ZONE CODE
BA-Sarajevo	EET
BB-Barbados	AST
BE-Brussels	CET
BG-Sofia	EET
BM-Bermuda	AST
BO-La Paz	BOT
BR-Noronha	FNT
BR-Belem	BRT
BR-Fortaleza	BRT
BR-Recife	BRT
BR-Araguaina	BRS
BR-Maceio	BRT
BR-Sao Paulo	BRS
BR-Cuiaba	AMS
BR-Porto Velho	AMT
BR-Boa Vista	AMT
BR-Manaus	AMT
BR-Eirunepe	ACT
BR-Rio Branco	ACT
BS-Nassau	EST
BY-Minsk	EET
BZ-Belize	CST
CA-Newfoundland	NST
CA-Atlantic	AST
CA-Eastern	EST
CA-Saskatchewan	EST
CA-Central	CST
CA-Mountain	MST
CA-Pacific	PST
CA-Yukon	PST
CH-Zurich	CET
CK-Rarotonga	CKS
CL-Santiago	CLS
CL-Easter	EAS
CN-Beijing	CST
CO-Bogota	COS
CR-Costa Rica	CST
CU-Havana	CST
CY-Nicosia	EES
CZ-Prague	CET

Time Zone Name/Time Zone Code Table

TIME ZONE NAME	TIME ZONE CODE
DE-Berlin	CET
DK-Copenhagen	CET
DM-Dominica	AST
DO-Santo Domingo	AST
EE-Tallinn	EET
ES-Madrid	CET
ES-Canary	WET
FI-Helsinki	EET
FJ-Fiji	NZT
FK-Stanley	FKS
FO-Faeroe	WET
FR-Paris	CET
GB-London	GMT
GB-Belfast	GMT
GD-Grenada	AST
GE-Tbilisi	GET
GF-Cayenne	GFT
GI-Gibraltar	CET
GP-Guadeloupe	AST
GR-Athens	EET
GS-South Georgia	GST
GT-Guatemala	CST
GU-Guam	CST
GY-Guyana	GYT
HK-Hong Kong	HKS
HN-Tegucigalpa	CST
HR-Zagreb	CET
HT-Port-au-Prince	EST
HU-Budapest	CET
IE-Dublin	GMT
IS-Reykjavik	GMT
IT-Rome	CET
JM-Jamaica	EST
JP-Tokyo	JST
KY-Cayman	EST
LC-St Lucia	AST
LI-Vaduz	CET
LT-Vilnius	EET
LU-Luxembourg	CET
LV-Riga	EET

Time Zone Name/Time Zone Code Table

TIME ZONE NAME	TIME ZONE CODE
MC-Monaco	CET
MD-Chisinau	EET
MK-Skopje	CET
MQ-Martinique	AST
MS-Montserrat	AST
MT-Malta	CET
MU-Mauritius	MUT
MX-Mexico City	CST
MX-Cancun	CST
MX-Merida	CST
MX-Monterrey	CST
MX-Mazatlan	MST
MX-Chihuahua	MST
MX-Hermosillo	MST
MX-Tijuana	PST
NI-Managua	CST
NL-Amsterdam	CET
NO-Oslo	CET
NR-Nauru	NRT
NU-Niue	NUT
NZ-Auckland	NZS
NZ-Chatham	CHA
OM-Muscat	GST
PA-Panama	EST
PE-Lima	PES
PL-Warsaw	CET
PR-Puerto Rico	AST
PT-Lisbon	WET
PT-Madeira	WET
PT-Azores	AZO
PY-Asuncion	PYS

Time Zone Name/Time Zone Code Table

TIME ZONE NAME	TIME ZONE CODE
RO-Bucharest	EET
RU-Kaliningrad	EET
RU-Moscow	MSK
RU-Samara	SAM
RU-Yekaterinburg	YEK
RU-Omsk	OMS
RU-Novosibirsk	NOV
RU-Krasnoyarsk	KRA
RU-Irkutsk	IRK
RU-Yakutsk	YAK
RU-Vladivostok	VLA
RU-Sakhalin	SAK
RU-Magadan	MAG
RU-Kamchatka	PET
RU-Anadyr	ANA
SE-Stockholm	CET
SG-Singapore	SGT
SI-Ljubljana	CET
SK-Bratislava	CET
SM-San Marino	CET
SR-Paramaribo	SRT
SV-El Salvador	CST
TR-Istanbul	EET
TT-Port of Spain	AST
TW-Taipei	CST
UA-Kiev	EET
US-Eastern	EST
US-Central	CST
US-Mountain	MST
US-Pacific	PST
US-Alaska	AKS
US-Aleutian	HAS
US-Hawaii	HST
UY-Montevideo	UYS
VA-Vatican	CET
YU-Belgrade	CET

